

HANDBOOK OF MODERN PHARMACEUTICAL ANALYSIS

Edited by Satinder Ahuja
and Stephen Scypinski

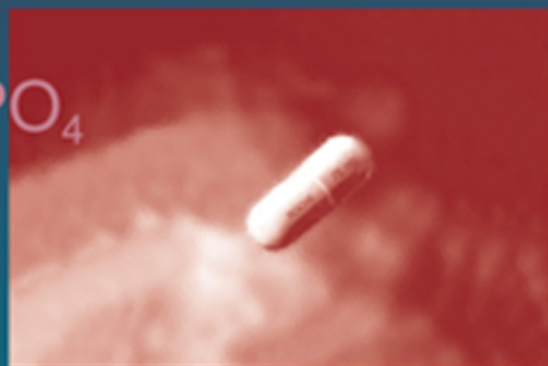
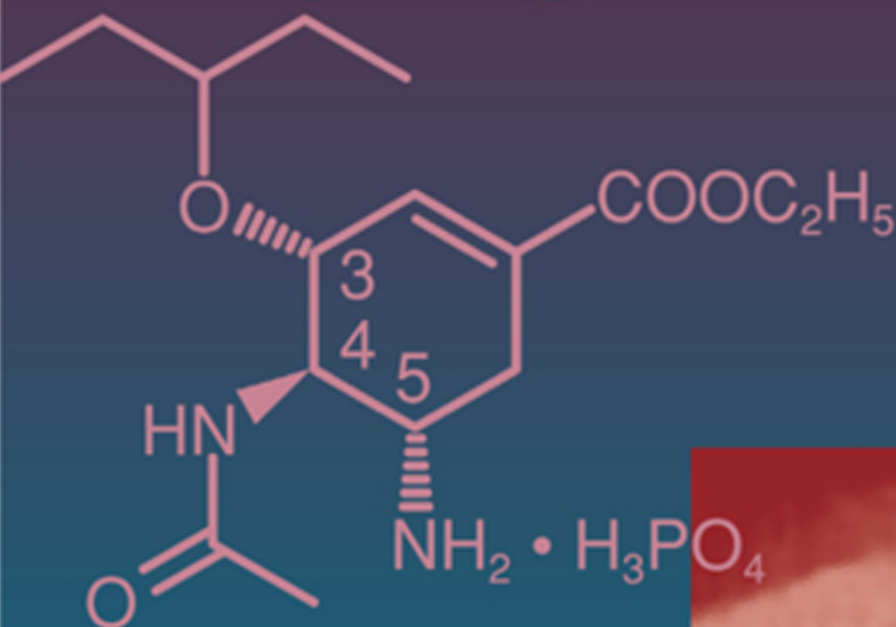

VOLUME 3

Series Editor **Satinder Ahuja**



SEPARATION SCIENCE AND TECHNOLOGY

**HANDBOOK OF MODERN
PHARMACEUTICAL ANALYSIS**

This Is Volume III of
SEPARATION SCIENCE AND TECHNOLOGY
A reference series edited by Satinder Ahuja

HANDBOOK OF MODERN PHARMACEUTICAL ANALYSIS

Edited by

Satinder Ahuja

*Ahuja Consulting
Calabash, North Carolina*

Stephen Scypinski

*RW Johnson Pharmaceutical Research Institute
Raritan, New Jersey*



ACADEMIC PRESS

A Harcourt Science and Technology Company

San Diego San Francisco New York Boston London Sydney Tokyo

This book is printed on acid-free paper. ☺

Copyright © 2001 by Academic Press

All rights reserved.

No part of this publication may be reproduced or transmitted in any form or by any means, electronic or mechanical, including photocopy, recording, or any information storage and retrieval system, without permission in writing from the publisher.

The appearance of the code at the bottom of the first page of a chapter in this book indicates the Publisher's consent that copies of the chapter may be made for personal or internal use of specific clients. This consent is given on the condition, however, that the copier pay the stated per-copy fee through the Copyright Clearance Center, Inc. (222 Rosewood Drive, Danvers, Massachusetts 01923), for copying beyond that permitted by Sections 107 or 108 of the U.S. Copyright Law. This consent does not extend to other kinds of copying, such as copying for general distribution, for advertising or promotional purposes, for creating new collective works, or for resale. Copy fees for pre-2001 chapters are as shown on the title pages; if no fee code appears on the title page, the copy fee is the same as for current chapters. 01 \$35.00.

The information provided in this handbook is compiled from reliable sources but the authors, editor, and the publisher cannot assume any responsibility whatsoever for the validity of all statements, illustrations, data, procedures, and other related materials contained herein or for the consequence of their use.

ACADEMIC PRESS

A Harcourt Science and Technology Company

525 B Street, Suite 1900, San Diego, CA 92101-4495, USA

<http://www.academicpress.com>

Academic Press

Harcourt Place, 32 Jamestown Road, London, NW1 7BY, UK

Library of Congress Catalog Number: 2001088201

International Standard Book Number: 0-12-045555-2

Printed in the United States of America

00 01 02 03 HP 9 8 7 6 5 4 3 2 1

CONTENTS

CONTRIBUTORS xiii

PREFACE xvii

I Modern Pharmaceutical Analysis: An Overview

SATINDER AHUJA

- I. Identity and Purity Requirements 2
- II. Bioavailability/Dissolution Requirements 4
- III. Regulatory Considerations 5
- IV. Regulatory Compliance 8
- V. International Conference on Harmonization 9
- VI. Global CMC NDA 9
- VII. Highlights of Modern Pharmaceutical Analysis 10
- References 22

2 Combinatorial Chemistry and High-Throughput Screening in Drug Discovery and Development

KEN APPELL, JOHN J. BALDWIN, AND WILLIAM J. EGAN

- I. Introduction 24
- II. Combinatorial Methods 25

- III. Methods for Structural Assignment 26
- IV. Diversity 28
- V. Druglikeness 28
- VI. Designing Combinatorial Libraries with Optimal ADME Properties 28
- VII. Existing Computational Methods for ADME Properties 30
- VIII. Optimization Philosophy 35
- IX. Applying Existing ADME Models to Combinatorial Library Design 37
- X. The Future of ADME Modeling 38
- XI. High-Throughput Screening and Combinatorial Chemistry 39
- XII. Assay Plate Formats: Move to Miniaturization 40
- XIII. Nonseparation or Homogeneous Assays 43
- XIV. Identification of Receptor Antagonists for Chemokine Receptor and Bradykinin-1 by Screening a 150,000-Member Combinatorial Library 44
- XV. Structure-based Design of Somatostatin Agonists 47
- XVI. Conclusions 48
- References 49

3 Solid-State Analysis

HARRY G. BRITAIN

- I. Introduction 57
- II. Properties Associated with the Molecular Level 58
- III. Properties Associated with the Particulate Level 65
- IV. Properties Associated with the Bulk Level 73
- V. Summary 81
- References 81

4 Degradation and Impurity Analysis for Pharmaceutical Drug Candidates

KAREN M. ALSANTE, ROBERT C. FRIEDMANN, TODD D. HATAJIK, LINDA L. LOHR,
THOMAS R. SHARP, KIMBERLY D. SNYDER, AND EDWARD J. SZCZESNY

- I. Residual Solvents and Water 86
- II. Purposeful Degradation Studies 95
- III. Isolation and Identification of Impurities/Degradants 119
- IV. Mass Spectrometry in Identification of Impurities 127
- V. Role of NMR 147
- VI. Reference Standards 166
- VII. Summary 168
- References 168

5 Preformulation Studies

EDWARD LAU (deceased)

- I. Introduction 173
- II. Preformulation Studies 180
- III. Analytical Techniques and Instruments for Preformulation Studies 214
- IV. Regulatory Requirements for Preformulation 224
- V. Summary and Conclusions 226
 - Appendix 1 227
 - Appendix 2 229
 - Appendix 3 232
 - References 232

6 Solid Dosage-Form Analysis

PHILIP J. PALERMO

- I. Introduction 235
- II. Physicochemical Characterization Techniques 241
- III. Near-Infrared Analysis 252
- IV. Automation 257
- V. Future Directions 262
- VI. Summary 263
- VII. Acknowledgments 263
 - References 263

7 Parenteral Dosage Forms

GREGORY A. BIRRER, SATYA S. MURTHY, AND JIE LIU

- I. Characteristics of Parenteral Dosage Forms 270
- II. Pharmaceutical Analysis During Formulation and Process Development 271
- III. Analytical Testing for Finished Parenteral Products 272
- IV. Packaging Components Testing 273
- V. Process Development Support 274
- VI. In-Process Testing 275
- VII. Release Testing 276
- VIII. Raw Material Testing 278
- IX. Validation of Analytical Procedure 279
 - X. Stability-Indicating Methods 281
 - XI. Method Transfer 281
 - XII. Cleaning Method Validation 282
- XIII. Admixture Studies 282
- XIV. Microbiological Testing of Parenteral Formulations 283
- XV. Sterility Testing 284

XVI. Bacterial Endotoxin Testing	290
XVII. Particulate Matter Testing	292
XVIII. Bioburden Testing of Parenteral Product Solution	294
XIX. Introduction to Cleaning Validation	298
XX. Swab Selection (Recovery and Compatability Studies)	298
XXI. Technician Qualification	298
XXII. Sampling	299
XXIII. Acceptance Criteria	300
XXIV. Methods of Analysis	301
XXV. Grouping/Matrix Approach	301
XXVI. Validation Protocol	302
XXVII. Validation Report	302
XXVIII. Summary	302
References	303

8 New Drug Delivery Systems

DAVID C. PANG

I. Introduction	307
II. Oral Drug Delivery	308
III. Direct Drug Delivery	310
IV. Dermatological Delivery System	311
V. Tumor-Targeted Drug Delivery Systems	311
VI. Biodegradable Drug Delivery System	313
VII. Protein Drug Delivery System	315
VIII. Devices	319
IX. Summary	323
References	323

9 Compendial Testing

CHRISTINE F. RICHARDSON

I. Introduction	325
II. A Brief History of the United States Pharmacopeia	326
III. Compendial Testing for Formulated Products and Active Ingredients	327
IV. Which Compendium to Use and When to Use It	340
V. Validation	340
VI. Harmonization of Testing Methods for Multicountry Submission	342
VII. Conclusions	343
VIII. Acknowledgments	344
References	344

10 Method Development

HENRIK T. RASMUSSEN

- I. Introduction 345
- II. Overview of Separation Methods 346
- III. High-Performance Liquid Chromatography 349
- IV. Thin-Layer Chromatography 374
- V. Gas Chromatography 375
- VI. Supercritical-Fluid Chromatography 376
- VII. Capillary Electrophoresis 379
- VIII. Conclusions 383
- IX. Summary 383
- References 384

11 Setting Up Specifications

IAN E. DAVIDSON

- I. Introduction 387
- II. Setting Specifications at Different Stages of Drug Development 389
- III. International Conference on Harmonization Guidelines 393
- IV. Pharmacopeias and Specifications 410
- V. Statistical Considerations in Setting Specifications 411
- VI. Summary 412
- References 412

12 Validation of Pharmaceutical Test Methods

JONATHAN B. CROWTHER

- I. Background and Chapter Overview 415
- II. Validation Terminology and Definitions 418
- III. Method Development and Its Influence on Method Validation 419
- IV. Validation Requirements of The Method 428
- V. Validation Documentation 428
- VI. Validation Experimentation 429
- VII. Method Transfer 436
- VIII. Revalidation 438
- IX. Reference Standards 438
- X. Summary 441
- Acknowledgments 442
- References 442

13 Stability Studies

JESSICA CHA, JOSEPH S. RANWEILER, PHILIP A. LANE

- I. Introduction 445
- II. Operational Issues 446
- III. Excipients 461
- IV. Drug Substance 463
- V. Drug Product 471
- VI. Summary 480
- Glossary 480
- Appendix 482
- References 483

14 Analytical Methodology Transfer

STEPHEN SCYPINSKI

- I. Introduction 485
- II. The Drug Development Process 486
- III. Types of Method Transfer 487
- IV. Requirements and Elements of Analytical Technology Transfer 489
- V. Technical Transfer Time Line/Project Plan 492
- VI. Analysis of Results/Statistical Packages 493
- VII. Analyst Certification and Training 494
- VIII. Transfer of Technical Ownership 494
- IX. Chapter Summary 497
- References 497

15 Pharmaceutical Analysis Documentation

HITESH CHOKSHI AND KATHLEEN SCHOSTACK

- I. Scope 499
- II. Introduction 500
- III. Pharmaceutical Analysis During Product Life Cycle 500
- IV. Regulatory Documents 510
- V. Compliance Documents 516
- VI. Research Documents 520
- VII. Summary 521
- VIII. Conclusions 522
- Appendix I: References for CMC Guidances 522
- Appendix II: U.S. NDA Table of Contents—Analytical Documentation 525

16 An Innovative Separation Platform: Electrophoretic Microchip Technology

LIAN JI JIN, JEROME FERRANCE, ZHILI HUANG, AND JAMES P. LANDERS

- I. Introduction 529
- II. Microchip Fabrication 531
- III. Detection Techniques 535
- IV. Pharmaceutical Potential 545
- V. Concluding Remarks 549
- VI. Summary 549
 - References 549

INDEX 555

This Page Intentionally Left Blank

CONTRIBUTORS

Numbers in parentheses indicate the pages on which the authors' contributions begin.

Satinder Ahuja (1) Ahuja Consulting, 330 Middleton Drive, Suite 803, Calabash, North Carolina 28467

Karen M. Alsante (85) Pfizer Global Research and Development Division, Analytical Research and Development, P.O. Box 4077, Pfizer Inc., Eastern Point Road, Groton, Connecticut 06340

Ken Appell (23) Pharmacopeia, Inc., P.O. Box 5350, Princeton, New Jersey 08543-5350

John J. Baldwin (23) Pharmacopeia, Inc., P.O. Box 5350, Princeton, New Jersey 08543-5350

Gregory A. Birrer (269) Baxter Anesthesia Critical Care, Baxter Healthcare Medication Delivery, 95 Spring Street, New Providence, New Jersey 07974

Harry G. Brittain (57) Center for Pharmaceutical Physics, 10 Charles Road, Milford, New Jersey 08848

Jessica Cha (445) The R. W. Johnson Pharmaceutical Research Institute, P.O. Box 300, Route 202, Raritan, New Jersey, 08869

Hitesh Chokshi (499) Hoffmann-La Roche, Inc. 340, Kingsland Street, Nutley, New Jersey 07110

- Jonathan B. Crowther** (415) Ortho-Clinical Diagnostics, 1001 U.S. Highway 202, Raritan, New Jersey, 08869-0606
- Jan E. Davidson** (387) Aventis Pharmaceuticals, P.O. Box 6800, Route 202-206, Bridgewater, New Jersey 08560
- William J. Eagan** (23) Pharmacopeia, Inc., P.O. Box 5350, Princeton, New Jersey 08543-5350
- Judy Estrada** (269) Gensia-Sicor Pharmaceuticals, 19 Hughes Street, Irvine, California 92618-1902
- Jerome Ferrance** (ch. 16) Department of Chemistry, University of Virginia, McCormick Road, Charlottesville, Virginia 22901
- Robert C. Friedmann** (85) Pfizer Global Research and Development Division, Process Research and Development, P.O. Box 4077, Pfizer Inc., Eastern Point Road, Groton, Connecticut 06340
- Todd D. Hatajik** (85) Pfizer Global Research and Development Division, Analytical Research and Development, P.O. Box 4077, Pfizer Inc., Eastern Point Road, Groton, Connecticut 06340
- Zhili Huang** (529) Department of Chemistry, University of Virginia, McCormick Road, Charlottesville, Virginia 22901
- Lian Ji Jin** (ch. 16) Department of Chemistry, University of Virginia, McCormick Road, Charlottesville, Virginia 22901
- James P. Landers** (529) Department of Chemistry, University of Virginia, and Department of Pathology, University of Virginia Health Science Center, Charlottesville, Virginia 22901
- Philip A. Lane** (445) The R. W. Johnson Pharmaceutical Research Institute, P.O. Box 300, Route 202, Raritan, New Jersey 08869
- Edward P. Lau** (173) (deceased) E. L. Associates, 102 Lanark Road, Wilmington, Delaware 19807
- Jie Liu** (269) Baxter Anesthesia Critical Care, Baxter Healthcare Medication Delivery, 95 Spring Street, New Providence, New Jersey 07974
- Linda L. Lohr** (85) Pfizer Global Research and Development Division, Analytical Research and Development, P.O. Box 4077, Pfizer Inc., Eastern Point Road, Groton, Connecticut 06340
- Satya S. Murthy** (269) Baxter Anesthesia Critical Care, Baxter Healthcare Medication Delivery, 95 Spring Street, New Providence, New Jersey 07974
- Philip J. Palermo** (235) Purdue Pharma L. P., 444 Saw Mill River Road, Ardsley, New York 10502
- David C. Pang** (307) American Association of Pharmaceutical Scientists, 2107 Wilson Boulevard, #700, Arlington, Virginia 22201-3046
- Joseph S. Ranweiler** (445) The R. W. Johnson Pharmaceutical Research Institute, P.O. Box 300, Route 202, Raritan, New Jersey 08869
- Henrik T. Rasmussen** (345) Analytical Chemistry Research and Development, The R. W. Johnson Pharmaceutical Research Institute, 1000 Route 202, Raritan, New Jersey 08869

Christine F. Richardson (325) Quality Assurance, Novartis Pharmaceuticals Corporation, 25 Old Mill Road, Suffern, New York 10901

Thomas R. Sharp (85) Pfizer Global Research and Development Division, Analytical Research and Development, P.O. Box 4077, Pfizer Inc., Eastern Point Road, Groton, Connecticut 06340

Kathleen Schostack (499) Hoffmann-La Roche, Inc. 340 Kingsland Street, Nutley, New Jersey 07110

Kimberly D. Snyder (85) Pfizer Global Research and Development Division, Analytical Research and Development, P.O. Box 4077, Pfizer Inc., Eastern Point Road, Groton, Connecticut 06340

Edward J. Szczesny (85) Pfizer Global Research and Development Division, Analytical Research and Development, P.O. Box 4077, Pfizer Inc., Eastern Point Road, Groton, Connecticut 06340

Stephen Scypinski (485) Analytical Chemistry Research and Development, The R. W. Johnson Pharmaceutical Research Institute, P.O. Box 300, Route 202, Raritan, New Jersey 08869

This Page Intentionally Left Blank

PREFACE

Today, modern pharmaceutical analysis entails much more than the analysis of active pharmaceutical ingredients or the formulated product. There are many reasons for this change, not the least of which is our ability to better understand physicochemical properties of pharmaceutical compounds through the use of advanced instrumental methods. Furthermore, there is a need for quality assurance of pharmaceutical products throughout their shelf life. This requires that we study interactions of the drug substance with the excipients in the presence of residual solvents, as well as other potential degradation reactions that may occur in the formulated product over a period of time under various stress conditions (these include conditions they may be subjected to during storage or shipment in the final package configuration).

The pharmaceutical industry is under increased scrutiny from the government and public interest groups to contain costs and yet consistently deliver to market safe, efficacious products that fulfill unmet medical needs. As part of the crusade to hold the line on prescription drug prices, the industry has streamlined its operations with respect to drug discovery, development, and manufacturing. The drive to bring innovative products to market faster without negatively impacting quality or safety has caused every company to challenge all existing processes and to look for ways to increase capacity, shorten time lines, and “do more with less.” Coupled with this initiative is the migration of companies from functional arrangements to team-based organizational structures.

Analytical chemistry has played a major role in the changes facing the pharmaceutical industry today. Traditionally viewed as a service organization, the analytical department has become a significant partner in the drug development process. Indeed, the demand for analytical data has become a critical path activity for the selection of candidate molecules for full development. Working under sample-limited conditions and in full compliance of current good manufacturing practices (cGMP), pharmaceutical analysts are called on to generate accurate and precise data—almost on demand. The science and technology utilized today, coupled with the new regulations that are now binding, have made pharmaceutical analysis much more complicated compared to what it was as little as ten years ago.

This text fills the need for a handbook that is current with respect to the philosophy of analytical chemistry support for drug discovery, development, and post-market support. It is our intention to present the role of analytical research and development as a part of the overall process. For this reason, the chapters are organized in more of a process-driven manner rather than pure function or technique. In all cases, a large number of references are provided for those readers desiring a more in-depth discussion of a particular subject.

The pharmaceutical analyst plays a major role in assuring identity, safety, efficacy, purity, and quality of a drug product. Safety and efficacy studies require that drug substance and drug product meet the established identity and purity as well as bioavailability/dissolution requirements (Chapter 1). The need for pharmaceutical analysis is driven largely by regulatory requirements. This stems from the fact that regulatory considerations loom large when a commercial product does not meet its purported quality. Regulatory requirements and compliance issues have been discussed thoroughly in this book. Significant discussion has also been provided regarding the International Conference on Harmonization (ICH) that has attempted to harmonize the requirements by regulatory authorities in the United States, Europe, and Japan.

New drug discovery and candidate optimization processes in the pharmaceutical industry are being extensively carried out these days with combinatorial chemistry coupled with high-throughput screening (Chapter 2). Also, lately an increasing degree of attention is being given to the physical properties of the solids that can compromise a dosage form (Chapter 3). Good understanding of physicochemical behavior of pharmaceutical solids ensures a better selection of formulation. The selection process includes identification of process-related impurities and products and studying degradation mechanisms at an early stage. This allows adequate time for improvements in the drug substance synthesis and formulation to prevent the occurrence of these impurities and degradation products (Chapter 4).

Preformulation studies are conducted to provide data and information about a drug substance and manufacturing technology prior to initiation of formulation development and drug product designing activities (Chapter 5). The pharmaceutical analysis of finished solid oral dosage forms is discussed in Chapter 6 from the standpoint of what makes this type of delivery form unique and successful. The development process for parenteral dosage forms is covered in Chapter 7, with emphasis on the bulk drug substance, excipients, in-process analysis, and final dosage form analysis.

The most common route of administration of drugs is by oral cavity. Other routes of administration of pharmaceutical products are rectum, nose, skin, and eye. Drug delivery via intravenous, intramuscular, subcutaneous, and peritoneal administration requires training, supervision, and skilled personnel. New and promising drug-delivery systems have been created and modified to ensure that drugs are delivered to the appropriate targets of action in the body for maximum efficacy. Such novel delivery systems pose special analytical challenges (Chapter 8). The commonly used tests of pharmaceutical analysis generally entail compendial testing; these methods, method development, setting specifications, and method validation are discussed at length in Chapters 9–12. The legal requirements of stability are aimed at ensuring that the drug product remains within specifications established to ensure its identity, strength, quality, and purity. It is necessary to conduct stability studies to predict, evaluate, and ensure drug product safety (Chapter 13). Successful transfer of analytical methodology for a new drug product depends heavily on having the right process; this is discussed at length in Chapter 14.

Pharmaceutical analytical documentation reflects the key functions of analytical research and development: to monitor and ensure the identity, purity, stability, and consistency of drug substance and dosage forms used during preclinical, clinical, and marketing phases in accordance with the governing regulatory guidance and policies (Chapter 15). These data are almost always requested during pre-approval inspections (PAIs). Analytical data are the foundation and backbone for pharmaceutical development, leading to approval and production of new drugs for market. Documentation of this data provides the critical links during the evolution and life cycle of a new pharmaceutical product—beginning from earliest studies, enabling entry into humans, through product launch and post-approval changes. New analytical platforms such as miniaturized chemical analysis systems are very desirable in separation science, as they help work with smaller sample size, while gaining high speed and high-throughput separations without compromising resolution and detection sensitivity (Chapter 16). Furthermore, they can help reduce the consumption of various reagents and organic solvents, thus helping to control the cost of disposal and to be environment-friendly. The current state-of-the-art design and fabrication aspects of microfabricated electrophoresis devices are reviewed, as well as development of popular detection modes applicable to chip devices. Potential areas in pharmaceutical analysis are highlighted, based on the successful demonstration made with analysis of proteins, peptides, DNA, and small molecules including chiral separations.

We believe that the valuable information presented by the contributors to this book will be found useful by those involved in various aspects of pharmaceutical analysis as they relate to new drug development, production and control, teaching, or regulation.

Satinder Abuja
Stephen Scypinski

This Page Intentionally Left Blank

MODERN PHARMACEUTICAL ANALYSIS: AN OVERVIEW

S. AHUJA

Abuja Consulting, Calabash, North Carolina 28467

- I. IDENTITY AND PURITY REQUIREMENTS
 - II. BIOAVAILABILITY/DISSOLUTION REQUIREMENTS
 - III. REGULATORY CONSIDERATIONS
 - IV. REGULATORY COMPLIANCE
 - V. INTERNATIONAL CONFERENCE ON HARMONIZATION
 - VI. GLOBAL CMC NDA
 - VII. HIGHLIGHTS OF MODERN PHARMACEUTICAL ANALYSIS
 - A. Discovery of NCE and High-Throughput Screening
 - B. Solid-State Studies on Drug Substances
 - C. Degradation and Impurity Analysis of Drug Substances
 - D. Preformulation Studies
 - E. Solid Oral Dosage Forms
 - F. Parenteral Dosage Forms
 - G. Developing New Dosage Forms
 - H. Compendial Testing
 - I. Method Development
 - J. Setting Specifications
 - K. Method Validation
 - L. Stability Studies
 - M. Analytical Methodology Transfer
 - N. Documentation and Inspection
 - O. Innovative Analytical Platforms
- REFERENCES

Pharmaceutical analysis simply means analysis of a pharmaceutical(s). Webster's dictionary defines a pharmaceutical as a medicinal drug. It is generally known that a pharmaceutical is a chemical entity of therapeutic interest. A more appropriate term for a pharmaceutical is active pharmaceutical ingredient (API) or active ingredient. In colloquial terms, it is simply referred to as "active"; the use of this term is not encouraged. Even though the term active ingredient is more frequently used, the preferred term is active pharmaceutical ingredient. To distinguish it from the formulated product or drug product, API is also called drug substance. The drug product is prepared by formulating a drug substance with inert ingredients (excipients) to prepare a drug product that is suitable for administration to patients. So it is the drug product that is more likely to be administered to a patient as a medicinal drug than a drug substance by itself. However, it should be recognized that there are situations where a drug substance can be administered after simple dissolution

in a solvent such as water. Even in these situations, a suitable pharmaceutical treatment has to be conducted to assure availability and other safety considerations. The various terms mentioned here for API or formulated drug product are used interchangeably in this book; however, it is well known that drug substance and drug product are the preferred terms in regulatory circles.

This book describes what constitutes modern pharmaceutical analysis and the demands made on pharmaceutical analysts, and shows how these demands are effectively met. It is well known in the pharmaceutical industry that pharmaceutical analysts in research and development (R&D) play a very comprehensive role in new drug development and follow-up activities to assure that a new drug product meets the established standards, is stable, and continues to meet the purported quality throughout its shelf life. After the drug product is approved by regulatory authorities, assuring that all batches of drug product are made to the specified standards, utilization of approved ingredients and production methods becomes the responsibility of pharmaceutical analysts in the quality control (QC) or quality assurance (QA) department. The methods are generally developed in an analytical R&D department and transferred to QC or other departments, as needed. At times, they are transferred to other divisions located nationally or abroad or to outsourced companies.

By now it should be quite apparent that pharmaceutical analysts play a major role in assuring the identity, safety, efficacy, and quality of a drug product. Safety and efficacy studies require that drug substance and drug product meet two critical requirements:

- Established identity and purity
- Established bioavailability/dissolution

I. IDENTITY AND PURITY REQUIREMENTS

A pharmaceutical analyst initially interfaces and interacts with various departments and professionals from several disciplines to provide input that assure that the new chemical entity (NCE) or new molecular entity (NME) indeed has the proposed structure and defined requisite purity. This also ensures that no undesired side effects from various impurities, which may be contaminants, by-products, interaction products, or degradation products, are encountered.¹ The new drug development process can be accelerated by the use of combinatorial chemistry and high-throughput screening (Chapter 2). Next, it is important to assure that the developed drug product meets the essential quality requirements and that quality is maintained until the drug is finally administered to the patient. As a result, a battery of tests must be developed that relate to the nature of the material being tested and the stage in its development. For example, the small quantity of material initially prepared by the discovery scientist generally has no history: The only information regarding impurities and testing methodology can be deduced from its structure and mode of preparation. Tests have to be developed based on this limited information. As future batches are developed, more historical information becomes available. However, it is not uncommon to change the mode of preparation of the drug substance and

the drug product to improve the quality or for economic reasons. Hence, the methodology has to be constantly improved and/or modified to accommodate these developments. As a matter of fact, phase-appropriate methods should be developed (Chapter 10). The four phases of clinical drug development are generally denoted as follows:

- Phase I. Safety in healthy subjects
- Phase II. Safety and efficacy in patients
- Phase III. Definitive clinical efficacy studies
- Phase IV. Post-new drug application (NDA) approval studies

A drug substance can be formulated into various drug products based on the input of various departments after thorough consideration of the desired dosage and target site. However, marketing considerations often play a significant role in the selection process, which frequently raises some new considerations. The commonly used dosage forms are tablets or capsules that are administered orally (Chapter 6); at times, injectables are used (Chapter 7). However, a number of other new dosage forms may be more desirable than the conventional forms and should be considered (Chapter 8). It is important that pharmaceutical analysts be well acquainted with new dosage forms and provide the necessary important input to assure quality and safety of the drug product to arrive at a final drug product for which an investigational new drug (IND) application or NDA can be filed with the local regulatory authorities of a country (e.g., the Food and Drug Administration in the United States) for a product that will be eventually commercialized. These inputs also have to be made throughout the drug development process, including development of materials for toxicologic, pharmacologic, and clinical studies.

This book provides a realistic view of the art and science of modern pharmaceutical analysis. Pharmaceutical analysis very rarely constitutes only testing a sample against written directions without vigilant independent observations. This should not be the case even in the quality control environment, where it is frequently assumed that testing is done per recipe. If this were the case, a lot of problems would go unnoticed because batch-to-batch variations can be encountered even under the best production environment. In analytical research and development, flexibility, vigilance, and creativity is the name of the game. The emphasis must be on finding the optimal methodology that monitors all known and unknown impurities. This is a daunting task because unknown impurities have to be theorized based on the best knowledge of reaction and degradation chemistry, combined with sound knowledge of physical organic chemistry to theorize potential reactions and interactions of molecules that could be involved in the material (drug substance, pharmaceutical aids, and solvents used for the preparation of the drug product). Furthermore, the changes that could occur during storage in various containers or packages and the effect of a variety of storage environments must be considered. Beyond that, any changes in process and ingredients have to be continually monitored to assure the quality and the safety of the drug product. There is a very important need to document observations so that their importance is reflected in various written reports (Chapter 15). Methodologies and specifications that evolve out of considerations of quality, historical information, and regulatory

considerations are documented and validated to assure that the methodologies are rugged and robust, so that they can be reproduced day to day within the same laboratory or in other laboratories. It is also very important to assure that the product has the desired bioavailability.

II. BIOAVAILABILITY/DISSOLUTION REQUIREMENTS

The therapeutic dosage of a drug product should be fully available when it is administered to patients. The crystal form of a drug substance and the formulation can influence bioavailability (Chapter 3). To assure bioavailability of commercially produced batches of a drug product, it is important to develop an *in vitro* dissolution test, which is equivalent to the *in vivo* test for bioavailability. It should be clear that such a test would be ideal for monitoring drug product and batch-to-batch variability. Disintegration, dissolution, and drug-release tests are *in vitro* tests included in the United States Pharmacopoeia (USP). These tests are designed to monitor availability whenever it can be achieved for the purpose of routine quality control or, at minimum, to monitor batch-to-batch variabilities. The dissolution test has been applied quite successfully as a QC test to assure consistency of manufacture. These tests are often labor-intensive and, therefore, represent the greatest opportunity for modernization and automation (Chapter 6).

The importance of dissolution testing to the pharmaceutical industry is reflected by the fact that the USP lists at least seven different laboratory apparatuses for the determination of *in vitro* release rates of drugs from their pharmaceutical dosage forms. USP apparatuses 1 (baskets) and 2 (paddles) have dominated the applications for solid oral dosage forms, but recently there has been an increase in the use of apparatus 4 (flow-through cell). Although general guidelines exist with regard to the dissolution media, volume, stirring rate, and temperature to be used with each type of apparatus, the choice of conditions should be based entirely on the ability to detect product variation, stability changes, polymorphic changes, and correlation with *in vivo* results in situations where these studies are performed.

These initiatives were the subject of many recent workshops attended by worldwide representatives from industry, academia, and regulatory agencies. Although the establishment of a good *in vitro*–*in vivo* correlation can be a significant undertaking on the part of the analytical, pharmaceuticals, and biopharmaceuticals departments, it can provide a great advantage to the sponsor company. In situations that involve formulation, process, equipment, and site of manufacture changes, expensive and time-consuming bioequivalence studies may be waived in lieu of equivalent dissolution results that use the established *in vitro*–*in vivo* correlation method.

III. REGULATORY CONSIDERATIONS

In an ideal world, the need for analysis should be driven by the desire to assure the quality of a drug product. However, in the real world the need for pharmaceutical analysis is driven largely by regulatory requirements. This stems

from the fact that regulatory considerations loom large when a commercial product does not meet its purported quality. A close examination of new drug product development reveals that quality cannot be tested into the product; it has to be built into it. This means that a great deal of consideration has to go in from the very start, when the NCE is developed to assure that it has the proposed structure, crystal form (if more than one crystal form is encountered, it is important to indicate which crystal form will be used in the drug product), and stereochemical structure. Additionally, it is critical that it meet high quality standards necessary for a product that is to be administered to humans.

The FDA perspective is summarized in the following list to give the reader a bird's-eye view of what is likely to be required by various regulatory agencies for the stereochemistry of NCEs that have one or more chiral centers.²

- All chiral centers should be identified.
- The enantiomeric ratio should be defined for any admixture other than 50:50.
- Proof of structure should consider stereochemistry.
- Enantiomers may be considered impurities.
- Absolute configuration is desirable for an optically pure drug.
- Marketing an optical isomer requires a new NDA.
- An IND is required for clinical testing.
- Justification of the racemate or any of the optically active forms must be made with the appropriate data.
- Pharmacokinetic behavior of the enantiomers should be investigated.

The requirements based on the International Conference on Harmonization guidelines are discussed in Section V. Many of the requirements that are now specified by regulatory authorities are nothing but a common-sense approach to assure that testing is performed at appropriate stages where the process changes can influence quality. Of necessity, the methods developed have to be sufficiently selective and sensitive to monitor the known and unknown impurities, have to be written in a format such that they can be reproduced by others, and have to be robust and rugged so that they can be reproduced over a period of time and from laboratory to laboratory. Another way to say this is that the methods should be validated. The fact that these are common-sense requirements is also obvious from the terminology used, such as good manufacturing practices (GMP) or good laboratory practice (GLP). It must be recognized that GLP was first introduced to control tests performed for biological studies.

The FDA has the assigned responsibility of ensuring the safety and efficacy of drugs. This requires that an IND be filed with the FDA prior to initiation of any clinical studies. An NDA has to be filed and approved before a drug can be commercialized. Information on the chemistry, manufacturing, and control (CMC) has to be filed in the IND as per 21 CFR 312.23(a) for a drug substance and drug product.³ A complete list of documents required for new drug development during pre-IND studies (Phase 0) and various phases of IND as well as NDA are given in Table 1 of Chapter 15. The following important

information has to be generated and filed with the regulatory authorities in the United States:

Drug Substance

- Specifications and test methods for drug substance, drug product, and placebo
- Rationale for IND specifications
- Method validations
- Batch profile for toxicologic and clinical batches
- Characterization of reference standard for purity, impurity, and physicochemical properties related to bioavailability
- Physicochemical properties of drug substance, including rationale for selection of polymorphic and salt form, if applicable
- Stability data
 - Stress study data for drug substance
 - Data from accelerated and long-term studies
- Certificate of analysis for drug substance and drug product to be used in the clinic

Drug Product

- Components and quantitative composition
 - Excipients
 - Solvents, if any
- Manufacturer
 - Name and address
- Manufacturing and packaging
 - Manufacturing procedure
 - Container description/specification
- Specification and analytical methods
 - Quality standards/batch analyses
- Excipient controls
 - Quality standards/batch analyses
 - Compendial certification
 - Additional controls, if any
- Stability
 - Stability report

It is important to keep current with regulations. Generally this information can be obtained from the FDA Web site, www.fda.gov. Furthermore, it is important to remember that the requirements for pharmaceutical analysis are controlled by the current good manufacturing practices (cGMP). The production of a drug product is also controlled by cGMP and covers the following elements:

- Organization and personnel
- Building and facilities
- Equipment
- Control of components, drug product containers, and closures
- Production and process controls
- Packaging and labeling controls
- Handling and distribution
- Laboratory controls
- Records and reports

It should be recognized that setting limits on impurities in drug substances is an evolutionary process, beginning before an IND is filed and continuing until well after the approval of an NDA. Therefore, it may be appropriate to address different stages in drug development as separate issues. There are a number of points in the drug development process where setting limits may be significantly different:

- Initial IND filing
- NDA filing
- After NDA approval
- Abbreviated new drug application (ANDA) filing

The filing of an ANDA is another activity in which limits are set on impurities. It is important to ensure that analytical methods used to evaluate impurities in drug substances are suitable for the intended purpose at each stage in development.

It should be noted that the regulatory authority in each country still has the major say in the requirements within its territorial control even though the US FDA seems to exercise a significant influence on the regulatory requirements of other countries. Finally, it may be instructive to review the top reasons for product recalls based on a report from the FDA Center for Drug Evaluation and Research Office of Compliance:

- Fails dissolution test
- Has label mix-up
- Deviates from cGMP standards
- Is a subpotent single-ingredient drug
- Expiration date not supported by stability data
- Lacks stability
- Is a superpotent single-ingredient drug
- Fails content uniformity
- Marketed without NDA/ANDA approval
- Exhibits microbial contamination of nonsterile products

Where deemed appropriate, the regulatory requirements and necessary documentation that must be filed with the IND and the NDA are further discussed in some detail in various chapters in this book.

IV. REGULATORY COMPLIANCE

A good foundation for regulatory compliance begins with well thought-out and established quality and compliance systems and practices within an organization. A team consisting of R&D, QC, and QA unit members develops these systems. It should be one of the highest priorities of top management and QA units to develop and monitor these systems to comply with the cGMP and GLP expectations.

Compliance documents are needed, in addition to the regulatory and research documents, to demonstrate the integrity of the data. Compliance documents refer to those reports required by GMP and/or utilized during the course of inspection by a health authority (Chapter 15).

Both general inspections and product-specific preapproval inspections focus on documents related to the quality systems and the product-specific controls and integrity of the analytical data. The main difference between the two types of inspections is the emphasis. General GMP inspections begin with an audit of the underlying compliance systems and standard operating procedures (SOPs), evaluating selected product-specific data as representative of compliance with those systems. The initial concern of the investigations is product-specific data and evaluation of some aspects of the compliance systems to gauge overall compliance with GMP.

Technology transfer documents (Chapters 14 and 15) are some of the most carefully reviewed documents during an inspection. Responsibilities for analytical support of a new drug are often transferred to other sites or other departments. Typically, there is at least one transfer between the analytical R&D group at the development site(s) and the QC unit at the launch site(s). Other technology transfers may arise because of the firm's functional organization or changes in supply strategy. The development history and knowledge must accompany the transfer of responsibilities.

It is extremely beneficial to have a comprehensive analytical development report that provides the scope of each analytical method, chronology, rationale for changes, and equivalency or superiority of the optimized methods. Usually, the analytical development report for each method, along with the validation report, facilitates the technology transfer process.

Compliance members, with the help of analytical members of the preapproval audit inspection team, audit the following product-specific documents:

- CMC NDA documentation and supporting data prior to filing, to ensure that all data and reports to be submitted in the NDA are accurate and complete
- Lab notebooks and certificates of analysis for reference standards, clinical and registration batches, etc.
- Updated stability reports
- Analytical methods validation and technology transfer reports for drug substance and drug product
- Specifications and analytical validation (including raw materials, packaging components)

- Available analytical data
- Laboratory investigations and investigation reports
- Cleaning validation

A product-specific checklist should be prepared to assist in preparation for a preapproval inspection.

V. INTERNATIONAL CONFERENCE ON HARMONIZATION

Significant discussion has been provided from the International Conference on Harmonization (ICH), which attempted to harmonize the requirements of regulatory authorities in the United States, Europe, and Japan (Chapters 6, 9, 11, and 15).

The ICH guidelines address the following important issues:

- Stability testing
- Analytical method validation
- Impurity testing
- Pharmacopoeial harmonization
- Quality of biotechnological and biological products
- Specifications: test procedures and acceptance criteria for new drug substances and new drug products

The last two topics are discussed in Chapter 11. The guidelines introduce the following universal tests (the tests that generally would be applied without exception):

- Description
- Identification
- Assay
- Impurities

Chiral impurities present a particularly difficult problem; however, the specification guidelines require the following conditions:

- For a single isomer, the other isomer is considered to be an impurity.
- An enantioselective determination should be part of the specifications.
- The identity test should be capable of distinguishing between a single enantiomer and its opposite enantiomer.
- Control of the other isomer is necessary if it is a degradation product.

Further information on ICH can be found at the International Federation of Pharmaceutical Manufacturers Association Web site, www.ifpma.org.

VI. GLOBAL CMC NDA

Efforts are currently under way within ICH to develop a common technical document (CTD) that will harmonize the CMC regulatory requirements for global development and marketing. Although some progress has been made

with respect to a harmonized table of contents, much remains to be done to harmonize the format and contents of the global NDA. Until more common areas are developed within the CTD, some assistance/recommendations are provided by the existing ICH quality guidelines.

Preparation of the CMC sections according to European Union (EU) and US guidelines results in two formally different NDAs. The contents for the CMC sections of the EU and US NDAs are very much the same. However, the sequence and titles of the sections are quite different. Because of the similarity in content, a modular approach may be used to create a global NDA. The CMC section for a global NDA will consist of a complete set of modules, where each module is global in its content, that is, each module contains the information required in both regions. Some additional country-specific documents (e.g., application summary, environmental assessment and method validation package for US, and expert reports for EU) still need to be prepared, but many of the other technical reports may be suitable for both dossiers by simply changing their order. The final EU or US NDA will consist of a specific arrangement of the modules with the appropriate (country-specific) headings. This modular approach reduces the redundancy and effort in preparing documents.

VII. HIGHLIGHTS OF MODERN PHARMACEUTICAL ANALYSIS

In addition to the number of activities already discussed, modern pharmaceutical analysis entails the following activities that are highlighted in this book:

- Discovery of NCE and high-throughput screening
- Solid-state analysis of drug substances
- Degradation and impurity analysis of drug substances
- Preformulation analysis
- Analysis of solid oral dosage forms
- Analysis of injectable dosage forms
- Development of new dosage forms
- Compendial testing
- Method development
- Setting specifications
- Method validation
- Stability studies
- Analytical methodology transfer
- Documentation and inspections
- Innovative analytical platforms

A. Discovery of NCE and High-Throughput Screening

Our present state of knowledge requires that a large number of molecules be prepared and tested before a successful potential candidate can be identified. This makes the drug discovery process very complex and cumbersome. It is worthwhile to remember that an ideal potential drug candidate should

be well absorbed orally, sufficiently metabolically stable to induce the desired pharmacologic effects, nontoxic; and cause minimal or no adverse effects, distribute selectively to target tissue(s), and have a reasonably long half-life (Chapter 2). A large number of compounds (around 80%) fail in an IND stage, and the success rate is around 1% for compounds that pass from drug discovery to approved NDA. As a result, the cost of development of a new drug has been estimated to be 300 million to 500 million US dollars. Combinatorial chemistry allows production of a large number of related compounds. Recent innovations in combinatorial chemistry have enabled the synthesis of large collections of libraries, which have led to current efforts to develop methods capable of screening these compounds. Combinatorial chemistry coupled with high-throughput screening (HTS) and computational methods has been integrated into the lead discovery and optimization process throughout the pharmaceutical industry. Assay miniaturization has allowed assay screening throughput to dramatically increase in recent years. Miniaturization has resulted in a reduction in cost per analysis in terms of manpower, less time to complete the screening cycle, and reduced requirements for compound and assay reagents. With HTS to help identify more and more leads, efforts will have to focus on relieving downstream bottlenecks in drug adsorption, metabolism, and toxicology. Consideration of druglike properties present in the library members during library design is one of the initial steps that can be taken to enhance the quality of leads identified from HTS. As computational and experimental procedures for absorption, distribution, metabolism, and excretion/toxicology improve, the identification of problematic leads earlier in the drug discovery process is possible. The powerful combination of innovations in chemical synthesis and library design, coupled with screening and bioinformatics technology can greatly help to decrease drug development times and costs.

B. Solid-State Studies on Drug Substances

The most commonly used method of administration for the majority of pharmaceutically active agents is as solid dosage forms, and these units are ordinarily produced by the formulation and processing of powdered solids. Until recently, the priority of regulatory bodies had always been to focus on concerns of safety and efficacy, which led to the required emphasis on aspects of chemical purity (Chapter 3). This situation has changed dramatically over the past decade, with an ever-increasing degree of attention being given to the physical properties of the solids that can compromise a dosage form. Ignoring the physical aspects of a formulation can be disastrous because a variety of solid-state reactions can compromise the stability of a drug entity in its tablet matrix. Often the pathway of these reactions can be dramatically different when one observes how the same reaction proceeds in the liquid or gaseous phase.

The acquisition of fairly detailed physical information can allow formulators to prepare themselves to cope with unanticipated crises. For a well-understood system, it is theoretically possible to design an automated or semiautomated manufacturing scheme for which the processing variables

can be appropriately controlled and thus the possibility of batch failure can be minimized. Materials that pass the hurdles of physical test specifications would be predictable in their performance and could therefore be blended, granulated, dried, compressed, and delivered into containers without operator intervention. It is presently recognized that to avoid problems during drug development, the physical characterization of bulk drugs, excipients, and blends of these should become part of the normal process. The degree of physical testing would necessarily vary with the particular formulation.

A systematic approach to the physical characterization of pharmaceutical solids can be outlined and serve as a useful pedagogical device for the classification of the many available methods of physical characterization. Within this system, physical properties are classified as being associated with the molecular level (associated with individual molecules), the particulate level (pertaining to individual solid particles), or the bulk level (associated with an assembly of particulate species).

C. Degradation and Impurity Analysis of Drug Substances

The United States Pharmacopoeia deals with impurities under several sections:

- Impurities in Official Articles
- Ordinary Impurities
- Organic Volatile Impurities

The following terms are used to describe impurities:

- Foreign substances
- Toxic impurities
- Concomitant components
- Signal impurities
- Ordinary impurities
- Organic volatile impurities

Impurities in a pharmaceutical compound or an NCE originate mainly during the synthesis process from raw materials, solvents, intermediates, and by-products.¹ The raw materials are generally manufactured to much lower purity requirements than a drug substance. Hence, it is easy to understand why they would contain a number of components that, in turn, could affect the purity of the drug substance. Similarly, solvents used in the synthesis are likely to contain a number of impurities that may range from trace levels to significant amounts that can react with various chemicals used in the synthesis to produce other impurities. Intermediates are also not generally held to the purity level of the drug substance—hence the remarks made for the raw materials apply. By-products are frequently unknown and are very rarely controlled. So they, too, are a source of concern in terms of monitoring impurities. The “pot reactions,” that is, when the intermediates are not isolated, are convenient, economical, and timesaving; however, they raise havoc in terms of the generation of impurities because a number of reactions can occur simultaneously.

Identification of process-related impurities and products can provide an understanding with regard to the production of impurities, and it allows studies on degradation mechanisms. If the identification process is performed at an early stage of development, there is adequate time for improvements in the drug substance process and formulation to prevent the occurrence of these impurities and degradants. Impurity and degradant structure elucidation is a collaborative effort that involves analytical chemists (which include mass spectroscopists and nuclear magnetic resonance experts), process chemists, and/or formulators. The process uses a designed approach for impurity and/or degradant identification that focuses on efficiency, so the success of data collection is maximized. There are a number of activities other than collecting experimental data, even though the experiments are central to the process. The process used for determination of residual solvents in drugs, purposeful degradation studies, isolation and identification of impurities and degradants, and insights into the effectiveness and efficiency of a team approach are described in detail in Chapter 4.

D. Preformulation Studies

The primary objective of a preformulation study is to provide data and information with regard to a drug substance and manufacturing technology prior to initiating plans for formulation development activities and product design for a drug product. Preformulation studies culminate with the preparation of a report based on these studies that assists the formulators in their development efforts. With the data and information thus provided, the finished product can be developed based on sound principles and technical practices, with due consideration of analytical profiles, chemical/physical properties, QA/QC practice, modern manufacturing procedures, stability, and biopharmaceutical properties.

The cycle of pharmaceutical development with various stages and milestones, such as discovery, IND, NDA, and market introduction, is discussed in Chapter 5. How the preformulation fits into the total development activities and how the contents of the preformulation reports need to be more comprehensive in comparison with the conventional definition in preformulation are demonstrated. Health-care and pharmaceutical products, such as prescription drugs, generic drugs, over-the-counter products, animal health products, dietary supplements (vitamins and herbal drugs), and biotechnology-derived products, are discussed in detail. Models for some of the reports are provided to assist the pharmaceutical development team to devise its own report format based on their particular needs and resources. Analytical techniques that are useful for preformulation and regulatory conformity or requirements relative to the product registration process are also enumerated.

E. Solid Oral Dosage Forms

The pharmaceutical analysis of finished solid oral dosage forms is discussed in Chapter 6 from the standpoint of what makes this type of delivery form unique and successful (i.e., the physical properties and the state of the drug substance

in the matrix). During product development, many analytical techniques can be brought to bear, providing a characterization of the product and guiding the pathway to an optimum formula. In many cases, these techniques can be used to assess the effects of processing parameters and provide a means to predict the performance and stability of the final product.

To facilitate the development of immediate-, controlled-, and extended-release products and other types of solid dosage forms, noninvasive and nondestructive in situ techniques provide insight into the physical nature and microhomogeneity of the dosage form. These techniques include light microscopy, polarized light microscopy, scanning electron microscopy, transmission microscopy, Fourier transform infrared microspectroscopy, nuclear magnetic resonance imaging, near-infrared (NIR) analysis, Raman spectroscopy, thermal techniques, mass spectrometry, and other imaging techniques. A short discussion is also provided on new high-throughput applications of methodologies. Examples include fiber-optic dissolution technology, flow injection analysis, NIR analysis, and robotics. These techniques provide data with less analyst involvement and allow a more thorough batch quality assessment.

F. Parenteral Dosage Forms

The parenteral dosage form constitutes those dosage forms that are administered to patients via injection. They can comprise a powder that is solubilized at the time of administration or a solution or other suitable injectable dosage form that can provide faster action than the solid dosage forms such as capsules and tablets. The development process for parenteral dosage forms is discussed in Chapter 7, with emphasis on the bulk drug substance, excipients, in-process analysis, and final dosage form analysis.

Chemical analysis of parenteral products is predominantly accomplished via use of high-pressure liquid chromatography (HPLC). As with other dosage forms, the methods have to be validated to assure that they are suitable for injectables. The analytical techniques that are unique to or require some modifications to be applicable to parenteral dosage products are discussed. The potential as well as actual applications of NIR spectroscopy are also discussed. The most unusual tests that have to be carried out for parenterals are the microbiological tests, which are covered by examining in depth the sterility test, bacterial endotoxin test, and particulate matter test. The microbiological discussion has been provided to lead to better understanding of microbiological testing. Cleaning validation—an increasingly critical aspect of pharmaceutical analysis—is presented in detail, with practical examples and all the necessary calculations.

G. Developing New Dosage Forms

A variety of dosage forms provide the most convenient and cost-effective ways to treat diseases. The usefulness of these forms is enhanced by the fact that taking medications is a process easily accomplished by patients, without intensive supervision from physicians and pharmacists. This relative ease of

administration has to be credited to the enormous time and efforts spent by pharmaceutical scientists to formulate and analyze the resulting products to assure the safety and quality of the medication (Chapter 8).

In addition to ensuring that the medication is efficacious and free of serious side effects, drug delivery constitutes one of the major efforts in the drug development process. Pharmaceutical scientists have to consider the best route of administration, the target site of action, and the formulation, stability, and bioavailability of the drug. The most obvious route of administration of drugs is through the oral cavity, or in some cases through the rectum into the gastrointestinal tract. Other routes of administration that patients can handle easily are the nose, skin, and eye. Drug delivery via intravenous, intramuscular, subcutaneous, and peritoneal administration requires training, supervision, and, possibly, skilled personnel.

New and promising drug-delivery systems have been created and modified to ensure that drugs are delivered to the appropriate targets of action in the body, without major complications. For example, the remote drug-delivery capsule is an interesting concept in oral drug delivery with a nondisintegrating remote control device that has a volume less than 1 ml. The device releases the drug at the intended site, which can be the stomach, early small bowel, distal small bowel, or colon. Other interesting approaches for drug delivery for treatment of gastric ulcers and Crohn's disease have been developed.

Solid tumors display a reductive environment because of hypoxia and the overproduction of bioreductive enzymes. To take advantage of the characteristics of the environment provided by solid tumors, a bioreductive, or tumor-targeted, system has been designed. Aptamers may play an important role in the treatment of patients with cancer. They are oligonucleotides that possess a high affinity for protein targets. An aptamer prepared by solid-state synthesis has been found to bind with high affinity and specificity to the target protein.

Hormones, proteins, and small peptides are not suitable for oral administration without complex modifications in the formulation. A variety of approaches for insulin delivery, as a model drug, have been attempted to improve on its bioavailability. Advances have been realized in the delivery of insulin through oral, nasal, rectal, dermatologic, and ocular routes. Proteins can also be delivered transdermally, using a lipid-based, biphasic delivery system in therapeutic quantity.

H. Compendial Testing

To assure drug quality, various countries have published texts commonly called compendia or pharmacopoeias that list official test methods as well as specifications for commonly used drug products. Three notable examples of such compendia are the United States Pharmacopoeia (USP), the European Pharmacopoeia, and the Japanese Pharmacopoeia. Compendial methods should be implemented as written except where scientifically justified changes are necessary. Although considerable efforts are ongoing to standardize pharmacopoeias, differences may exist between the USP and other pharmacopoeias. In these instances, testing should be done in accordance with the procedures

described in the pharmacopoeia that governs the country or region for which the product is intended. The USP is used as an important guide by a number of countries. It is also the most commonly used document by QC and QA departments in the United States (Chapter 9). The QA function is critical to assure that effective, safe products are released to the marketplace. The QC analytical laboratory is the final step in a long line of processes where many individuals from diverse departments take part to ensure the safety, efficacy, and quality of drug products. Producing quality products requires not only a good testing laboratory, but an organization that is empowered to identify problems and develop innovative solutions. Analytical testing is one of the more interesting ways for scientists to take part in the quality process by providing actual data on the identity, content, and purity of drug products. A variety of analytical techniques are used that range from a very simple test such as size testing to complex chromatographic separations. Prior to the ICH, each country had its own testing requirements. For example, for carbamazepine, depending upon a given pharmacopoeia, up to four tests for identification alone could be required. There are at least six different identification tests in various leading pharmacopoeias. New methods are now being developed with a great deal of consideration to worldwide harmonization. As a result, new products can be assured to have comparable quality and they can be brought to international markets faster.

I. Method Development

Numerous methods are required to characterize drug substances and drug products (Chapter 10). Specifications may include description; identification; assay (of composite sample); tests for organic synthetic process impurities, inorganic impurities, degradation products, residual solvents, and container extractables; tests of various physicochemical properties, chiral purity, water content, content uniformity, and antioxidant and antimicrobial preservative content; microbial tests; dissolution/disintegration tests; hardness/friability tests; and tests for particle size and polymorphic form. Some of these tests may be precluded, or additional tests may be added as dictated by the chemistry of the pharmaceutical or the dosage form.

Due to the variability in specific tests required to fully characterize a pharmaceutical, it is difficult to provide a comprehensive discussion to address all aspects of pharmaceutical development. However, the requisite tests can be broadly subdivided into three main categories:

- Tests concerned with solid-state characterization
- Compendial tests
- Quantitative tests to characterize drug substance and drug product composition

Characterization in the solid-state and compendial methods has been discussed already. Quantitative tests to characterize drug substance and drug product composition require that significant consideration be given to method development. Methods such as thin layer chromatography, gas chromatography, HPLC, supercritical fluid chromatography, and capillary electrophoresis

are used for pharmaceutical analysis. Detailed discussion is provided in this book on HPLC methods, a technique most commonly used for pharmaceutical analysis. As mentioned before, phase-appropriate HPLC method development must be given serious consideration during method development. Notable examples of method development for a number of drugs (small as well as large molecules) are discussed to provide the reader with the scope of method development in pharmaceutical analysis. In addition, automated methods and hyphenated methods, such as liquid chromatography–mass spectrometry (LC/MS), liquid chromatography–tandem mass spectrometry (LC/MS/MS), and liquid chromatography–nuclear magnetic resonance (LC/NMR) are also discussed.

J. Setting Specifications

Setting appropriate specifications is an important requirement in the overall goal of ensuring that safe and effective products are consistently made available to patients (Chapter 11). The development of final specifications is an evolving process based on a continuous collection of data throughout research and development, from the first drug synthesis to commercial batch manufacture. The various stages of setting specifications are as follows:

- Preclinical studies
- IND (initial studies)
- Phase II and III studies
- NDA

Specifications evolve during this process to the point at which, in a marketing approval application, a formal specification can be set that encompasses all that has been learned about the drug substance and its formulations during development.

From the regulatory perspective, ICH has created a strong process for providing valuable guidelines to aid a manufacturer to set consistent specifications that will be accepted by regulatory agencies in the three major pharmaceutical marketplaces—the United States, Europe, and Japan. ICH guidelines include:

- Scope
- General concepts
- Justification
- Universal tests and criteria
- Specific tests and criteria

Test procedures and acceptance criteria for biotechnological/biological products also have been provided, and other ICH quality guidelines relevant to setting specifications have been included. These guidelines relate to stability testing, method validation, impurities, and pharmacopoeial harmonization. Statistical considerations in specifications are also covered in some detail. In short, specifications must be set after due consideration of manufacturing variability, analytical variability, and sampling techniques. It is important to remember that specifications are just one part of an overall manufacturing philosophy that must include appropriate product design, development and

manufacturing systems and controls, and good manufacturing practices, with personnel that are experienced and well versed in good production processes and techniques.

K. Method Validation

The primary objective of method validation is to provide a high degree of assurance that the specified method consistently provides accurate test results that evaluate a product against its defined specification and quality attributes (Chapter 12). The regulations require that validation data be available to establish that the analytical procedures used in testing meet proper standards of accuracy and reliability. All analytical procedures require some form of validation, regardless of whether the method is used for stability, in-process analysis, release, or acceptance. Most of the discussions focus on the validation of HPLC methods using assay and purity determinations; nevertheless, fundamentals of the approach can be applied to most method validation activities.

Many analytical test methods are expected to ultimately be used in a QC environment; these require an additional degree of refinement compared to research methods. Methods for multilaboratory use are also required to be robust. It must be remembered that the validation process requires quality method development. Whereas validation can be a time-consuming process, methods should not enter the validation phase unless they are fully developed. The following observations can be made about the relationship of validation and method development:

- When methods are properly developed, they can be readily validated.
- Validation does not make a method better or more efficient.
- A validated method does not necessarily imply that it meets all criteria of a properly developed method.
- Validation acceptance criteria should be based on method development experience.

Method development scientists should not start the validation process unless they are confident of success. The validation process is “confirmation” that the method is suited for its intended purpose; there should be very few “surprises” in validation results, because prevalidation evaluation data should suggest that the method will validate successfully. Method validation is also a “holistic” process that requires suitable instrumentation and competence in laboratory techniques to insure success.

Although the requirements of validation have been documented clearly by regulatory authorities, the approach to validation is varied and open to interpretation. The approach listed here focuses on ICH guidelines. Also, because validation requirements differ during the development process of pharmaceuticals, the requirements for later phases in development and for methods used to evaluate marketed products cannot be overemphasized.

Prior to beginning validation, controls should exist to insure that the method has been developed properly and is capable of the objectives outlined prior to starting the method development endeavor. Validation is considered a GMP activity. Therefore, validation activities must be documented properly

and performed on qualified and calibrated instrumentation and equipment. At this stage, there should be documented evidence that the method is robust.

Validation does not necessarily certify a method as “good,” robust, or suitable for a control environment; these assessments must be established in the method during development. It is, however, a necessary and important step in both proving and documenting the capabilities of the method.

Governmental agencies require accurate information and data recorded both in regulatory filings and in day-to-day operations of pharmaceutical manufacture. From a pharmaceutical laboratory perspective, analysts need to insure the accuracy and reliability of the data generated by their test methods.

L. Stability Studies

It is necessary to conduct stability studies to predict, evaluate, and ensure drug product safety.⁴ The legal requirements of stability are aimed at ensuring that the drug product remains within the specifications established to ensure its identity, strength, quality, and purity. Stability is interpreted as the length of time under specific conditions and storage that a product will remain within the predefined limits for all of its important characteristics. It is important to remember that stability is fundamental to all of the product's characteristics, including safety and efficacy.

Operating a dynamic, compliant stability program requires more than just knowing and adhering to the various regulatory requirements (Chapter 13). It also requires management of the stability samples, the environmental chambers, and all of the associated documentation. Standard operating procedures and processes for protocol deviations and for out-of-specification investigations are also key elements of a compliant stability program.

Test attributes; procedures and acceptance criteria; selection of batches; testing frequency; storage containers, conditions, and period, as well as data evaluation are discussed in great detail. Data evaluation considers out-of-specification results. Documentation covers protocols and protocol amendments, deviation reports, out-of-specification reports, test results and raw data, and stability reports.

In short, it is important to manage both the operational elements and the regulatory compliance issues to insure a successful inspection by any regulatory agency. The FDA, World Health Organization, and ICH guidelines related to stability are discussed in detail.

M. Analytical Methodology Transfer

The transfer of analytical methodology allows for a successful transfer of technology development for a new drug product. As mentioned previously, it is a very important document, even though on the surface it may appear to be a relatively simple operation (Chapter 14). The important elements of analytical technology transfer are the following:

- Preapproved test plan/SOP/protocol
- Description of methods/test procedures

- Description of test requirements
- Rationale for test requirements
- Acceptance criteria
- Documentation of results

The importance of analytical transfer was recently underscored by the Analytical Research and Development Steering Committee of the Pharmaceutical Research and Manufacturers Association (PhRMA) at their annual workshop. At this meeting, representatives from PhRMA member companies met with facilitators to draft an “acceptable analytical practice” (AAP) that will function as a suitable template for successful method transfer. Both facets of technology transfer have been discussed in this book.

Analytical method transfer verifies that a method or test procedure works in an equivalent fashion at two or more different sites or laboratories and meets all acceptance criteria. This process is driven by compliance and governed by a statistical treatment of the resulting data. Method transfer entails introduction of a validated method into a designated laboratory so that it can be used as it was originally intended. The second portion of the technology transfer process concerns the transfer of technical “ownership” from one laboratory to another. This latter type of transfer is usually associated with the movement of drug development projects from R&D to operations. In many case studies that involve technical transfer, the process of ensuring that the receiving laboratory is sufficiently familiar with all scientific aspects of the project is not carried through to fruition. Indeed, rapid and complete transfers are crucial to the success of process validation experiments for pharmaceutical dosage forms.

Pharmaceutical analysts working in R&D develop and refine the methods that eventually will be utilized to test the identity, quality, purity, potency, and composition of marketed products. It is not unusual for analytical methods to undergo multiple iterations during the development life cycle of a pharmaceutical product. Method alterations are the result of changes to any number of product parameters, including, but not limited to, API synthesis, formulation composition, and dosage form manufacturing processes. Although it is important to keep the needs of the QA unit in mind when refining the methods for which they eventually will have technical ownership, a great many QA units do not become intimately involved with such changes. At the conclusion of development, when methods become “locked,” it is becoming more common to ask the QA unit for input and comment on the proposed method package prior to final validation. Such a method “test-drive” can avoid problems with the formal transfer that takes place later. This process allows the QA unit to make comments and suggestions to their R&D colleagues prior to the final validation of the method. In this fashion, the frequent “throw the method over the fence” syndrome is avoided.

Assuming the clinical development plan proceeds smoothly, the formal transfer of analytical methods takes place during the latter part of clinical phase III. At this point, the requirements for analytical technical transfer are outlined between R&D and operations, and are suitably executed. After successfully meeting appropriate acceptance criteria, the receiving laboratory is

now considered to be “qualified” and able to generate “reportable” data as defined by cGMPs. In most companies, further transfers that take place after the approval of a product are driven and administered by the QA unit. Such transfers might include those to a contract research organization or multiple manufacturing and testing sites. Due to time constraints, an R&D organization may sometimes transfer to multiple sites simultaneously.

N. Documentation and Inspection

Pharmaceutical analytical documentation must accomplish the key mission of analytical research and development (Chapter 15): monitor and ensure the identity, purity, stability, and consistency of drug substances and dosage forms used during preclinical, clinical, and marketing phases in accord with governing regulatory guidance and policies. Analytical data are the foundation and backbone for pharmaceutical development, leading to approval and production of new drugs for market. Analytical documentation provides critical links during the evolution and life cycle of a new pharmaceutical product—beginning from earliest studies, enabling entry into humans, through product launch and postapproval changes. Prior to marketing approval, analytical R&D personnel support product development and optimization activities. Following approval, QC personnel provide the data to assure consistent quality and stability for the marketed product and to support the inevitable changes that occur in every product’s life cycle. Scientifically sound and compliant documents ensure the quality and timeliness of product development and the continued quality of the marketed product.

Analytical documentation requirements during the life cycle of a pharmaceutical product—from initial candidate screening and selection, through entry into humans/IND, to NDA and postapproval marketed product support—are discussed in this book. Most of the information is based on US FDA and ICH guidelines; EU requirements are not substantially different.

O. Innovative Analytical Platforms

Numerous published papers illustrate the role of new analytical platforms based on combinations of two or more techniques (they are frequently called hyphenated methods), such as LC/MS, LC/MS/MS, and LC/NMR. Of these platforms, LC/NMR is gaining increasing importance in modern pharmaceutical analysis. All these hyphenated methods are covered in this book (see Chapter 10).

A short discussion of new high-throughput applications of methodologies for solid dosage forms is presented in Chapter 6. Examples include fiber-optic dissolution technology, flow injection analysis, NIR analysis, and robotics. These techniques provide data with less analyst involvement and allow a more thorough batch quality assessment.

Both chemistry and biology have converged on a common 96-well format as a convenient means of combinatorial synthesis, purification, compound storage, and drug screening. The development of assay plates with the same footprint but increasingly high density arrays (e.g., 384, 864, and 1536) has

led to benefits in reduction of compounds and reagents required for assay and in time taken to run the screen. Assay formats such as 1536 can be used to screen 16 times the number of samples a standard 96-well format can assay. A number of logistics problems have yet to be solved to make this technique suitable for everyday use (see Chapter 2).

The development of miniaturized chemical analysis systems has received considerable attention. The lab-on-a-chip concept promises to revolutionize the area of HTS.⁵ Miniaturization is very desirable in separation science because it helps work with smaller sample sizes, while gaining high speed and high-throughput separations without compromising resolution and detection sensitivity. Furthermore, it can help reduce the consumption of various reagents and organic solvents, thus being environment friendly and helping to control the cost of disposal. In the past decade, miniaturization of capillary electrophoresis systems in the form of microfabricated electrophoretic devices has achieved great success in comparison with other miniaturized separation techniques. Analyses of a wide variety of molecules have been demonstrated with this new and innovative technology. Chapter 16 reviews the current state-of-the-art design and fabrication aspects of microfabricated electrophoresis devices, as well as development of popular detection modes applicable to chip devices. Potential areas in pharmaceutical analysis are highlighted based on the successful demonstration made with analysis of phase I proteins, peptides, DNA, other small molecules, and chiral separations.

In the future, nanotechnology is likely to benefit many areas of medicine such as sensors for use in the laboratory or clinic and within the human body, new drug formulations, and novel drug-delivery systems. The most important potential uses of nanotechnology in medicine include the early detection and treatment of disease.

REFERENCES

1. Ahuja, S. *Impurities Evaluation of Pharmaceuticals*, Dekker, New York, 1998.
2. Ahuja, S. *Chiral Separations by Chromatography*, Oxford Univ. Press, New York, 2000.
3. *AAPS Workshop on Designing the Global Chemistry, Manufacturing, and Control*, Bethesda, MD, 1995.
4. Mollica, J. A., Ahuja, S., and Cohen, J. J. *Pharm. Sci.* 67:443, 1978.
5. Ahuja, S. *Handbook of Bioseparations*, Academic Press, New York, 2000.

2

COMBINATORIAL CHEMISTRY AND HIGH-THROUGHPUT SCREENING IN DRUG DISCOVERY AND DEVELOPMENT

KEN APPELL

JOHN J. BALDWIN

WILLIAM J. EGAN

Pharmacopoeia, Inc., Princeton, New Jersey 08543-5350

- I. INTRODUCTION
- II. COMBINATORIAL METHODS
 - A. Solution-Phase Libraries
 - B. Solid-Phase Libraries
 - C. Split Synthesis
- III. METHODS FOR STRUCTURAL ASSIGNMENT
 - A. Encoding
- IV. DIVERSITY
- V. DRUGLIKENESS
- VI. DESIGNING COMBINATORIAL LIBRARIES WITH OPTIMAL ADME PROPERTIES
- VII. EXISTING COMPUTATIONAL METHODS FOR ADME PROPERTIES
 - A. Druglikeness
 - B. Absorption
 - C. Distribution
 - D. Metabolism
 - E. Excretion
- VIII. OPTIMIZATION PHILOSOPHY
- IX. APPLYING EXISTING ADME MODELS TO COMBINATORIAL LIBRARY DESIGN
- X. THE FUTURE OF ADME MODELING
- XI. HIGH-THROUGHPUT SCREENING AND COMBINATORIAL CHEMISTRY
- XII. ASSAY PLATE FORMATS: MOVE TO MINIATURIZATION
 - A. 1536-Well Technologies
 - B. Summary
- XIII. NONSEPARATION OR HOMOGENEOUS ASSAYS

- XIV. IDENTIFICATION OF RECEPTOR ANTAGONISTS FOR CHEMOKINE RECEPTOR AND BRADYKININ-1 BY SCREENING A 150,000-MEMBER COMBINATORIAL LIBRARY
- XV. STRUCTURE-BASED DESIGN OF SOMATOSTATIN AGONISTS
- XVI. CONCLUSIONS
REFERENCES

I. INTRODUCTION

Combinatorial chemistry is a synthesis strategy that enables the simultaneous production of large numbers of related compounds. These sets are referred to as libraries and they can be used in any discovery project associated with high-throughput analysis capabilities. The most common application is in drug discovery, but combinatorial methods also have been used, if less frequently, in the materials science area as well.

Combinatorial chemistry coupled to high-throughput screening (HTS) and computational methods has been integrated into the lead discovery and optimization process throughout the pharmaceutical industry. As this integration has proceeded, the emphasis, based on publications, has shifted from its use in lead discovery toward targeted and optimization libraries, that is, toward those libraries that contain a structural bias for a particular biological target or for improving the potency or physical properties of the screening hit. Publications indicate that the percentage of discovery libraries has decreased by approximately two-thirds, going from 57% in the 1992–1997 time frame to 21% in 1999. During this period the percentage of targeted and optimization libraries has doubled to 59 and 25%, respectively.¹ With the proliferation of new targets expected from genomics research, all three types of combinatorial libraries have become increasingly important, not only for the discovery of compounds that interact with novel macromolecular targets, but also for their acceleration toward drug candidates.

Even with these technologies, bringing a new drug to market remains an enormous task. Today only 10% of compounds that enter the development cycle reach the pharmacy shelf.^{2–4} Many of the failures are due to poor pharmacokinetic properties that are recognized only late in the cycle, and these “mistakes” possibly could have been avoided by early culling of poor leads. With a success rate of only 0.8 new drugs per company per year, finding and focusing on better quality leads with improved likelihood of survival becomes essential and it is here that the improved design of combinatorial libraries coupled to HTS can have an enormous positive impact. These points are expanded upon later in this chapter.

The origins of combinatorial chemistry can be traced back to solid phase peptide synthesis in the 1960s, but as applied to small druglike molecules, the technology started to become widely applied during the latter part of the 1990s. The use of combinatorial chemistry in drug discovery ushered in a new chapter in chemical synthesis within the pharmaceutical laboratory. For the

first time, small druglike compounds could be made in large numbers by parallel methods rather than by classical individualized serial synthesis.

The general synthetic strategy used for combinatorial chemistry is similar to the more classical approach, that is, commercial synthons or building blocks are combined through a range of usually established methods to generate a new entity. The combinatorial approach differs in that the reactions are generalized for a range of building blocks, so that a related set of compounds are simultaneously produced.

II. COMBINATORIAL METHODS

Small-molecule libraries may be created by a variety of methods. These include traditional solution chemistry performed in parallel using multiple reaction vessels so that the individualized chemistry performed in each vessel is, in effect, spatially encoded and hence the structure of the product is implicit by vessel.^{5,6} Alternatively, the chemistry can be performed on a solid support, usually polystyrene beads, in individual vessels, or the supports can be combined into pools where each bead is viewed as a separate reaction vessel. This allows a whole range of design strategies to be employed (*vide supra*). According to a recent literature survey, two-thirds of reported libraries are prepared on solid support and one-third by solution chemistry.⁵

A. Solution-Phase Libraries

Ideal reactions for solution-phase parallel synthesis are those that are kinetically and thermodynamically favored, are tolerant of diverse functionality, and have a broad range of reactant tolerance. In this approach, capture resins and extraction procedures are often used for preliminary purification.⁶ The solution-phase reaction conditions must be validated in terms of scope and optimal reaction conditions over the range of reactants. Two common strategies for solution libraries involve derivatization of preformed functionalized scaffolds and multicomponent condensation reactions,⁷ for example, the Ugi reaction, the Passerini reaction, and the formation of hydroxyaminimides from an ester, a hydrazine, and an epoxide.

B. Solid-Phase Libraries

Solid-phase parallel synthesis mimics the previously described solution phase strategy.⁸⁻¹⁴ This approach easily lends itself to both semi- and full automation. In contrast to the solution phase method, purification is easily achieved by simply washing the resin beads, and the reactions can be driven to completion by excess reagents, multiple cycles, and microwave techniques. The initial building block or scaffold is attached to the resin bead by a detachable linker. At the end of the synthesis, the final construct is released under the appropriate cleavage conditions for automated purification, usually by high-pressure liquid chromatography (HPLC). This allows bioanalysis of the final product in aqueous solution under standard assay conditions.

C. Split Synthesis

Today's parallel methods remain limited in terms of their ability to produce the large numbers of compounds that many believe will be required by the large number of novel targets predicted to evolve from the Human Genome Project. These novel bioassays coupled with HTS will place an enormous burden on compound production and informatics capabilities. The techniques prepared to handle this need are the "split synthesis" and the "direct divide" solid phase synthesis methods. These methods involve the division and pooling of resin particles such that large libraries can be easily produced, usually with a minimum investment in automation.

Split synthesis or "one bead one compound" was first described by Furka *et al.*^{15, 16} and later by Lam *et al.*¹⁷ The method involves reacting each of the first step synthons with solid support beads separated into pools. After the reaction is judged to be complete, the pools are combined and then redivided into separate second stage reaction vessels. The second set of synthons is then added individually to the newly divided resin pools. This process is continued until the synthesis is complete. The number of library members produced is a multiple of the number of synthons used at each combinatorial step, for example, if 10 synthons are used in each of three synthetic steps, the number of compounds simultaneously produced will be 1000.

The direct divide method¹⁸ is similar except no pooling step is involved. Instead, the solid support particles from each reaction vessel are separately divided into the next reaction set of vessels to form new pools. This approach was introduced to better control the distribution of resin beads, thereby achieving a more equal number of each member in the final library.

III. METHODS FOR STRUCTURAL ASSIGNMENT

A process called deconvolution is commonly employed to determine biological activity.¹⁹ The final library pools are not combined but are tested as either "on-bead" or "detached" compound mixtures. The most active pool defines which synthon is preferred in the last step. The synthesis is repeated to the penultimate set of pools and these are then allowed to react with the "best" last step synthon. Alternatively, pools of conserved resin from the penultimate step held back during the original synthesis may be used. The most active pool found on retesting defines the best last two synthons. This process is repeated until the most active member is identified. A somewhat similar method termed position scanning also has found successful application, especially in the analysis of peptides.²⁰

A. Encoding

Encoding techniques provide an alternative to deconvolution. In this method, a unique tag molecule or set of tags is introduced at each synthetic step to define each synthon used during library construction. This approach accurately records in the "tag bar code" those synthetic steps and exact synthons that any

particular library bead has seen; the tag set then implies the structure of the compound through the reaction history of the bead.

Because the amount of compound releasable from a single synthesis bead (e.g., the 180- μm Tentagel[®] bead) is in the range of 0.5–1 pmol, material available after biotesting is insufficient for traditional physical and spectroscopic characterization. Therefore, the implied structure available from the encoding process not only avoids deconvolution, but defines the structure that can be confirmed by classical methods after resynthesis. In our experience, the code correctly defines the assigned structure based on resynthesized samples in 97% of the cases examined. The ease of structural assignment through encoding allows all active compounds to be defined, thereby providing a level of structure–activity relationships (SAR) even at the level of primary screening. Although a number of approaches to encoding have been described, the five principal types are DNA strands, peptide strands, molecular tags, radiofrequency (RF) transponders, and alphanumeric labeling.

The DNA strands were first reported by Brenner and co-workers^{21, 22} to define the sequence of a peptide constructed on a solid support. Upon completion of the synthesis, an on-bead assay was performed. Whereas each bioactive peptide was defined by a unique DNA sequence, the decoding process simply involved amplification of the code by the polymerase chain reaction followed by sequencing. This technique marked the beginning of the tagging method for encoded split synthesis. Sequenceable peptide strands are an alternative to DNA encoding.²³ The code is read by HPLC of the Edman degradation phenylthiohydantoin amino acid derivatives, a well-developed microsequencing method.

The next major advance in encoding came with the development of molecular tags.¹⁹ The encoding molecules were designed to avoid the chemical sensitivity and detection limitations of the DNA and peptide strands. The two most used types of chemically robust tags are the electrophoric halophenoxyalkylethers and the fluorescent dialkylsulfonamides. The electrophoric tags are used primarily by us and the fluorescent dansyl derivatives are used by Glaxo-Wellcome/Affymax. The compound constructed on the solid support is detachable by a linker utilizing chemistry different from that required for removal of the encoding molecules.

The RF tags are transponders usually used by placing a glass-encapsulated microchip into a mesh capsule loaded with resin beads. The chip can either emit a binary code that is scanned at each synthetic step or receive and record binary information sent by a transmitter each time chemistry is performed.^{23–25} This method does not require the introduction of tag molecules and, therefore, does not need an orthogonal linking strategy. Other nonchemical methods similar to RF tagging that have been developed include alphanumeric labeling^{26–28} and laser optical encoding. Because the tagged particle is so much larger than the split synthesis bead, there is an inherent limitation on the library size. Therefore, these approaches are usually used in the hit-to-lead phase, where individual compounds are evaluated in a comparative way. In contrast to large encoded particles, the encoded split synthesis libraries are extremely useful in lead discovery and in the rapid generation of SAR information.

IV. DIVERSITY

It is with “prospecting” libraries that compound diversity is often viewed as a central issue. To achieve broad structural diversity, it is desirable for the synthetic strategy to allow for the introduction of multiple scaffolds and the selection and regiosubstitution of substituents. Such variation with an eye toward overall two- (2D) and three-dimensional (3D) diversity results in a whole range of approaches and methods for selecting diverse substituents and measuring the resulting molecular differences. Calculations based on 2D fingerprints,^{29, 30} 3D descriptors,^{30, 31} and 3D lattice analysis³² are commonly employed.

V. DRUGLIKENESS

The focus on issues that surround the practice of combinatorial chemistry has shifted from the development of solid-phase chemical conversions, the relevance of library size, and the meaning of diversity in design to the incorporation of druglike characteristics into the library members. As the ability to generate a broad variety of structural types has expanded, the need to look downstream toward the questions of bioavailability and toxicity has become critically important. Control of the physicochemical properties present in the library members during the virtual library design and culling process has been made possible by rapid analysis and visualization tools. High percentages of compounds in any given library can be placed in the druglike range with some level of confidence. The intuitive guidelines of the medicinal chemists have been codified into a set of guidelines called the rule of 5, which limits the molecular weight, $\log P$, and number of hydrogen bond donors and acceptors.³³

A second approach to a higher quality library emphasizes a leadlike rather than a druglike collection. Such a library contains members in the molecular weight range of 100–350 and a calculated $\log P$ of 1–3. It has been suggested that compounds from such libraries with IC_{50} s in the 1–10- μ M range can be more easily optimized to drug candidates than compounds with higher molecular weight and $c \log Ps$.³⁴

This trend toward library design that emphasizes optimizable druglike leads may decrease the probability for later failure (see Section VII). Continued emphasis on the development of *in silico* approaches for critical parameters in addition to passive absorption will have a positive impact on increasing the survival rate as candidates move through the development cycle.

VI. DESIGNING COMBINATORIAL LIBRARIES WITH OPTIMAL ADME PROPERTIES

Combinatorial chemistry has produced libraries that total millions of compounds; for example, our collection contained 7.17 million compounds as of May 31, 2000. HTS of these large compound collections allows the rapid search of a much larger region of chemical space for structure–activity relationships than could be searched previously. However, high activity is only

The “Ideal” Drug

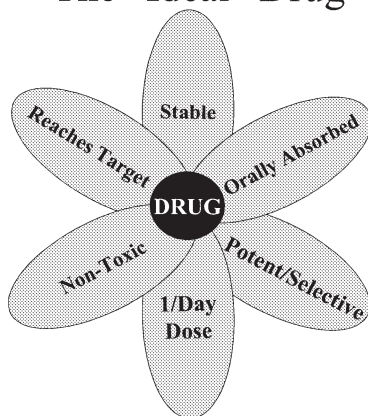

FIGURE 1 The desirable traits a molecule should possess to be considered a drug.

one requirement for a drug; one estimate found efficacy by itself to account for only 29% of failures in clinical trials.³⁵ An ideal drug (Fig. 1) should be orally well absorbed, sufficiently metabolically stable to induce the desired pharmacologic effect, nontoxic, cause minimal or no adverse effects, distribute selectively to the target tissue(s), and have a reasonably long half-life.

Unfortunately, the pharmaceutical industry has had considerable difficulty finding compounds that possess all of these desirable traits. Drug discovery and development is currently a process of managing failures and their costs. Ninety percent of compounds that have an investigational new drug (IND) filing fail before achieving an approved new drug application (NDA).³⁶ The cost of developing a new drug is estimated at \$350–500 million and over 85% of this cost is due to the expense of clinical testing, which means that these failures represent the majority of the cost incurred in drug discovery and development.³⁷ The role that absorption, distribution, metabolism, and excretion (ADME) play in causing these failures is significant, and a survey by Prentis *et al.*³⁵ estimated that approximately 50% of failures in clinical trials are due to ADME problems. Clearly, the benefits of enhancing the ADME properties of molecules through computational design in the discovery phase are enormous and, recently, much attention has been devoted to this issue in the literature.^{38–45}

The success rate of compounds that pass from the discovery phase to an approved NDA is approximately 1%. Therefore, it is useful to group the properties of a drug into categories, based on whether a property is a major cause of failures and should be considered by itself or is usually a minor concern and can be grouped with other properties with similar influence. Such an analysis establishes five categories: activity, absorption, metabolism, toxicity, and a group of properties that comprise distribution, excretion, and selectivity. These categories are obviously quite simplistic, but they do permit an estimation of the implied success rate of compounds for each category when each property category is considered independently. As Figure 2 shows, there is a 40% implied success rate (the fifth root of 1%) for each property category, given the

A “Back-of-the-Envelope” View of Success

Activity	Abs.	Metab.	Tox.	Distribution Excretion Selectivity	New Drug Success Rate					
<i>1% success rate discovery ⇒ NDA</i>										
40%	×	40%	×	40%	×	40%	×	40%	=	1%
										to increase 2×
46%	×	46%	×	46%	×	46%	×	46%	=	2%
<i>10% success rate preclinical ⇒ NDA</i>										
63%	×	63%	×	63%	×	63%	×	63%	=	10%
										to increase 2×
72%	×	72%	×	72%	×	72%	×	72%	=	20%

(Simple estimate of implied step-wise success rate)

FIGURE 2 The required improvements for each desired property for drug discovery and development success rates, assuming that the given property categories and the success rates of those categories are independent of one another.

assumed 1% success rate for compounds going from discovery to NDA. To double the overall success rate to 2% for compounds going from the discovery phase to NDA, a company must have a 46% success rate for compounds in each property category. Thus, only a small incremental improvement is necessary in each of a set of property categories, which are mostly ADME-related, to double the final number of drugs brought to market from the discovery phase.

Similarly, the commonly used success rate for compounds going from pre-clinical studies to NDA is approximately 10%, and Figure 2 shows that the implied success rate over those stages is 63%. To double the overall success rate to 20% for compounds going from the preclinical studies to NDA, a company must have a 72% success rate for compounds in each property category. Although different and more complicated groupings of properties certainly can be made, allowing more accurate estimates of probabilities, such analysis would require detailed historical knowledge of a large pharmaceutical company's development efforts. Although such data are not publicly available, the generally agreed upon success rates for the entire pharmaceutical industry leads to the conclusion that mere incremental improvements in the numbers of compounds that have acceptable ADME properties could increase the number of drugs brought to market substantially. These figures may be nothing more than a thought experiment, but the result is provocative.

VII. EXISTING COMPUTATIONAL METHODS FOR ADME PROPERTIES

Current models for ADME actually fall into two categories: (1) models that predict the general druglikeness of a molecule, using existing drugs, drug-like molecules, and nondruglike molecules, and (2) models that are designed to predict a specific ADME property, for example, passive intestinal absorption or potential for metabolism by CYP450-2D6. Existing ADME models are structure/fragment based, physicochemical property-based, or incorporate a mixture of both structural/fragment and physicochemical descriptors.

A. Druglikeness

A variety of models have been developed to predict the druglikeness of a molecule.^{42, 46, 48} In an early study, fuzzy adaptive least squares (FALS) was used to classify 188 drugs by their bioavailability for three chemical classes—aromatics, nonaromatics, and heteroaromatics—based upon structural and physicochemical descriptors.⁴⁷ Extensive work has been performed to examine known druglike and nondruglike molecules to assess what structural motifs are associated with druglike molecules. Bemis and Murcko^{48, 49} analyzed the core structures and side chains of molecules in the Comprehensive Medicinal Chemistry Database (CMC) and found that just 32 frameworks account for 50% of 5120 druglike molecules and that 73% of the 15,000 side chain occurrences in the CMC data set were from the “top 20” side chains. A retrosynthetic combinatorial analysis procedure (RECAP) was used to analyze the Derwent World Drug Index (WDI) to identify common substructures in biologically active molecules based upon fragmentation of bonds formed in common chemical reactions.⁵⁰ In a related article,⁵¹ all possible local structures for n -centered groups (where $n = 1-4$) were computed for the CMC and MDDR databases. The authors concluded that good discrimination between known drugs and compounds with poor drug properties was possible and that the method likely covered 74–89% of drug chemical space. A decision tree method was able to correctly classify 92% of druglike and 66% of nondruglike molecules using the $A \log P$ atom types combined with other simple fragment descriptors.⁵² Neural networks also have been successfully applied to the prediction of druglikeness with correct classification rates of approximately 80%, using $A \log P$ atom types⁵³ and ISIS fingerprint keys combined with physicochemical descriptors.⁵⁴

Less complex assessments of druglikeness also have been developed. Perhaps the best known is Lipinski's rule of 5 method,³⁴ which is based on an analysis of 2287 compounds with USAN/INN designations. These designations are typically applied for prior to entry into phase II clinical trials; thus these compounds satisfactorily completed phase I clinical trials, which include assessments of ADME/toxicity properties. In this model, compounds are considered less likely to be permeable/soluble if their $C \log P > 5$, molecular weight (MW) > 500 , or they possess more than 5 H-bond donors or more than 10 H-bond acceptors. Ghose *et al.*⁵⁵ performed a similar analysis on the 6454 compounds that are druglike by therapeutic class in the CMC database. They computed 80th percentile ranges for $A \log P$ (-0.4 to 5.6), MW ($160-480$), molar refractivity ($40-130$), and number of atoms ($20-70$). Oprea⁵⁶ analyzed the distributions of properties for a variety of druglike and nondruglike data sets, using the previously listed descriptors, as well as the number of rings and rigid bonds.

B. Absorption

The process of intestinal absorption has three components: (1) passive diffusion across the membrane, (2) active transport into the membrane, and (3) active efflux out of the membrane. Lipophilicity, hydrophilicity, size, and

degree of ionization are generally regarded as the most crucial properties that affect the passive intestinal absorption of a molecule.^{38, 39, 57–60} Models for passive intestinal absorption that are of particular interest are Lipinski's rule of 5 (discussed already),³⁴ the polar surface area (PSA) models,^{61–63} and the molecular weight/ $\log P$ model of Camenisch *et al.*^{64, 65} Dynamic PSA, which is computed as the Boltzmann averaged van der Waals surface area of nitrogen and oxygen atoms and any hydrogen atoms attached to those atoms for a set of low energy conformers, is used to estimate the hydrogen bonding ability of a molecule. Excessive hydrogen bonding is known to lower the membrane permeability of a molecule^{66, 67} and intestinal absorption has been shown to decrease sigmoidally with increasing PSA.⁶¹ Clark⁶² demonstrated that the Boltzmann averaging used to compute dynamic PSA is superfluous and that an almost identical relationship with intestinal absorption exists with PSA computed from a single conformer. Camenisch *et al.*^{64, 65} developed a model that predicts Caco-2 cell permeability to decrease sigmoidally as $\log D$ decreases, with the curvature of the sigmoid being dependent upon molecular weight. A variety of more complex models have been developed to predict human absorption and/or Caco-2 cell permeability.^{68–72}

Active transport mechanisms for the intestinal absorption of amino acids, oligopeptides, monosaccharides, monocarboxylic acids, phosphate, bile acids, and a number of vitamins have been identified and the review by Tsuji and Tamai⁷³ provides an excellent summary of those mechanisms. The potential use of intestinal peptide⁷⁴ and hepatic bile acid carriers⁷⁵ to enhance drug absorption also has been reviewed. Structural and molecular modeling studies have postulated molecular structural features necessary for substrate recognition by the intestinal peptide carrier^{76, 77} and the bile acid carrier.⁷⁸

Active mechanisms for the secretory efflux of drugs,⁷⁹ mainly via the *p*-glycoprotein (pGp) efflux pump, lower oral absorption and form the basis for multidrug resistance in chemotherapy. Seelig⁸⁰ proposed a pattern of substrate features for recognition by pGp, based on the spatial separation of two or three electron donor groups. Doepenschmitt *et al.*⁸¹ suggested that the reduction of intestinal permeability caused by pGp may be greatest for those compounds that are less passively permeable, even if they do not have a high affinity for pGp.

C. Distribution

Achieving penetration of the blood–brain barrier (BBB) is a crucial requirement for certain classes of drugs. Several reviews have appeared on the problem of predicting BBB penetration.^{82–84} Models similar to those employed in the prediction of intestinal absorption have been developed for rat brain capillary penetration.⁸⁵ Young *et al.*⁸⁶ found a good correlation between $\Delta \log P$ [the difference between $\log P(\text{octanol/water})$ and $\log P(\text{cyclohexane/water})$] and brain penetration, implying that high hydrogen bonding capability was a factor in poor BBB passage. The hydrophilic portion of the van der Waal's surface area was subsequently shown to correlate with \log_{10} of the ratio of concentration in the brain to the concentration in blood).⁸⁷ A more

complex model that included descriptors for excess molar refraction, dipolarity/polarizability, hydrogen bond acidity/basicity, and solute size predicted log BB well⁸⁸ and was later shown to give better predictions for log BB than a model based on log *P* and H-bonding terms.⁸⁹ Solvation free energy in water also has been used to predict log BB.⁹⁰ Partial-least-squares (PLS) modeling predicted log BB with $R^2 = 0.862$ and root mean squared error (RMSE) = 0.288 using H bonding, acidity/basicity, surface area, and polarizability descriptors.⁹¹ Luco⁹² performed a similar analysis, but used topological as well as hydrogen bonding descriptors, constructing a PLS model with $r^2 = 0.85$. PSA, a measurement essentially the same as the hydrophilic portion of the van der Waal's surface area used by van de Waterbeemd and Kansy,⁸⁷ was combined with $c \log P$ to give a PLS model with $R^2 = 0.787$.⁹³ Examination of the single conformer PSA of 776 orally administered central nervous system (CNS) drugs found that practically all of those drugs had a $PSA < 90 \text{ \AA}^2$.⁹⁴

Drug protein binding (PB) to plasma proteins, primarily human serum albumin and α_1 -acid glycoprotein, affects both the apparent volume of distribution (V_d) and the type of clearance, both of which in turn determine the half-life of a drug.^{95,96} A recent experiment demonstrated that protein binding lowers the BBB penetration of glycine/NMDA (N-methyl-D-aspartic acid) receptor antagonists.⁹⁷ Early work by Moriguchi⁹⁸ found a linear relationship between pK_a and the protein binding of aromatic carboxylic acids to bovine serum albumin. Biagi *et al.*⁹⁹ showed that lipophilicity as measured by chromatographic R_m values was correlated with protein binding ($r = 0.918$). Structure-activity relationships involving lipophilicity and charge effects on PB have been reviewed.¹⁰⁰ Seydel and Schaper¹⁰¹ reviewed quantitative SARs and pharmacokinetics, and discussed models that predict PB using lipophilicity and hydrophilic interactions. Ritschel and Hammer¹⁰² used *in vitro* methods to predict V_d using the extent of PB and partition coefficients. A sigmoidal relationship between lipophilicity and PB was shown in a series of barbiturates tested in rats.¹⁰³ Molecular connectivity indices were used to model V_d for a set of 14 hypoglycemic drugs with good results ($r = 0.9812$).¹⁰⁴ Linear and quadratic models were used to predict 15 different pharmacokinetic properties for 17 noncongeneric drugs using physicochemical properties and other known pharmacokinetic values.¹⁰⁵ FALS has been used to classify 373 drugs by their V_d and gave r values for leave-one-out cross-validation in the range of 0.81–0.82 for three chemical classes: aromatics, nonaromatics, and heteroaromatics.¹⁰⁶ For the same three groupings of drugs, PB was classified using FALS, with prediction r values in the range of 0.723–0.825.¹⁰⁷ A second example of a sigmoidal relationship between lipophilicity and PB was shown by Lázníček and Lázníčková.¹⁰⁸ Smith¹⁰⁹ showed the combined effect of the acid/neutral/basic character of drugs and lipophilicity on free volume of distribution.

D. Metabolism

The importance of various cytochrome P450 isoenzymes in drug metabolism^{110–112} and homology modeling of their structures has been reviewed.¹¹³ The two most important CYP450 isozymes are CYP3A4 and CYP2D6, and we now review some of the more significant and recent work in pharmacophore modeling of these CYP450 isozymes.

Strobl *et al.*¹¹⁴ developed a reasonable pharmacophore model for competitive inhibitors of CYP2D6. The four pharmacophore features were (1) a positively charged nitrogen atom, (2) a flat hydrophobic region, (3) a hydrogen bond acceptor, and (4) a negative molecular electrostatic potential. A Catalyst model of 31 CYP2D6 inhibitors produced an excellent pharmacophore model ($R = 0.91$) that contained three hydrophobes, one hydrogen bond donor, and one hydrogen bond acceptor.¹¹⁵ A combined protein and pharmacophore model¹¹⁶ was developed that uses a single orientation of each molecule, maps those conformations into a pharmacophore model, and orients them into a protein model. This model, which was extended to account for N-dealkylation reactions, as well as hydroxylation and O-demethylation reactions, contains 72 metabolic pathways for 51 CYP2D6 substrates, and is reasonably predictive.¹¹⁷

MSI's Catalyst program was used to create pharmacophore models of CYP3A4 inhibitors, producing models comparable in quality to *in vitro* method predictions, which agreed well with other proposed structural feature requirements for CYP3A4.¹¹⁸ The common model included three hydrophobes and one hydrogen bond acceptor. Further work using Catalyst modeling of 38 CYP3A4 substrates produced a four point pharmacophore (two hydrogen bond acceptors 7.7 Å apart, one hydrogen bond donor, and one hydrophobic region) with good predictive ability on 12 test compounds.¹¹⁹ This work also generated a different pharmacophore hypothesis for compounds that autoactivate their own CYP3A4 metabolism; the pharmacophore had three hydrophobic regions and a hydrogen bond acceptor, but was derived from only three molecules.

Other cytochrome P450 enzymes have been studied using molecular modeling. A three feature pharmacophore model was developed for 44 quinolone compounds, which are weak competitive inhibitors of CYP1A2.¹²⁰ The Catalyst program was used to generate a reasonably predictive pharmacophore model of 16 CYP2B6 substrates.¹²¹ Comparative molecular field analysis (CoMFA) models have been successfully generated for CYP2C9.^{122, 123}

Models of phase II metabolism also have been developed. The glucuronidation rates of phenol analogue, benzoic acids, primary and secondary aliphatic alcohols, and a collection of miscellaneous compounds was modeled using linear regression based on $\log P$, molar refractivity (MR), and pK_a .¹²⁴ A generally parabolic dependence on $\log P$ was found, with the maximum rate of glucuronidation occurring at a $\log P$ of ~ 2.1 for most of the data sets; pK_a and MR were also statistically significant parameters in several of the regression equations. Holmes *et al.*¹²⁵ predicted the urinary sulfate and glucuronide conjugation of substituted phenols using physicochemical descriptors. Similar work predicted the urinary excretion and glucuronide conjugation of substituted benzoic acids in rabbits.¹²⁶

Metabolism databases and several predictive software packages also have been reviewed.¹²⁷ A knowledge-based expert system for the prediction of phase I and II biotransformations called META was developed on the VAX/VMS platform.¹²⁸ META contains over 750 biotransformations based on substructures and quantum mechanical calculations¹²⁹ that gave excellent predictions on test data and have been optimized using a genetic algorithm to perform better than human experts.¹³⁰ However, when used to predict the metabolism of 42 polycyclic aromatic hydrocarbons (PAHs), META over-predicted 29 and missed 8 of 72 experimentally observed epoxidations, and missed 27 of 49 experimentally observed hydroxylations.¹³¹

E. Excretion

The biliary excretion of drugs has been discussed in a comprehensive text by Smith,¹³² who noted that extremely polar or nonpolar compounds are poorly excreted in the bile. A particularly interesting finding by Hirom *et al.*¹³³ is that above a species-specific molecular weight (MW) threshold, compounds are increasingly excreted in the bile as their MW increases. For nitroimidazoles and nitrothiazoles, a parabolic relationship exists between $\log P$ over the range -1.5 – 1.5 and urinary excretion.¹³⁴ A study of nine compounds with differing physicochemical/pharmacokinetic properties suggested that compounds with low MW, low lipophilicity, and ionic character are eliminated renally and not through the bile, whereas larger, more lipophilic, unionized compounds are not eliminated renally, but through the bile.¹³⁵ Compounds that are highly protein bound cannot be filtered by the glomerulus in the kidney and are thus excreted in the bile.¹³⁶ Molecular connectivity indices have been used to model percent renal elimination for a set of 14 hypoglycemic drugs with moderate results ($r = 0.7557$).¹⁰⁴ FALS has been used to classify 373 drugs into three levels of percent urinary elimination for three groupings: aromatics, nonaromatics, and heteroaromatics with predictive r values ranging from 0.768 to 0.905.¹⁰⁷ For a series of renin inhibitors, MW correlates highly ($r^2 = 0.95$) with biliary elimination rate.¹³⁷ For a series of nine glycopeptide antibiotics, clearance, urinary recovery, and V_d decreased and half-life increased as their pI decreased.¹³⁸

VIII. OPTIMIZATION PHILOSOPHY

The current approach to pharmacokinetics/pharmacodynamics and toxicology in the preclinical research phase has been described as a “medieval science.”¹³⁹ Historically, the goal of drug discovery efforts has been limited to finding a highly active molecule. Once a lead compound has been found or designed, it is passed on to a medicinal chemistry team (“thrown over the wall,” Fig. 3). It is to be “optimized” in a sequential process, first varying the structure to further optimize activity (if necessary), then varying the structure to enhance absorption, metabolism, distribution, excretion, and toxicology properties, one by one in sequence, as problems arise during compound evaluation *in vitro* or *in vivo*.

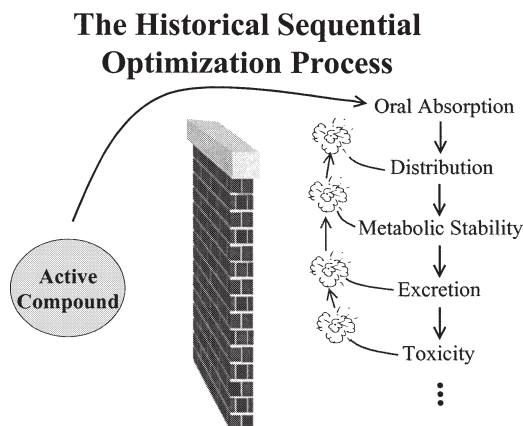

FIGURE 3 The historical sequential process of compound optimization, depicting difficulties in sequentially achieving ADME/toxicity properties that are good.

This process may be viewed as a constrained optimization or, more simply, as a multifactor optimization. The constrained optimization viewpoint considers the various possible structural changes as factors and the goal of optimization as making a drug, which is defined by the general conditions of good activity, selectivity, ADME, and toxicity as the constraints. Reduction to the equivalent, but simpler, multifactor view considers the factors that undergo optimization to be activity, selectivity, ADME, and toxicity, which all are interrelated by structure. Unfortunately, the well-known and proven theories of experimental design and optimization, developed by the groundbreaking work of the statistician R. A. Fisher¹⁴⁰ during the period 1925–1935, require that multiple factors be adjusted simultaneously during optimization; otherwise, the effects of any interactions between the factors are not revealed and cannot be taken into account. Hunter¹⁴¹ clearly and concisely summarized the point: “Experiments in which one factor at a time was varied were shown to be wasteful and misleading.”

Coupled with our imperfect knowledge of biological systems, this one-factor-at-a-time (OFAT) methodology¹⁴² is a major cause of a common problem wherein the enhancement of one property degrades the compound’s quality as measured on another property¹⁴³; for example, a structural change that increases absorption makes the compound metabolically unstable or reduces activity. Sequential optimization may even “back the optimization into a corner,” where initial structural design changes make it impossible to meet requirements imposed later in the sequential optimization process, when simultaneous optimization may have been able to find an area of chemical space where all the criteria could be met. This is possible because the *entirety* of chemical space allowed by all factors is available for consideration in simultaneous optimization and the interrelationships between factors are taken into account. Part of the solution to the problem of development failures caused by poor ADME/toxicity properties requires that the pharmaceutical discovery and development process must move from the OFAT methodology to a *simultaneous* optimization process, incorporating the current and near-future

developments from *in silico* and *in vitro* ADME/toxicity screening, informatics, and modeling into the search for novel therapeutic compounds.

IX. APPLYING EXISTING ADME MODELS TO COMBINATORIAL LIBRARY DESIGN

The chemical space available for the virtual screening of combinatorial libraries is enormous. One simplistic (yet conservative) estimate put the number of possible molecules that could be constructed from 30 atoms limited to C, N, O, or S to be on the order of 10^{60} molecules.¹⁴⁴ As Walters *et al.*¹⁴⁵ pointed out, most molecules that can be made are likely to be unsuitable candidates for drug discovery. Virtual screening of this potential chemical space requires that enumeration of such a huge number of molecules be avoided while still being able to cull out large numbers of undesirable molecules. The REOS program used at Vertex¹⁴⁵ incorporates over 200 ADME/toxicity filters for virtual screening and has been used to cull a virtual library of 30 million compounds down to 200,000 compounds.¹⁴⁶ However, further improvements are necessary to achieve the full potential of multiproperty design.

There are two general concepts to consider in guiding the process. First, the nature and speed of the computational models used, combined with the size of the virtual library, dictate what approach is used. There is a considerable difference in scale of computational power required for screening 10,000, 1 million, or 100 million compounds *in silico*. Models may be rapidly or slowly computed because of the choice of model form and descriptors; changing the form and/or descriptors likely will impact the accuracy of the model predictions. In particular, the use of multiple 3D conformers would be quite expensive, whereas simple 2D derived descriptors are much faster (100+ times). Thus, to screen very large virtual collections, fast, approximate models are necessary, but as the number of molecules computationally screened decreases, the speed of the models also may be decreased to, hopefully, provide more accurate predictions. Even a single, relatively slow model could become a rate-limiting step, and this poses a problem when future uses of ADME models almost certainly will be simultaneous. Thus, the design of novel and rapid algorithms for the prediction of ADME properties should be a fertile area for future research.

Second, the implementation of applying filters cannot treat those filters as independent of one another, as discussed in the foregoing optimization section. Molecular properties are dependent on structure, and the optimization of all properties has to occur simultaneously to achieve the best possible results. As related earlier, optimizing for diversity^{147–149} is no longer the sole goal. A variety of algorithms that have been applied to diversity optimization may be readily adapted to the task optimizing multiple properties in addition to diversity.^{150–154} The search space for these algorithms may be a mix of product-based and reagent-based strategies, as recent work indicates that descriptors can behave differently in product versus reagent space,¹⁵⁵ expanding upon previous results that concluded product-based strategies to be superior to reagent-based strategies.¹⁵⁶

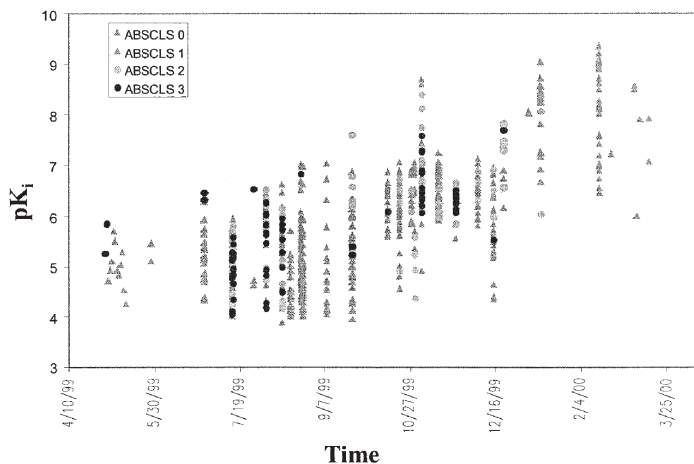

FIGURE 4 Plot of the success of simultaneous optimization of pK_i and predicted absorption over time for an optimization project at Pharmacopoeia Laboratories. Predicted absorption classes (ABSCLS) are 0 (good), 1 (moderate, 2 (poor), and 3 (bad). Caco-2 cell permeability studies confirm the general trend of absorption predictions (results not shown).

Two examples are the design of libraries constrained to possess CNS druglike properties¹⁵⁷ and druglike physicochemical properties.¹⁵⁸ Pickett *et al.*¹⁵⁹ utilized a Monte Carlo search procedure to select and filter compounds designed with a pharmacophore model so that they met absorption constraints as set by the rule of 5 and a PSA limit of 140. They achieved excellent results, enhancing both absorption (as measured by the Caco-2 cell permeability assay) and activity. We have achieved similar results in an optimization project at Pharmacopoeia Laboratories. Introduction and use of an absorption/BBB model¹⁶⁰ aided chemists both to identify the current absorption potential of existing compounds and to determine future synthetic strategies, culminating in the simultaneous optimization of active (<1 nM) compounds with high absorption, as measured by the Caco-2 cell permeability assay (Fig. 4).

X. THE FUTURE OF ADME MODELING

Future progress in the area of ADME modeling requires that each specific property be modeled separately. Considering properties separately avoids, as much as possible, confounding and interfering effects, for example, percentage bioavailability (BA) is determined primarily by both absorption and metabolism, and any attempt to model BA requires that both properties be taken into account. This requires considerably more and better quality data. No longer can the pharmaceutical industry stop at just obtaining ADME data for a series or project of interest, because such data are limited in size and scope, leaving huge areas of chemical space unexplored. These data are also generally inconsistent, due to significant inter- and intralaboratory variation, and thus are not suitable for modeling efforts. Well-designed, comprehensive experiments (Fig. 5) can provide much more information, allowing more

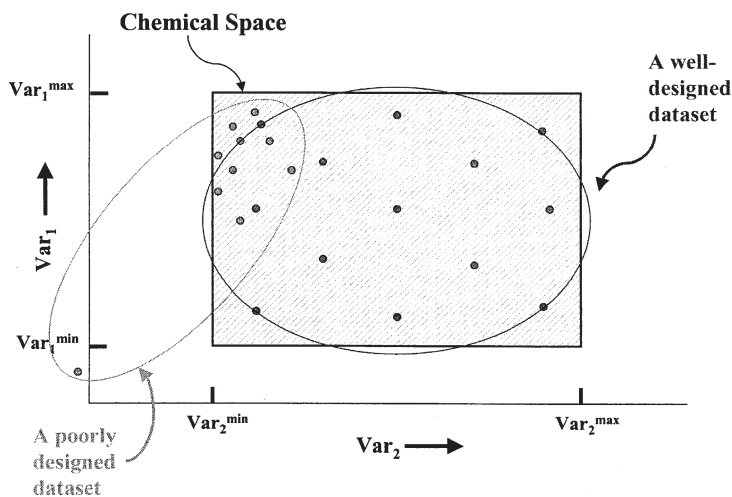

FIGURE 5 Comparison of a designed data set with good coverage of chemical space versus an example of the commonly available, series specific data sets that do not cover chemical space and often have outliers.

fruitful modeling efforts.^{44, 161} More and better data increase the feasibility that models can correctly predict each of the various ADME properties at the 70%+ level. Simultaneous optimization of all drug properties using these individual property models should greatly enhance the success rates of the pharmaceutical industries' drug discovery and development efforts.

There is one caveat, however. Computational models by their very nature, are dependent on the data used to create them and on the understanding and insight of the scientists who created those models. This makes computational models imperfect, because our data and understanding are imperfect, and although reasonably good models are feasible in the near future, error rates of 10–30% or greater cannot be ignored. A significant advantage provided by large combinatorial libraries is the ability to search chemical space thoroughly, thereby uncovering subtle features of structure–activity and structure–property relationships that might otherwise be completely missed. A small set of compounds optimized for diversity and ADME properties will have a lower probability of uncovering a major change in activity–property due to an apparently innocuous structural change, for example, replacement of a methyl group by an ethyl group, which renders a compound inactive. This is because the sampling of the chemical space is insufficient to achieve the necessary resolution when such small collections of compounds are used. Combinatorial chemistry offers the opportunity to partially offset the limitations imposed by imperfect knowledge, at relatively minor cost, through the use of large libraries that will increase the likelihood of detecting subtle relationships.

XI. HIGH-THROUGHPUT SCREENING AND COMBINATORIAL CHEMISTRY

Over the past 40 years, advances in the fields of medicinal chemistry and biochemistry have led to revolutionary changes in our understanding of

drug action. Pharmaceutical companies have taken advantage of this knowledge to establish novel bioassays to find new medicines for old diseases. As specific biological targets were identified that showed strong relationships with disease, mechanistic-based assays could be efficiently developed *in vitro*, leading to the concept of screening compound collections against a variety of therapeutically relevant targets. Large standing inventories of chemically well-characterized compounds provided pharmaceutical companies with a means to add tremendous value to the screening of old compounds for new biological activities.

With the introduction of laboratory robotics during the 1980s, automation of biological assays was possible that allowed large numbers of assays to be run in parallel. The concept of HTS evolved where compound collections could be evaluated efficiently through assay automation. A close working relationship between biochemistry, molecular biology, engineering, and information technologies with HTS groups emerged, resulting in fully integrated platforms for approaching drug discovery. Combinatorial chemistry provided a means to fill gaps in chemical diversity space and led to an expansion of existing compound collections. As the number of compounds continued to increase, the demand for more efficient management of costs, reagents, and time associated with the screening of these compounds for biological activity necessitated the drive to develop improved throughputs through assay miniaturization and automation. Ultrahigh-throughput screening (uHTS) platforms, those capable of generating 100,000 data points per day, are being developed based on assay miniaturization technology, and their aim is to increase throughput and efficiency of screening, thus providing a further acceleration in the drug discovery process.

XII. ASSAY PLATE FORMATS: MOVE TO MINIATURIZATION

Both chemistry and biology have converged on a common 96-well microtiter format as a convenient means of combinatorial synthesis, purification, compound storage, and drug screening. Solvent-resistant polypropylene plates are suitable for compound synthesis/compound storage, whereas polystyrene plates are best used for biological assays. Compound evaluation in this plate format has become the norm, and choices between a number of available plate types support a wide range of bioassays. Current plate options include clear, opaque (white or black), opaque with clear bottoms, tissue culture-treated plates, and plates with special coatings. For separation-based assays, filter bottom plates are available with various options for filter membrane material. Assay volumes in the 50–100- μ l range allow target-based screens to be developed, including enzyme-receptor-, and cell-based assays using radioactive and nonradioactive detection methods. A number of manufacturers offer a variety of liquid-handling devices with single, 8-, and 96-channel dispensing capabilities.¹⁶² Routinely, 10,000 data points per day can be generated in these assay systems. For many years the 96-well plate was the standard microtiter plate format due to its convenience and ubiquity. However, limitations in sample throughput and required reagent quantities have pushed the demand for newer, more efficient technologies.

An advancement in the screening of large collections of compounds that has had an impact on screening efficiencies is assay miniaturization. The development of assay plates with the same footprint as the 96-well microtiter plate, but with increasingly higher density arrays (e.g., 384, 864, 1536, and 3456), has led to benefits in reduction of compound and reagents required for an assay and the time taken to run the screen. Whereas libraries are often synthesized on solid support, sample yields can be small, forcing limited assay volumes to achieve adequate compound concentrations. The move from 96- to 384-well plates has reduced assay volumes from 50 to 20 μl and increased the efficiencies of screening large numbers of compounds. Libraries currently archived in 96-well plates are easily mapped onto 384-well plates. Today, instruments have been specifically designed to allow 384-well assays to be run on a routine basis. Plate readers are commercially available for all standard detection systems, as well as automated liquid handlers and plate washers. Assay formats originally developed in 96-well plates can, in general, be formatted into lower assay volume, 384-well plates. Various detection technologies, such as prompt fluorescence, time-resolved fluorescence, fluorescence resonance energy transfer (FRET), fluorescence polarization, and luminescence have been used to develop screens into 384-well formats. The choices today for various 384-well plate types are now as broad as the options for 96-well plates, including tissue culture-treated to support cell-based assays and plates with special coatings. Overall efficiency gains using 384-well plates versus 96-well plates can reach over twofold in assay throughput and lower requirements for reagent use.

A. 1536-Well Technologies

Current efforts have focused on even higher well densities and smaller assay volumes (*vide supra*). Assay formats such as 1536 are gaining more acceptance in the uHTS arena: initial promising results have been reported in 1–10 μl assay volumes. High-density 1536-well plates can be used to screen 16 times the number of compounds as the standard 96-well plate in the same convenient footprint. As interest is generated in this format, instrument manufacturers will provide the new technologies required to bring 1536-well plates to the level where 96-well formats are today.

To assemble a 1536-well technology platform, a number of logistical problems arise: compound handling, assay development, liquid handling, and informatics. Each piece needs attention before this technology becomes common practice. Some of the key equipment components have been developed and are currently commercially available. Assay plates with a working volume of 4–10 μl can be purchased in a variety of plate types that can be used in many standard assay designs. Plate readers also have been designed to read 1536-well plates either one well at a time or using cooled charge-coupled device (CCD) camera technology to image the entire plate. Field imaging using a cooled CCD camera allows the entire plate to be imaged in a single step, which takes as little as 100 ms, depending on the sensitivity required. Assays being developed in these plates are moving away from colorimetric and radiochemical methods of detection toward highly sensitive techniques that involve fluorescence polarization, prompt and time-resolved fluorescence, and chemiluminescence

that can be rapidly quantified using imaging systems. Liquid handling issues can be addressed using volumetric displacement instrumentation such as the CyBio CyBiWell (Jena, Germany) and the Robbins Hydra (Sunnyvale, CA) fixed tip syringe system. These instruments work well in the low microliter volume range that requires contact dispensing for reagent delivery.¹⁶²

An option to move to lower assay volumes but maintain the 1536-well format is the commercially available Corning (Acton, MA) low-profile, wafer plate. This plate type, which was designed in collaboration with Pharmacopoeia, Inc. (Princeton, NJ), is optimal for CCD imagers because of its low profile, which assures an optically thin sample that is less affected by shading artifacts. Liquid handling issues using the Corning wafer, 1536-well plate have been more of a challenge with working assay volumes of 1–1.5 μ l. Standard liquid handling systems do not work well in dispensing submicroliter volumes with contact dispensing. An alternative means of dispensing reagents into test plates uses microdroplet, noncontact dispensing, for example, the PixSys3200 manufactured by Cartesian Technologies, Inc. (Irvine, CA). Using a modified version of this system, it is possible to deliver assay reagents rapidly in volumes from 100 nl to 2 μ l per well across a 1536-well plate. Reagent dispensing can take as little as 2 min per plate. Microdroplet dispensing has the advantage that it minimizes the risk of cross-contamination during reagent dispensing. A fluorescence-based, enzyme assay was reported recently that uses microdroplet, noncontact dispensing in which a 2 million-member combinatorial compound collection was screened in a miniaturized, 1536-well, 1.5- μ l assay format.¹⁶³

B. Summary

Manufacturers of plates, liquid handling systems, and plate readers that are compatible with 384-well plates have contributed significantly to making this transition possible. 384-well technologies have led to a significant decrease in the number of assays being run in 96-well formats. For example, greater than 2 million compounds were screened against each of 29 biological targets over the last year in our Company. Of these targets, 22 (76%) of the assays were screened in 384-well format, whereas only 5 assays were run in 96-well plates. Early in this process, the entire compound collection was reformatted from 96-well to 384-well plates, resulting in an overall savings of greater than two-fold in screening throughput times and compound/bioreagent requirements. The remaining two assays were screened using the even higher density Corning wafer 1536-well plates in a 1.5- μ l assay volume. The assay development and screening process for one of these assays is described in detail elsewhere.¹⁶³ A number of technology issues have been addressed concerning plates, liquid handling systems, methods of detection, and automated data analysis. It is possible to format an entire million-compound collection into 1536-well plates. With such ready availability, the number of assays that use this technology will increase significantly.

XIII. NONSEPARATION OR HOMOGENEOUS ASSAYS

The ability to run assays that require a separation step becomes limited as assay volumes are reduced in higher density array plates. Therefore, “mix-and-read” or homogeneous screening formats are essential to miniaturization, requiring only a series of additions to perform the screen. Examples of homogeneous assay formats that have been developed for low volume screens include prompt fluorescence, FRET including time-resolved FRET, fluorescence polarization, and laser scanning fluorimetry.

FRET has been developed successfully for several biological targets in 1536-well format. FRET occurs between two fluorescent molecules—a donor and an acceptor. When these molecules are brought into close proximity, the donor transfers its energy directly to the acceptor. The two fluorescent molecule pairs are selected so that the emission wavelength of the donor overlaps the excitation wavelength of the acceptor. If the donor and acceptor are within close proximity to each other (generally less than 50 Å), the fluorescence is quenched through intermolecular energy transfer. This technology has been developed successfully for protease enzyme assays including HIV protease¹⁶⁴ and, in 1536-well plates, plasmepsin.¹⁶⁵ For each protease, a peptide substrate separates the donor, 5-[(2'-aminoethyl)amino]naphthalenesulfonic acid, that is paired with the acceptor, 4-[[4'-(dimethylamino)phenyl]-azo]benzoic acid. When the separation is disrupted through protease cleavage, an increase in fluorescence intensity results. A variation of FRET, called time-resolved FRET also has been developed in a homogeneous format. Helicase-mediated DNA unwinding was monitored through energy transfer between a lanthanide chelate as the fluor and tetramethyl rhodamine (TMR) as the lanthanide quencher.¹⁶⁶ The chelate was covalently linked to the free 5'-amino terminus of the oligonucleotide, whereas the quencher was attached on the 3'-amino terminus of the complementary oligonucleotide. The emission energy from the lanthanide chelate is quenched through nonradiative transfer to the proximal TMR in the duplex substrate. Separation of the two complementary DNA strands by helicase unwinding activity causes a cessation of the fluorescence energy transfer and results in an increase in time-resolved fluorescence. Similar assay performance was reported in 96-, 384-, and 1536-well formats.

Fluorescence polarization (FP) provides a convenient, highly sensitive technology for homogeneous formats. When a fluorescently labeled, small molecule ligand binds to a large molecule, its rotation slows, causing an increase in fluorescence polarization as compared to the low polarization of the unbound, freely rotating ligand. This change in fluorescence polarization between free and bound ligand can be used to quantify the binding of small molecules to large molecules. Aquest (LJL, Sunnyvale, CA) and Victor V (Perkin-Elmer Life Sciences, Gaithersburg, MD) are commercially available instruments that perform FP in 1536-well plates. A number of homogeneous assays have been developed using fluorescence polarization to monitor kinase¹⁶⁷ and protease¹⁶⁸ activity as well as peptide ligand binding to G-protein coupled receptors.¹⁶⁹ With currently available fluors, the upper limit of molecular weight of small fluorescently labeled ligands is <5000 Da. Newer

fluors with longer lifetimes are being developed to expand this molecular weight range.

Applied Biosystems (Foster City, CA), in collaboration with Biometric Imaging (Mountain View, CA), has developed an automated confocal imaging system suited to homogeneous formats.¹⁷⁰ Fluorescent cells or beads are detected as localized areas of concentrated fluorescence, whereas the unbound fluorophore, which comprises the background signal, is ignored. This instrument provides two emission channels centered at 685 nm to provide maximum emission separation between the two fluorescent dyes, Cy5 and Cy5.5. This separation allows two-color analysis to be performed and thereby permits multiplexing of assays within a single well. Bead-based immunocapture assays have been reported using an antigen capture antibody attached to the bead and a second Cy5 antibody to quantify antigen capture. All assay reagents are incubated together, instead of sequentially with wash steps as in a traditional enzyme-linked immunosorbent assay (ELISA). Furthermore, a standard ELISA requires coating the entire well bottom with assay reagents, whereas in bead-based immunocapture, only beads with much less surface area are coated, resulting in a >100-fold reduction in reagent needs. The confocal imaging system also can detect fluorescently labeled ligand binding to cell surface receptors, thereby eliminating the use of traditional radioligands in binding assays. The binding of a fluorescent peptide ligand can be accomplished in a one-step, homogeneous format, eliminating the need to separate bound from free ligand. Specific binding has been demonstrated for Cy5 labeled Neuropeptide Y (NPY) bound to Chinese hamster ovary (CHO) K1 cells transfected with the Y1 and Y2 receptor subtypes, but not nontransfected cells. Because this scanning platform generates 1-mm² images of the well bottom, both 96- and 384-well homogeneous assays work equally well. Further instrument modifications are ongoing to make this technology suitable for 1536-well formats.

XIV. IDENTIFICATION OF RECEPTOR ANTAGONISTS FOR CHEMOKINE RECEPTOR AND BRADYKININ-1 BY SCREENING A 150,000-MEMBER COMBINATORIAL LIBRARY

Inclusion of subtly different substituents in a combinatorial library may increase its size substantially as well as increase the probability of finding an active compound. Therefore, the larger is the library, the higher is the sampling density of diversity space. To illustrate this point, a case study is presented where two G protein coupled receptor targets are screened against a large combinatorial library (~150,000 members). Activity was observed in only a small portion of this library, demonstrating that subtle differences in chemical structure can lead to active compounds. High-throughput screening was conducted on this library to identify antagonists of the chemokine receptor, CXCR2, and the bradykinin-1 (BK-1) receptor subtype. Solid phase library synthesis was performed using encoding technology to provide a means of efficiently defining each member of this 150,000-member library.^{15, 16} This encoding process allows structural assignment of active compounds identified in the high-throughput screens (Fig. 6).^{171, 172}

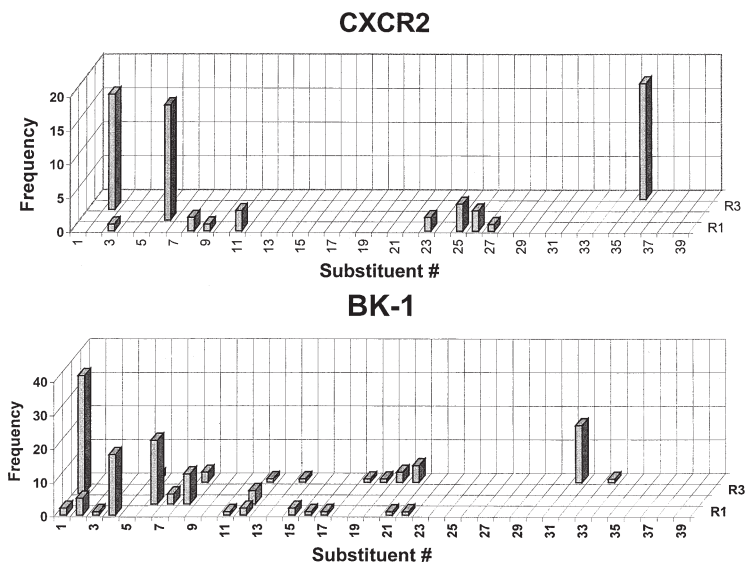

FIGURE 6 Frequency of each substituent at R1, R2, R3, and R4 in structures active against CXCR2 (upper panel) and BK-1 (lower panel). Active structures predicted from the encoded library, against either CXCR2 or BK-1 receptors, are evaluated in terms of substituents at each point of variation. The frequency with which each substituent is found in the active structures is indicated in comparison to all other possibilities at that position: R1 = 31; R2 = 31; R3 = 4; R4 = 38.

The initial screening against the CXCR2 and BK-1 receptors was performed in a 96-well plate format at approximately 20 compounds per well, where 50% of the bead eluate was removed and used in the biological assay. Once an active well was identified, the bead mixtures corresponding to that well were arrayed at one bead per well and the remaining compound was eluted. The individual compounds were rescreened to identify the active compound from each original mixture. The bead that contained the active compound was then analyzed to identify the encoding molecules and to assign the chemical structure. Because the split synthesis strategy results in a random population of beads, screening of individual compounds is statistical. Screening three copies of the library or 450,000 compounds results in over 95% of all compounds in the library being evaluated at least once and many members being screened multiple times.

The 150,000-member combinatorial library was designed with a core structure that contains four points of variation. This library was constructed with 31 possible substituents at R1, 31 at R2, 4 at R3, and 38 substituents at R4. Using the preceding screening paradigm, the CXCR2 receptor was screened against the 150,000-member library, resulting in the identification of 17 actives, 8 of which are unique. Thus the overall hit rate for this collection was only 0.005%. By examining the frequency of occurrence of each substituent at each point of variation for the active compound set, regional structural bias for a biological target can be ascertained. The graph in Figure 6 plots the distribution and frequency of substituents at the R1, R2, R3, and R4 positions of the structures active against the CXCR2 receptor. Of note, in

the case of three of the four substituents identified in the screen, only a single choice among all possibilities appeared in the active set, indicating that a limited structural motif was accepted by this receptor. One of these compounds was resynthesized and shown to inhibit IL-8 binding to the CXCR2 receptor with a K_i value of 500 nM. No cross-reactivity with the closely related CXCR1 receptor (77% amino acid identity) was observed with this compound. Further optimization of the lead series resulted in a 10-fold increase in activity and demonstrated efficacy in a CXCR2-dependent animal model. Compounds that have high Caco-2 cell permeability have been developed using an internal Pharmacopoeia absorption prediction model.¹⁶⁰

BK-1 selective receptor antagonists also were identified from this 150,000-member library using similar screening strategies.¹⁷³ Like CXCR2 activity, the resulting SAR was very tight, with a hit rate of 0.013% that identified 20 closely related structures. Three structures were chosen for resynthesis: the most potent yielded a K_i value of 200 nM at the BK-1 receptor. This compound was shown to be inactive at the BK-2 receptor subtype. Exploration of the lead series through parallel synthesis resulted in a selective BK-1 receptor antagonist with enhanced potency (3 nM). Further studies indicated that this series of BK-1 antagonists show *in vivo* efficacy in a BK-1 receptor dependent primate animal model.

Clear differences in structural bias are seen for compounds active at the BK-1 and CXCR2 receptors, even though activity was identified in the same library. Substituent preferences at each point of variation for the active BK-1 versus CXCR2 compound set illustrate the structural bias for each biological target (Fig. 7). For CXCR2, single synthons at R2, R3, and R4 were identified with synthon preferences corresponding to the numbers 6, 2, and 35, respectively. In contrast, BK-1 greatly preferred synthons 8 and 11 at R2, synthon 1 at R3, and synthon 33 at R4, indicating clear distinction in structural bias between these two receptors. Furthermore, diversity analysis of the library and the positioning of the active structures in diversity space demonstrated that although activity for BK-1 and CXCR2 was identified from the same library, the active compounds fall within nonoverlapping space. Even by expanding the number of compounds through medicinal chemistry efforts, the active compounds still occur in nonoverlapping diversity space. Furthermore, a detailed analysis of the clustered areas indicates that many structures with similar diversity parameters lie within these regions, but are inactive at their respective receptors. Thus, similarity in structure does not ensure activity even within a single library.

These two case studies illustrate that the screening of combinatorial chemical libraries allows identification of lead compounds against biological targets with strict structural requirements. For those targets with limited structure-based information, the use of large combinatorial libraries, constructed with no bias for the biological target, provides a means to identify novel classes of compounds. Encoding technologies offer the advantage of designing libraries with large numbers of compounds and, therefore, significantly accelerate the pace with which new lead structures are identified. The screening results for CXCR2 and BK-1 demonstrate a relatively narrow SAR when screened against a 150,000-member library. The active structures identified for CXCR2 con-

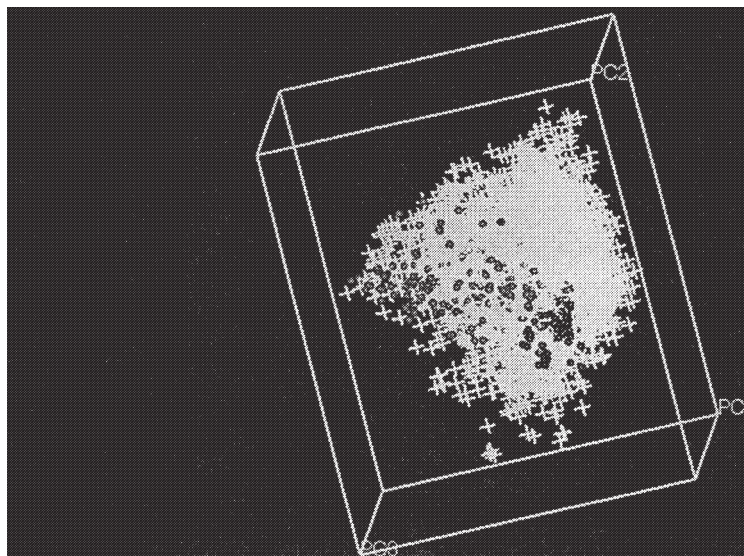

FIGURE 7 The 150,000-member library was plotted in diversity space using a 5% sampling of the entire library. The darker circles in the lower right portion of the figure represent decoded, active structures identified in the screen for CXCR2 along with analogues generated through medicinal chemistry efforts. The gray circles represent active structures and analogues shown to be active for BK-I.

tained a single substituent in three of the four R groups. The high degree of selectivity toward a small number of substituents at a given R group suggests that if this library were constrained in size by even ~ 4000 compounds (2.6%), the active pharmacophore may not have been identified. Improved odds of identifying structures active against these biological targets occurred by increasing the sampling density of diversity space. Thus, uncovering subtle features in SARs against a particular target may involve the screening of large libraries, but, in the end, will increase the likelihood of finding an active compound.

To ensure maximal diversity, compound collections, in general, are growing at a significant rate. As more combinatorial libraries contribute to these collections and numerous new biological targets become available through genomics efforts, the challenge then becomes to design efficient methods to characterize members of these libraries for biochemical and functional activities. The use of encoding technology provides a means to synthesize large libraries (20,000–100,000 compounds), resulting in collections of over 2 million compounds being standard. The bottleneck in this process then becomes developing new HTS technologies to handle adequately the number of compounds that are available for assay against any one target.

XV. STRUCTURE-BASED DESIGN OF SOMATOSTATIN AGONISTS

Combinatorial libraries with no *a priori* structural bias for a particular biological target can be used to identify lead structures and provide significant

structural information that can be used for further compound optimization through design of subsequent focused libraries. Similarly, when structural knowledge of the target is available, this information can serve as a starting point for focused library synthesis. This approach was used successfully to identify subtype specific, nonpeptide agonists of the somatostatin receptor.¹⁶¹ Combinatorial libraries were constructed on the basis of molecular modeling of known peptide agonists. The pharmacophore was identified as a tripartite in structure with an aromatic ring, a tryptophan nucleus, and a diamine moiety, making it amenable to combinatorial chemistry synthesis. A library of approximately 130,000 compounds was synthesized with 79 different substituents representing the aromatic moiety, 20 substituents for the Trp-amino acid moiety, and 20 diamines ($79 \times 20 \times 20$). Screening of this library was performed against the five known subtypes of the somatostatin receptor, sst1, sst2, sst3, sst4, and sst5. Active compounds were chosen based on potency and receptor subtype selectivity profile. The identity of each subtype selective compound present in active mixtures was determined using an iterative deconvolution process with resin archived from each step of the original synthesis. A selective and potent class of lead structures was identified from this initial library that served as a template in the design of a second more complex library ($21 \times 22 \times 147$). Receptor binding data generated from the first two libraries were used in the design of two additional libraries of aryl-indole compounds. Through this sequential approach in library design it was possible to generate high affinity, subtype selective agonists for each of the five somatostatin receptors. These compounds were then used to dissect the functions of the individual receptors, thus demonstrating the role of sst2 in inhibition of glucagon release from pancreatic α -cells and sst5 receptor as a mediator of insulin secretion from pancreatic β cells.

XVI. CONCLUSIONS

Innovations in combinatorial chemistry have enabled the synthesis of large collections of libraries, which have led to the current efforts in developing methods capable of screening these compounds. Assay miniaturization has allowed assay screening throughput to dramatically increase in recent years. Miniaturization has resulted in a reduction in cost per well in terms of manpower, time to complete the screening cycle, and reduced requirements for compound and assay reagents. As HTS identifies more leads, efforts will focus on relieving downstream bottlenecks in drug adsorption, metabolism, and toxicology. Consideration of druglike properties present in the library members during library design is one of the initial steps that can be taken to enhance the quality of leads identified from HTS. As computational and experimental procedures for ADME/toxicology improve, the identification of problematic leads earlier in the drug discovery process will be possible. Taken together, innovations in chemical synthesis and library design, coupled with screening and bioinformatics technology, will help greatly to decrease drug development times and costs.

REFERENCES

1. Dolle, R. E. Private communication, 1999.
2. Shaw, I. *Scrip Magazine* 6(July/August), 1999.
3. Lipper, R. A. E pluribus product. *Modern Drug Disc.* 2:55–60, 1999.
4. Johnson, D. The discovery–development Interface has become the new interfacial phenomenon. *Drug Discovery Today* 4:535–536, 1999.
5. Parlow J. J., Deuraj, R. V., and South, M. S. Solution-phase chemical library synthesis using polymer-assisted purification techniques. *Curr. Opin. Chem. Biol.* 3:320–336, 1999.
6. Suto, M. J. Developments in solution-phase combinatorial chemistry. *Curr. Opin. Drug Disc. Dev.* 2:377–384, 1999.
7. Dolle, R. E. and Nelson, K. H., Jr. Comprehensive survey of combinatorial library synthesis: 1998. *J. Comb. Chem.* 1:235–282, 1999.
8. Hermkens, P. H., Ottenheijm, H. C., and Rees, D. C. Solid-phase organic reactions: A review of the recent literature. *Tetrahedron* 52:4527–4554, 1996.
9. Hermkens, P. H., Ottenheijm, H. C., and Rees, D. C. Solid-phase organic reactions II: A review of recent literature Nov 95–Nov 96. *Tetrahedron* 53:5643–5678, 1997.
10. Booth, S., Hermkens, P. H., Ottenheijm, H. C., and Rees, D. C. Solid-phase organic reactions III: A review of the literature Nov 96–Dec 97. *Tetrahedron* 54:15,385–15,443, 1996.
11. Fruchtel, J. S. and Jung, G. Organic chemistry on solid supports. *Angew. Chem., Int. Ed. Engl.* 35:17–42, 1996.
12. Osborn, H. M. and Khan, T. H. Recent developments in polymer supported synthesis of oligosaccharides and glycopeptides. *Tetrahedron* 55:1807–1850, 1999.
13. Lorsbach, B. A. and Kurth, M. J. Carbon–carbon bond forming solid-phase reactions. *Chem. Rev.* 99:1549–1581, 1999.
14. Gordon, K. and Balasubramanian, S. Recent advances in solid-phase chemical methodologies. *Curr. Opin. Drug Disc. Dev.* 2:342–349, 1999.
15. Furka, A., Sebestyen, F., Asgedom, M., and Dibo, G. In *Proceedings of the 14th International Congress of Biochemistry*, Vol. 5, p. 47 (abstract). de Gruyter, Berlin, 1989. In *Proceedings of the 10th International Symposium on Medicinal Chemistry*, p. 288 (abstract). Elsevier, Amsterdam, 1989.
16. Furka, A., Sebestyen, F., Asgedom, M., and Dibo, G. General method for rapid synthesis of multicomponent peptide mixtures. *Int. J. Pept. Protein Res.* 37:487–493, 1991.
17. Lam, K. S., Salmon, S. E., Hersh, E. M., Hruby, V. J., Kazmierski, W. M., and Knapp, R. J. A new type of synthetic peptide library for identifying ligand-binding activity. *Nature* 354:82–84, 1991; errata 358:434, 1992; 360:768, 1992.
18. Dillard, L. W., Connelly, J. A., Baldwin, J. J., Horlbeck, E. G., Kirk, G. L., and Lauri, G. Selecting codes to be used for encoding combinatorial libraries. U.S. Patent 5,663,046, 1997.
19. Baldwin, J. J. and Dolle, R. E. Deconvolution tools for solid-phase synthesis. In *A Practical Guide to Combinatorial Chemistry* (A. W. Czarnick and S. H. DeWitt, Eds.), pp. 153–174. American Chemical Society, Washington, D.C., 1999.
20. Floyd, C. D., Leblanc, C., and Whittaker, M. Combinatorial chemistry as a tool for drug discovery. In *Progress in Medicinal Chemistry* (F. D. King and A. W. Oxford, Eds.), Vol. 36, pp. 91–168. Elsevier Science, Amsterdam, Netherlands, 1999.
21. Brenner, S. and Lerner, R. Encoded combinatorial chemistry. *Proc. Natl. Acad. Sci. U.S.A.* 89:5381–5383, 1992.
22. Nielsen, J., Brenner, S., and Janda, K. D. Synthetic methods for the implementation of encoded combinatorial chemistry. *J. Am. Chem. Soc.* 115:9812–9813, 1993.
23. Nikolaiev, V., Stierandova, A., Krchnak, V., Seligmann, B., Lam, K. S., Salmon, S. E., and Lebl, M. Peptide-encoding for structure determination of nonsequenceable polymers within libraries synthesized and tested on solid-phase supports. *Pept. Res.* 6:161–170, 1993.
24. Moran, E. J., Sarshar, S., Cargill, J. F., Shahbaz, M. M., Lio, A., Mjalli, A. M. M., and Armstrong, R. W. Radio frequency tag encoded combinatorial library method for the discovery of tripeptide-substituted cinnamic acid inhibitors of the protein tyrosine phosphatase PTP1B. *J. Am. Chem. Soc.* 117:10,787–10,788, 1995.
25. Nicolaou, K. C., Xiao, X. Y., Parandoosh, Z., Senyei, A., and Nova, M. P. Radiofrequency encoded combinatorial chemistry. *Angew. Chem., Int. Ed. Engl.* 34:2289–2291, 1995.

26. Frank, R. J. Simultaneous and combinatorial chemical synthesis techniques for the generation and screening of molecular diversity *J. Biotechnol.* 41:259–272, 1995.
27. Houghten, R. A. General method for the rapid solid-phase synthesis of large numbers of peptides: Specificity of antigen–antibody interaction at the level of individual amino acids. *Proc. Natl. Acad. Sci. U.S.A.* 82:5131–5135, 1985.
28. Terrett, N. K., Gardner, M., Gordon, D. W., Kobylecki, R. J., and Steele, J. Drug discovery by combinatorial chemistry—the development of a novel method for the rapid synthesis of single compounds. *Chem.—Eur. J.* 3:1917–1920, 1997.
29. Martin, E. J., Blaney, J. M., Siani, M. A., Spellmeyer, D. C., Wong, A. K., and Moos, W. H. Measuring diversity: Experimental design of combinatorial libraries for drug discovery. *J. Med. Chem.* 38:1431–1436, 1995.
30. Brown, R. D. and Martin, Y. C. Use of structure–activity data to compare structure-based clustering methods and descriptors for use in compound selection. *J. Chem. Inf. Comput. Sci.* 36:572–584, 1996.
31. Chapman, D. The measurement of molecular diversity: A three-dimensional approach. *J. Comput.-Aided Mol. Des.* 10:501–512, 1996.
32. Cramer, R. D., Clark, R. D., Patterson, D. E., and Ferguson, A. M. Bioisosterism as a molecular diversity descriptor: Steric fields of single “topomeric” conformers. *J. Med. Chem.* 39:3060–3069, 1996.
33. Lipinski, C. A., Lombardo, F., Dominy, B. W., and Feeney, P. J. Experimental and computational approaches to estimate solubility and permeability in drug discovery and development settings. *Adv. Drug Delivery Rev.* 23:3–25, 1997.
34. Teague, S. J., Davis, A. M., Leeson, P. D., and Oprea, T. The design of leadlike combinatorial libraries. *Angew. Chem., Int. Ed. Engl.* 38:3743–3748, 1999.
35. Prentis, R. A., Lis, Y., and Walker, S. R. Pharmaceutical innovation by the seven UK-owned pharmaceutical companies (1964–1985). *Br. J. Clin. Pharmacol.* 25:387–396, 1988.
36. DiMasi, J. A. Success rate for new drugs entering clinical testing in the United States. *Clin. Pharmacol. Ther.* 58:1–14.
37. Arlington, S. Pharma 2005—An industrial revolution in R&D. *Pharm. Exec.* Jan:74–84, 2000.
38. Navia, M. A. and Chaturvedi, P. R. Design principles for orally bioavailable drugs. *Drug Discovery Today* 1:179–189, 1996.
39. Chan, O. H. and Stewart, B. H. Physicochemical and drug-delivery considerations for oral drug bioavailability. *Drug Discovery Today* 1:461–473, 1996.
40. Smith, D. A., Jones, B. C., and Walker, D. K. Design of drugs involving the concepts and theories of drug metabolism and pharmacokinetics. *Med. Res. Rev.* 16:243–266, 1996.
41. Sinko, P. J. Drug selection in early drug development: Screening for acceptable pharmacokinetic properties using combined *in vitro* and computational approaches. *Curr. Opin. Drug. Disc. Dev.* 2:42–48, 1999.
42. Walters, W. P., Ajay, and Murcko, M. A. Recognizing molecules with druglike properties. *Curr. Opin. Chem. Biol.* 3:384–387, 1999.
43. Lipper, R. A. E pluribus product. *Modern Drug Disc.* 2:55–60, 1999.
44. Tarbit, M. H. and Berman, J. High-throughput approaches for evaluating absorption, distribution, metabolism, and excretion properties of lead compounds. *Curr. Opin. Chem. Biol.* 2:411–416, 1998.
45. Lin, J. H. and Lu, A. Y. H. Role of pharmacokinetics and metabolism in drug discovery and development. *Pharmacol. Rev.* 49:403–449, 1997.
46. Clark, D. E. and Pickett, S. D. Computational methods for the prediction of “drug-likeness.” *Drug Disc. Today* 5:49–58, 2000.
47. Hirono, S., Nakagome, I., Hirano, H., Matsushita, Y., Yoshi, F., and Moriguchi, I. Non-congeneric structure-pharmacokinetic property correlation studies using fuzzy adaptive least-squares: Oral bioavailability. *Biol. Pharm. Bull.* 17:306–309, 1994.
48. Bemis, G. W. and Murcko, M. A. The properties of known drugs. 1. Molecular frameworks. *J. Med. Chem.* 39:2887–2893, 1996.
49. Bemis, G. W. and Murcko, M. A. Properties of known drugs. 2. Side chains. *J. Med. Chem.* 42:5095–5099, 1999.

50. Lewell, X. Q., Judd, D. B., Watson, S. P., and Hann, M. M. RECAP—Retrosynthetic combinatorial analysis procedure: A powerful new technique for identifying privileged molecular fragments with useful applications in combinatorial chemistry. *J. Chem. Inf. Comput. Sci.* 38:511–522, 1998.
51. Wang, J. and Ramnarayan, K. Toward designing drug-like libraries: A novel computational approach for the prediction of drug feasibility of compounds. *J. Comb. Chem.* 1:524–533, 1999.
52. Wagener, M. and van Geerestein, V. J. Potential drugs and nondrugs: Prediction and identification of important structural features. *J. Chem. Inf. Comput. Sci.* 40:280–292, 2000.
53. Sadowski, J. and Kubinyi, H. A scoring scheme for discriminating between drugs and nondrugs. *J. Med. Chem.* 41:3325–3329, 1998.
54. Ajay, Walters, W. P., and Murcko, M. A. Can we learn to distinguish between “drug-like” and “nondrug-like” molecules? *J. Med. Chem.* 41:3314–3324, 1998.
55. Ghose, A. K., Viswanadhan, V. N., and Wendoloski, J. J. A knowledge-based approach in designing combinatorial or medicinal chemistry libraries for drug discovery. 1. A qualitative and quantitative characterization of known drug databases. *J. Comb. Chem.* 1:55–68, 1999.
56. Oprea, T. I. Property distribution of drug-related chemical databases. *J. Comput.-Aided Mol. Des.* 14:251–264, 2000.
57. Conradi, R. A., Burton, P. S., and Borchardt, R. T. Physico-chemical and biological factors that influence a drug’s cellular permeability by passive diffusion. *Methods Principles Med. Chem.* 4:233–252, 1996.
58. Camenisch, G., Folkers, and van de Waterbeemd, H. Review of theoretical passive drug absorption models: Historical background, recent developments and limitations. *Pharm. Acta Helv.* 71:309–327, 1996.
59. Kararli, T. T. Gastrointestinal absorption of drugs. *Crit. Rev. Ther. Drugs Carrier Syst.* 6:39–86, 1989.
60. Camenisch, G., Folkers, G., and van de Waterbeemd, H. Review of theoretical passive drug absorption models: Historical background, recent developments and limitations. *Pharm. Acta Helv.* 71:309–327, 1996.
61. Palm, K., Stenberg, P., Luthman, K., and Artursson, P. Polar molecular surface properties predict the intestinal absorption of drugs in humans. *Pharm. Res.* 14:568–571, 1997.
62. Clark, D. E. Rapid calculation of polar molecular surface area and its application to the prediction of transport phenomena. 1. Prediction of intestinal absorption. *J. Pharm. Sci.* 88:807–814, 1999.
63. Kelder, J., Grootenhuis, P. D. J., Bayada, D. M., Delbressine, L. P. C., and Ploemen, J. Polar molecular surface as a dominating determinant for oral absorption and brain penetration of drugs. *Pharm. Res.* 16:1514–1519, 1999.
64. Camenisch, G., Alsenz, J., van de Waterbeemd, H., and Folkers, G. Estimation of permeability by passive diffusion through Caco-2 cell monolayers using drugs’ lipophilicity and molecular weight. *Eur. J. Pharm. Sci.* 6:313–319, 1998.
65. Camenisch, G., Folkers, G., and van de Waterbeemd, H. Shape of membrane permeability–lipophilicity curves: Extension of theoretical models with an aqueous pore pathway. *Eur. J. Pharm. Sci.* 6:321–329, 1998.
66. Wright, E. M. and Diamond, J. M. Patterns of non-electrolyte permeability. *Proc. R. Soc. London, Ser. B* 172:227–271, 1969.
67. Diamond, J. M. and Wright, E. M. Molecular forces governing non-electrolyte permeation through cell membranes. *Proc. R. Soc. London, Ser. B* 172:273–316, 1969.
68. van de Waterbeemd, H., Camenisch, G., Folkers, G., and Raevsky, O. A. Estimation of Caco-2 cell permeability using calculated molecular descriptors. *Quant. Struct.-Act. Relat.* 15:480–490, 1996.
69. Norinder, U., Osterberg, T., and Artursson, P. Theoretical calculation and prediction of Caco-2 cell permeability using MolSurf parametrization and PLS statistics. *Pharm. Res.* 14:1786–1791, 1997.
70. Norinder, U., Osterberg, T., and Artursson, P. Theoretical calculation and prediction of intestinal absorption of drugs in humans using MolSurf parametrization and PLS statistics. *Eur. J. Pharm. Sci.* 8:49–56, 1999.

71. Wessel, M. D., Jurs, P. C., Tolan, J. W., and Muskal, S. M. Prediction of human intestinal absorption of drug compounds from molecular structure. *J. Chem. Inf. Comput. Sci.* 38:726–735, 1998.
72. Winiwarter, S., Bonham, N. M., Ax, F., Hallberg, A., Lennernas, H., and Karlen, A. Correlation of human jejunal permeability (*in vivo*) of drugs with experimentally and theoretically derived parameters. A multivariate data analysis approach. *J. Med. Chem.* 41:4939–4949, 1998.
73. Tsuji, A. and Tamai, I. Carrier-mediated intestinal transport of drugs. *Pharm. Res.* 13:963–977, 1996.
74. Walter, E., Kissel, T., and Amidon, G. L. The intestinal peptide carrier: A potential transport system for small peptide derived drugs. *Adv. Drug Delivery Rev.* 20:33–58, 1996.
75. Swaan, P. W., Szoka, F. C., Jr., and Oie, S. Use of the intestinal and hepatic bile acid transporters for drug delivery. *Adv. Drug Delivery Rev.* 20:59–82, 1996.
76. Swaan, P. W. and Tukker, J. J. Molecular determinants of recognition for the intestinal peptide carrier. *J. Pharm. Sci.* 86:596–602, 1997.
77. Bailey, P. D., Boyd, C. A. R., Bronk, J. R., Collier, I. D., Meredith, D., Morgan, K. M., and Temple, C. S. How to make drugs orally active: A substrate template for peptide transporter PepT1. *Angew. Chem., Int. Ed. Engl.* 39:506–508, 2000.
78. Swaan, P. W., Szoka, F. C., Jr., and Oie, S. Molecular modeling of the intestinal bile acid carrier: A comparative molecular field analysis study. *J. Comput.-Aided Mol. Des.* 11:581–588, 1997.
79. Hunter, J. and Hirst, B. H. Intestinal secretion of drugs: The role of P-glycoprotein and related drug efflux systems in limiting oral drug absorption. *Adv. Drug Delivery Rev.* 25:129–157, 1997.
80. Seelig, A. A general pattern for substrate recognition by P-glycoprotein. *Eur. J. Biochem.* 251:252–261, 1998.
81. Doepenschmitt, S., Spahn-Langguth, H., Regrdh, C. G., and Langguth, P. Role of P-glycoprotein-mediated secretion in absorptive drug permeability: An approach using passive membrane permeability and affinity to P-glycoprotein. *J. Pharm. Sci.* 88:1067–1072, 1999.
82. Hansch, C., Bjorkroth, J. P., and Leo, A. Hydrophobicity and central nervous system agents: On the principle of minimal hydrophobicity in drug design. *J. Pharm. Sci.* 76:683–686, 1987.
83. Pardridge, W. M. CNS drug design based in principles of blood–brain barrier transport. *J. Neurochem.* 70:1781–1792, 1998.
84. George, A. The design and molecular modeling of CNS drugs. *Curr. Opin. Drug Disc. Dev.* 2:286–292, 1999.
85. Levin, V. Relationship of octanol/water partition coefficient and molecular weight to rat brain capillary permeability. *J. Med. Chem.* 23:682–684, 1980.
86. Young, R. C., Mitchell, R. C., Brown, T. H., Ganellin, C. R., Griffiths, R., Jones, M., Rana, K. K., Saunders, D., Smith, I. R., Sore, N. E., and Wilks, T. J. Development of a new physico-chemical model for brain penetration and its application to the design of centrally acting H₂ receptor histamine antagonists. *J. Med. Chem.* 31:656–671, 1988.
87. van de Waterbeemd, H. and Kansy, M. Hydrogen bonding capacity and brain penetration. *Chimia* 46:299–303, 1992.
88. Abraham, M. H., Chadha, H. S., and Mitchell, R. C. Hydrogen bonding. Part 33. Factors that influence the distribution of solutes between blood and brain. *J. Pharm. Sci.* 83:1257–1268, 1994.
89. Abraham, M. H., Chadha, H. S., and Mitchell, R. C. Hydrogen-bonding. Part 36. Determination of blood brain distribution using octanol–water partition coefficients. *Drug Design Disc.* 13:123–131, 1995.
90. Lombardo, F., Blake, J. F., and Curatolo, W. J. Computation of brain–blood partitioning of organic solutes via free energy calculations. *J. Med. Chem.* 39:4750–4755, 1996.
91. Norinder, U., Sjöberg, P., and Osterberg, T. Theoretical calculation and prediction of brain–blood partitioning of organic solutes using MolSurf parametrization and PLS statistics. *J. Pharm. Sci.* 87:952–959, 1998.
92. Luco, J. M. Prediction of the brain–blood distribution of a large set of drugs from structurally derived descriptors using partial least squares (PLS) modeling. *J. Chem. Inf. Comput. Sci.* 39:396–404, 1999.

93. Clark, D. E. Rapid calculation of polar molecular surface area and its application to the prediction of transport phenomena. 2. Prediction of blood-brain barrier penetration. *J. Pharm. Sci.* 88:815–821, 1999.
94. Kelder, J., Grootenhuis, P. D. J., Bayada, D. M., Delbressine, L. P. C., and Ploemen, J. Polar molecular surface as a dominating determinant for oral absorption and brain penetration of drugs. *Pharm. Res.* 16:1514–1519, 1999.
95. Vallner, J. J. Binding of drugs by albumin and plasma protein. *J. Pharm. Sci.* 66:447–465, 1977.
96. Øie, S. Drug distribution and binding. *J. Clin. Pharmacol.* 26:586–586, 1986.
97. Rowley, M., Kulagowski, J. J., Watt, A. P., Rathbone, D., Stevenson, G. I., Carling, R. W., Baker, R., Marshall, G. R., Kemp, J. A., Foster, A. C., Grimwood, S., Hargreaves, R., Hurley, C., Saywell, K. L., Tricklebank, M. D., and Leeson, P. D. Effect of plasma protein binding on *in vivo* activity and brain penetration of glycine/NMDA receptor antagonists. *J. Med. Chem.* 40:4053–4068, 1997.
98. Moriguchi, I. Protein binding II. Binding of aromatic carboxylic acids to bovine serum albumin. *Chem. Pharm. Bull.* 16:597–600, 1968.
99. Biagi, G. L., Barbaro, A. M., Gandolfi, O., Guerra, M. C., and Cantelli-Forti, G. R. Values of steroids as an expression of their lipophilic character in structure-activity studies. *J. Med. Chem.* 18:873–883, 1975.
100. Jusko, W. J. and Gretch, M. Plasma and tissue protein binding of drugs in pharmacokinetics. *Drug Metab. Rev.* 5:43–140, 1976.
101. Seydel, J. K. and Schaper, K.-J. Quantitative structure-pharmacokinetic relationships and drug design. *Pharmacol. Ther.* 15:131–182, 1982.
102. Ritschel, W. A. and Hammer, G. V. Prediction of the volume of distribution from *in vitro* data and use for estimating the absolute extent of absorption. *Int. J. Clin. Pharmacol., Ther. Toxicol.* 18:298–314, 1980.
103. Toon, S. and Rowland, M. Structure-pharmacokinetic relationships among the barbiturates in the rat. *J. Pharmacol. Exp. Ther.* 225:752–763, 1983.
104. Anton Fos, G. M., Garcia Domenech, R., Perez Gimenez, F., Galvez Alvarez, J., Garcia March, E., Soler Roca, R. M., and Salabert Salvador, M. T. Estudios de prediccion de propiedades farmacocineticas de hipoglucemiantes orales utilizando relaciones Q.S.A.R. *An. Real. Acad. Farm.* 58:551–562, 1992.
105. Herman, R. A. and Veng-Pedersen, P. Quantitative structure-pharmacokinetic relationships for systemic drug distribution kinetics not confined to a congeneric series. *J. Pharm. Sci.* 83:423–428, 1994.
106. Hirono, S., Nakagome, I., Hirano, H., Yoshii, F., and Moriguchi, I. Noncongeneric structure-pharmacokinetic property correlation studies using fuzzy adaptive least-squares: Volume of distribution. *Biol. Pharm. Bull.* 17:686–690, 1994.
107. Moriguchi, I. Fuzzy adaptive least-squares and its use in QSAR. In *Computer Aided Innovation of New Materials II. Proceedings of the International Conference on Exhibited and Computed Applied Materials, Molecular Science, and Engineering* (M. Doyama, J. Kihara, M. Tanaka, and R. Yamamoto, Eds.), 2nd ed., pp. 1121–1126. North-Holland, Amsterdam, 1993.
108. Lázníček, M. and Lázníčková, A. The effect of lipophilicity on the protein binding and blood cell uptake of some acidic drugs. *J. Pharm. Biomed. Anal.* 13:823–828, 1995.
109. Smith, D. R. Physicochemical properties in drug metabolism and pharmacokinetics. In *Proceedings of the 11th European Symposium on Quantitative Structure-Activity Relationships* (H. van de Waterbeemd, B. Testa, and G. Folkers, Eds.), pp. 267–276. Verlag Helvetica Chimica Acta, Basel, 1997.
110. Smith, D. A., Ackland, M. J., and Jones, B. C. Properties of cytochrome P450 isoenzymes and their substrates. Part 1: Active site characteristics. *Drug Discovery Today* 2:406–414, 1997.
111. Smith, D. A., Ackland, M. J., and Jones, B. C. Properties of cytochrome P450 isoenzymes and their substrates. Part 2: Properties of cytochrome P450 substrates. *Drug Discovery Today* 2:479–486, 1997.
112. Ekins, S., Ring, B. J., Bravi, G., Wikel, J. H., and Wrighton, S. A. Predicting drug-drug interactions *in silico* using pharmacophores: A paradigm for the next millenium. In *Pharma-*

- cophore Perception, Development, and Use in Drug Design* (O. F. Güner, Ed.), pp. 269–299. International University Line, La Jolla, CA, 2000.
113. Lewis, D. F. V. In *Proceedings of the 11th European Symposium on Quantitative Structure–Activity Relationships* (H. van de Waterbeemd, B. Testa, and G. Folkers, Eds.), pp. 335–354. Verlag Helvetica Chimica Acta, Basel, 1997.
 114. Strobl, G. R., von Kruedener, S., Stöckigt, J., Guengerich, F. P., and Wolff, T. Development of a pharmacophore for inhibition of human liver cytochrome P-450 2D6: Molecular modeling and inhibition studies. *J. Med. Chem.* 36:1136–1145, 1993.
 115. Ekins, S., Bravi, G., Binkley, S., Gillespie, J. S., Ring, B. J., Wikel, J. H., and Wrighton, S. A. Three and four dimensional-quantitative structure activity relationship (3D/4D-QSAR) analyses of CYP2D6 inhibitors. *Pharmacogenetics* 9:477–489, 1999.
 116. de Groot, M. J., Ackland, M. J., Horne, V. A., Alex, A. A., and Jones, B. C. Novel approach to predicting P450-mediated drug metabolism: Development of a combined protein and pharmacophore model for CYP2D6. *J. Med. Chem.* 42:1515–1524, 1999.
 117. de Groot, M. J., Ackland, M. J., Horne, V. A., Alex, A. A., and Jones, B. C. A novel approach to predicting P450 mediated drug metabolism. CYP2D6 catalyzed N-dealkylation reactions and qualitative metabolite predictions using a combined protein and pharmacophore model for CYP2D6. *J. Med. Chem.* 42:4062–4070, 1999.
 118. Ekins, S., Bravi, G., Binkley, S., Gillespie, J. S., Ring, B. J., Wikel, J. H., and Wrighton, S. A. Three- and four-dimensional quantitative structure activity relationship analyses of cytochrome P-450 3A4 inhibitors. *J. Pharmacol. Exp. Ther.* 290:429–438, 1999.
 119. Ekins, S., Bravi, G., Wikel, J. H., and Wrighton, S. A. Three-dimensional-quantitative structure activity relationship analysis of cytochrome P-450 3A4 substrates. *J. Pharmacol. Exp. Ther.* 291:424–433, 1999.
 120. Fuhr, U., Strobl, G., Manaut, F., Anders, E., Sörgel, F., Lopez de Brinas, E., Chu, D. T. W., Pernet, A. G., Mahr, G., Sanz, F., and Staib, A. H. Quinolone antibacterial agents: Relationship between structure and in vitro inhibition of the human cytochrome P450 isoform CYP1A2. *Mol. Pharmacol.* 43:191–199, 1993.
 121. Ekins, S., Bravi, G., Ring, B. J., Gillespie, T. A., Gillespie, J. S., Vandenbranden, M., Wrighton, S. A., and Wikel, J. H. Three-dimensional quantitative structure activity relationship analyses of substrates for CYP2B6. *J. Pharmacol. Exp. Ther.* 288:21–29, 1999.
 122. Jones, J. P., He, M., Trager, W. F., and Rettie, A. Three-dimensional quantitative structure–activity relationship for inhibitors of cytochrome P4502C9. *Drug Metab. Dispos.* 24:1–6, 1996.
 123. Rao, S., Aoyama, R., Schrag, M., Trager, W. F., Rettie, A., and Jones, J. P. A refined 3-dimensional QSAR of cytochrome P450 2C9: Computational predictions of drug interactions. *J. Med. Chem.* 43:2789–2796, 2000.
 124. Kim, K. H. Quantitative structure–activity relationships of the metabolism of drugs by uridine diphosphonate glucuronosyltransferase. *J. Pharm. Sci.* 80:966–970, 1991.
 125. Holmes, E., Sweatman, B. C., Bollard, M. E., Blackledge, C. A., Beddell, C. R., Wilson, I. D., Lindon, J. C., and Nicholson, J. K. Prediction of urinary sulphate and glucuronide conjugate excretion for substituted phenols in the rat using quantitative structure–metabolism relationships. *Xenobiotica* 25:1269–1281, 1995.
 126. Cupid, B. C., Beddell, C. R., Lindon, J. C., Wilson, I. D., and Nicholson, J. K. Quantitative structure–metabolism relationships for substituted benzoic acids in the rabbit: Prediction of urinary excretion of glycine and glucuronide conjugates. *Xenobiotica* 26:157–176, 1996.
 127. Hawkins, D. R. Use and value of metabolism databases. *Drug Discovery Today* 4:466–471, 1999.
 128. Klopman, G., Dimayuga, M., and Talafous, J. META. 1. A program for the evaluation of metabolic transformation of chemicals. *J. Chem. Inf. Comput. Sci.* 34:1320–1325, 1994.
 129. Talafous, J., Sayre, L. M., Mieyal, J. J., and Klopman, G. META. 2. A dictionary model of mammalian xenobiotic metabolism. *J. Chem. Inf. Comput. Sci.* 34:1326–1333, 1994.
 130. Klopman, G., Tu, M., and Talafous, J. META. 3. A genetic algorithm for metabolic transform priorities optimization. *J. Chem. Inf. Comput. Sci.* 37:329–334, 1997.
 131. Klopman, G., Tu, M., and Fan, B. T. META. 4. Prediction of the metabolism of polycyclic aromatic hydrocarbons. *Theor. Chem. Acc.* 102:33–38, 1999.
 132. Smith, R. L. *The Excretory Function of Bile*. Chapman & Hall, London, 1973.

133. Hirom, P. C., Millburn, P., Smith, R. L., and Williams, R. T. Species variations in the threshold molecular-weight factor for the biliary excretion of organic anions. *Biochem. J.* 129:1071–1077, 1972.
134. Cantelli-Forti, G., Guerra, M. C., Barbaro, A. M., Hrelia, P., Biagi, G. L., and Borea, P. A. Relationship between lipophilic character and urinary excretion of nitroimidazoles and nitrothiazoles in rats. *J. Med. Chem.* 29:555–561, 1986.
135. Fleck, C. and Braunlich, H. Factors determining the relationship between renal and hepatic excretion of xenobiotics. *Arzneim.-Forsch.* 40:942–946, 1990.
136. Shargel, L. and Yu, A. B. C. *Applied Biopharmaceutics and Pharmacokinetics*, 4th ed. Appleton & Lange, Stamford, CT, 1999.
137. Hamilton, H. W., Steinbaugh, B. A., Stewart, B. H., Chan, O. H., Schmid, H. L., Schroeder, R., Ryan, M. J., Keiser, J., Taylor, M. D., Blankley, C. J., Kaltenbronn, J. S., Wright, J., and Hicks, J. Evaluation of physicochemical parameters important to the oral bioavailability of peptide-like compounds: Implications for the synthesis of renin inhibitors. *J. Med. Chem.* 38:1446–1455, 1995.
138. Pitkin, D. H., Mico, B. A., Sitrin, R. D., and Nisbet, L. J. Charge and lipophilicity govern the pharmacokinetics of glycopeptide antibiotics. *Antimicrob. Agents Chemother.* 29:440–444, 1986.
139. Yamada, T. (R&D Chairman, SmithKline Beecham). *The Pink Sheet—News from Europe* Jan. 24, 2000.
140. Fisher, R. A. *Statistical Methods for Research Workers*. Oliver & Boyd, London, 1925; *The Design of Experiments*. Oliver & Boyd, London, 1935.
141. Hunter, J. S. Applying statistics to solving chemical problems. *CHEMTECH* 17:167–169, 1987.
142. Czitrom, V. One-factor-at-a-time versus designed experiments. *Am. Statist.* 53:126–131, 1999.
143. Fecik, R. A., Frank, K. E., Gentry, E. J., Menon, S. R., Mitscher, L. A., and Telikepalli, H. The search for orally active medications through combinatorial chemistry. *Med. Res. Rev.* 18:149–185, 1998.
144. Bohacek, R. S., McMartin, C., and Guida, W. C. The art and practice of structure-based drug design: A molecular modeling perspective. *Med. Res. Rev.* 16:3–50, 1996.
145. Walters, W. P., Stahl, M. T., and Murcko, M. A. Virtual screening—An overview. *Drug Discovery Today* 3:160–178, 1998.
146. Brennan, M. Drug discovery. Filtering out failures early in the game. *Chem. Eng. News* 78(23):63–73, 2000.
147. Bures, M. G. and Martin, Y. C. Computational methods in molecular diversity and combinatorial chemistry. *Curr. Opin. Chem. Biol.* 2:376–380, 1998.
148. Spellmeyer, D. C. and Grootenhuis, P. D. J. Recent developments in molecular diversity. Computational approaches to combinatorial chemistry. *Annu. Rep. Med. Chem.* 34:287–296, 1999.
149. Mason, J. S. and Hermsmeier, M. A. Diversity assessment. *Curr. Opin. Chem. Biol.* 3:342–349, 1999.
150. Hassan, M., Bielawski, J. P., Hempel, J. C., and Waldman, M. Optimization and visualization of molecular diversity of combinatorial libraries. *Mol. Diversity* 2:64–74, 1996.
151. Brown, R. D. and Martin, Y. C. Designing combinatorial library mixtures using a genetic algorithm. *J. Med. Chem.* 40:2304–2313, 1997.
152. Martin, E. J. and Critchlow, R. E. Beyond mere diversity: Tailoring combinatorial libraries for drug discovery. *J. Comb. Chem.* 1:32–45, 1999.
153. Gillet, V. J., Willett, P., Bradshaw, J., and Green, D. V. S. Selecting combinatorial libraries to optimize diversity and physical properties. *J. Chem. Inf. Comput. Sci.* 39:169–177, 1999.
154. Koehler, R. T., Dixon, S. L., and Villar, H. O. LASSOO: A generalized directed diversity approach to the design and enrichment of chemical libraries. *J. Med. Chem.* 42:4695–4704, 1999.
155. Jamois, E. A., Hassan, M., and Waldman, M. Evaluation of reagent-based and product-based strategies in the design of combinatorial library subsets. *J. Chem. Inf. Comput. Sci.* 40:63–70, 2000.

156. Gillet, V. J., Willett, P., and Bradshaw, J. The effectiveness of reactant pools for generating structurally-diverse combinatorial libraries. *J. Chem. Inf. Comput. Sci.* 37:731–740, 1997.
157. Ajay, Bemis, G. W., and Murcko, M. A. Designing libraries with CNS activity. *J. Med. Chem.* 42:4942–4951, 1999.
158. Martin, E. J., Critchlow, R. E., Spellmeyer, D. C., Rosenberg, S., Spear, K. L., and Blaney, J. M. Diverse approaches to combinatorial library design. *Pharmacochem. Library* 29:133–146, 1998.
159. Pickett, S. D., McLay, I. M., and Clark, D. E. Enhancing the hit-to-lead properties of lead optimization libraries. *J. Chem. Inf. Comput. Sci.* 40:263–272, 2000.
160. Egan, W. J., Merz, K. M., and Baldwin, J. J. Qualitative prediction of drug absorption using multivariate statistics. Unpublished. *J. Med. Chem.* 43:3867–3877, 2000.
161. Johnson, D. The discovery–development interface has become the new interfacial phenomenon. *Drug Discovery Today* 4:535–536, 1999.
162. Stevens, M. E., Bouchard, P. J., Kariv, I., Chung, T. D., and Oldenburg, K. R. Comparison of automation equipment in high-throughput screening. *J. Biomol. Screening* 3:305–311, 1998.
163. Dunn, D., Orłowski, M., McCoy, P., Gastgeb, F., Appell, K., Ozgur, L., Webb, M., and Burbaum, J. Ultra-high throughput screen of two-million-member combinatorial compound collection in a miniaturized, 1536-well format. *J. Biomol. Screening* 5:177–187, 2000.
164. Wang, G. T., Matayoshi, E., Huffaker, J. E., and Krafft, G. A. Design and synthesis of new fluorogenic HIV protease substrates based on resonance energy transfer. *Tetrahedron Lett.* 31:6493–6496, 1991.
165. Burbaum, J. J. Miniaturization technologies in HTS: How fast, how small how soon? *Drug Discovery Today* 3:313–322, 1998.
166. Earnshaw, D. L., Moore, K. J., Greenwood, C. J., Djaballah, H., Jurewicz, A. J., Murray, K. J., and Pope, A. J. Time-resolved fluorescence energy transfer DNA helicase assays for high-throughput screening. *J. Biomol. Screening* 4:239–248, 1999.
167. Wu, J., Yarwood, D. R., Pham, Q., and Sills, M. A. Identification of a high-affinity anti-phosphoserine antibody for the development of a homogeneous fluorescence polarization assay of protein kinase C. *J. Biomol. Screening* 5:23–30, 2000.
168. Levine, L. M., Michener, M. L., Toth, M. V., and Holwerda, B. C. Measurement of specific protease activity utilizing fluorescence polarization. *Anal. Biochem.* 247:83–88, 1997.
169. Banks, P., Gosselin, M., and Prystay, L. Fluorescence polarization assays for high-throughput screening of G protein-coupled receptors. *J. Biomol. Screening* 5:159–167, 2000.
170. Miraglia, S., Swartzman, E. E., Mellentin-Michelotti, J., Evangelista, L., Smith, C., Gunawan, I., Lohman, K., Goldberg, E. M., Manian, B., and Yuan, P. Homogeneous cell- and bead-based assays for high-throughput screening using fluorometric microvolume assay technology. *J. Biomol. Screening* 4:193–204, 1999.
171. Ohlmeyer, M. H. J., Swanson, R. N., Dillard, L. W., Reader, J. C., Asouline, G., Kobayashi, R., Wigler, M., and Still, W. C. Complex synthetic chemical libraries indexed with molecular tags. *Proc. Natl. Acad. Sci. U.S.A.* 90:10,922–10,926, 1993.
172. Nestler, H. P., Bartlett, P. A., and Still, W. C. A general method for molecular tagging of encoded combinatorial chemistry libraries. *J. Org. Chem.* 59:4723–4724, 1994.
173. Horlick R. A., Ohlmeyer, M. H., Stroke, I. L., Strohl, B., Pan, G., Schilling, A. E., Paradar, V., Quintero, J. G., You, M., Riviello, C., Thorn, M. B., Damaj, B., Fitzpatrick, V. D., Dolle, R. E., Webb, M. L., Baldwin, J. J., and Sigal, N. H. Small molecule antagonists of the bradykinin B1 receptor. *Immunopharmacology* 43:169–177, 1999.

3

SOLID-STATE ANALYSIS

HARRY G. BRITTAIN

Center for Pharmaceutical Physics, Milford, New Jersey 08848-1930

- I. INTRODUCTION
- II. PROPERTIES ASSOCIATED WITH THE MOLECULAR LEVEL
 - A. Ultraviolet/Visible Diffuse Reflectance Spectroscopy
 - B. Vibrational Spectroscopy
 - C. Nuclear Magnetic Resonance Spectrometry
- III. PROPERTIES ASSOCIATED WITH THE PARTICULATE LEVEL
 - A. Microscopy
 - B. X-Ray Diffraction
 - C. Thermal Methods of Analysis
- IV. PROPERTIES ASSOCIATED WITH THE BULK LEVEL
 - A. Particle Size Distribution
 - B. Micromeritics
 - C. Powder Characterization
- V. SUMMARY
- REFERENCES

I. INTRODUCTION

The normal route of administration for most pharmaceutically active agents is through the use of solid dosage forms,¹ and these units are ordinarily produced by the formulation and processing of powdered solids.² Until fairly recently, the priority of regulatory bodies has always focused on concerns of safety and efficacy, which led to an overwhelming emphasis on aspects of chemical purity. This situation has changed drastically over the past decade, with an ever-increasing degree of attention being given to the physical properties of the solids that compromise a dosage form.³ Ignoring the physical aspects of a formulation can be disastrous, because a variety of solid-state reactions can compromise the stability of a drug entity in its tablet matrix.^{1,4} Often the pathways of these reactions can be dramatically different compared with how the same reaction proceeds in the liquid or gaseous phase.⁵

The acquisition of a sufficiently detailed body of physical information can allow a formulator to transcend an ability to cope with unanticipated crises. For a well-understood system, it is theoretically possible to design an automated or semiautomated manufacturing scheme for which the processing variables are appropriately controlled and the possibility of batch failure is, hence, minimized. Materials that pass the hurdles of physical test specifications would perform predictably and could, therefore, be blended, granulated, dried, compressed, and delivered into containers without operator intervention. It is presently recognized that to avoid problems during drug development, the physical characterization of bulk drugs, excipients, and blends of them should

become part of the normal process. The degree of physical testing necessarily will vary with the particular formulation, but should include any and all test methods deemed appropriate.

A systematic approach to the physical characterization of pharmaceutical solids has been outlined^{3,6} and serves as a useful pedagogical device for the classification of the many methods of physical characterization available. Within this system, physical properties are classified as being associated with the *molecular* level (those associated with individual molecules), the *particulate* level (those pertaining to individual solid particles), or the *bulk* level (those associated with an assembly of particulate species).

One of the areas where the physical characterization of solids has become extremely important is the study of polymorphs and solvatomorphs. The nature of the crystal structure adopted by a given compound upon crystallization exerts a profound effect on the solid-state properties of that system, and that these variations can translate into significant differences in properties is of pharmaceutical importance. It is now accepted that an evaluation of the polymorphism available to a drug substance must be thoroughly investigated early during the stages of development. The results of these studies must be included in the chemistry, manufacturing, and control section of a new drug application, and such information is required to demonstrate control over the manufacturing process.

II. PROPERTIES ASSOCIATED WITH THE MOLECULAR LEVEL

Molecular properties may be defined as those material characteristics that theoretically can be measured for a small ensemble of individual molecules. Due to the minimal sample requirements, molecular properties are often determined at the earliest stages of drug development. Most of the molecular level techniques are spectroscopic in nature, but insofar as they are influenced by the physical state of the substance, substantial information of great use to formulators can be obtained from appropriately designed experiments. For example, a screening of stressed materials can be carried out on the microgram level using infrared microscopy,⁷ and the results of such work aid the preformulation characterization of a new chemical entity.

A. Ultraviolet/Visible Diffuse Reflectance Spectroscopy

With the exception of single-crystal transmission work, most solids are too opaque to permit the conventional use of ultraviolet/visible (UV/VIS) electronic spectroscopy. As a result, such work must be performed using diffuse reflection techniques.⁸⁻¹⁰ Studies have been conducted where UV/VIS spectroscopy was used to study the reaction pathways of various solid-state reactions. Other applications have been made in the fields of color measurement and color matching, areas that can be of considerable importance when applied to the coloring agents used in formulations.

It was recognized some time ago that diffuse reflectance spectroscopy is a very useful tool for the study of interactions among various formulation components, and the technique has been successfully used in the characterization

of many solid-state reactions.¹¹ Investigations conducted under appropriately designed stress conditions have been useful in the study of drug-excipient interactions, drug degradation pathways, and alterations in bioavailability owing to chemisorption of the drug onto other components in the formulation.

Jozwiakowski and Connors¹² used diffuse reflectance spectroscopy to study the adsorption of spiropyran onto pharmaceutically relevant solids. The particular adsorbants studied were interesting in that the spectral characteristics of the binary system depended strongly on the amount of material bound. At low concentrations, the pyran sorbent exhibited its main absorption band around 550 nm. As the degree of coverage was increased, the 550-nm band was still observed, but a much more intense absorption band at 470 nm became prominent. This secondary effect was attributed to the presence of pyran-pyran interactions, which became more important as the concentration of sorbent increased.

The perception of color is subjectively developed in the mind of an individual and, consequently, different people can perceive a given color in various ways. Such variability in interpretation causes great difficulty in the evaluation of color-related phenomena, leading to problems in making objective judgments. The development of quantitative methods for color determination was undertaken to eliminate the subjectivity associated with visual interpretative measurements.

The most successful quantitative expression of color is that known as the Commission Internationale de l'Éclairage (CIE) system.¹³ This methodology assumes that color can be expressed as the summation of selected spectral components (blue, green, and red hues) in a three-dimensional manner. The CIE system is based on the fact that human sight is trichromatic in its color perception and that two stimuli will produce the same color if each of the three tristimulus values (X , Y , and Z) is equal for the two. Detailed summaries of the CIE and other quantitative systems for color measurement are available.^{14, 15}

In a recent application, the appearance testing of tablets through measurement of color changes was automated using fiber optic probes and factor analysis of the data.¹⁶ Good correlation between measured chromaticity parameters and visual subjective judgment was demonstrated, with samples of differing degrees of whiteness being used to develop the correlation. The methodology was complicated because surface defects on the analyzed materials can compromise the quality of the correlation.

B. Vibrational Spectroscopy

The energies associated with the fundamental vibrational modes of a chemical compound lie within the range of 400–4000 cm^{-1} , a spectral region that corresponds to mid-infrared electromagnetic radiation. Transitions among vibrational energy levels can be observed directly through their absorbance in the infrared region of the spectrum; Fourier-transform infrared spectroscopy (FTIR) is now the method of choice. In addition, these transitions also can be observed using Raman spectroscopy, where the inelastic scattering of incident energy is used to obtain vibrational spectra. Overtones and combination bands

of vibrational modes are observed in the near-infrared region of the spectrum ($4000\text{--}13,350\text{ cm}^{-1}$).

Infrared (IR) absorption spectroscopy, especially measured by FTIR, is a powerful technique for the physical characterization of pharmaceutical solids.¹⁷ When the structural characteristics of a solid perturb the pattern of vibrational motion for a given molecule, these alterations can be used as a means to study the solid-state chemistry of the system. FTIR spectra often are used to evaluate the type of polymorphism that exists in a drug substance and can be very useful to study the water contained within hydrate species. Solid-state IR absorption spectra often are obtained on powdered solids through the combined use of FTIR and diffuse reflectance detection, and interpreted through conventional group frequency compilations.¹⁸

When the vibrational modes of a compound are affected by fine details of molecular structure (i.e., polymorphism), the diffuse reflectance IR spectra of the polymorphs can be used to study this behavior. For example, glisentide has been obtained in a number of polymorphic and solvatomorphic forms, with the anhydrous forms I and II exhibiting large differences in infrared spectra.¹⁹ The IR spectra of forms I and II are shown in Figure 1, where it can be noted that two bands assigned to the urea carbonyl group are found at 1635 and 1545 cm^{-1} in form I and at 1620 and 1545 cm^{-1} in form II. In addition, the shoulder that is present in both forms is more intense in the spectrum of form II. The S=O stretching band is observed at 1157 cm^{-1} in the spectrum of form I, but for form II it shifts to 1165 cm^{-1} . Another observation is that the aromatic carbonyl group at 1720 cm^{-1} is present in both spectra, but is broadened in the case of form II. It ultimately was deduced that the polymorphism of glisentide probably is due to changes in crystal packing rather than conformational differences.

Another technique of vibrational spectroscopy that is ideally suited for characterization of solids is Raman spectroscopy. In this methodology, the sample is irradiated with monochromatic laser radiation, and the inelastic scattering of the source energy is used to obtain a vibrational spectrum of the analyte.²⁰ Because most compounds of pharmaceutical interest are of low sym-

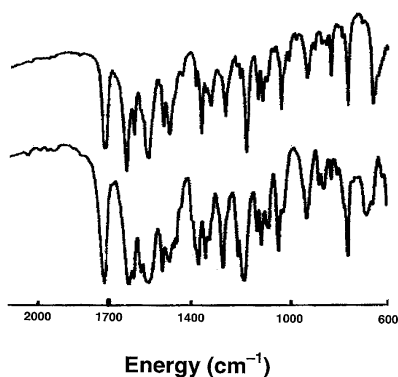

FIGURE 1 Infrared absorption spectra of glisentide: upper trace, form I; lower trace, form II. The data were adapted from reference 19.

metry, the Raman spectrum generally resembles the spectrum obtained using the FTIR method. Owing to the fundamentally different selection rules associated with the phenomenon, differences in peak intensity are often observed. In general, symmetric vibrations and nonpolar groups yield the most intense Raman scattering bands, whereas antisymmetric vibrations and polar groups yield the most intense infrared absorption bands.

For instance, Raman spectroscopy was used to study the effect of pressure and temperature on the phase composition of fluoranil crystals.²¹ Figure 2 shows the Raman spectra obtained at a series of increasing pressures, where the changes in band frequency indicate the existence of pressure-induced phase transitions. It was deduced from sharp discontinuities in the Raman spectra that a phase transition took place at a temperature of around 180 K if the pressure was 1 atm, but that this transition shifted to 300 K if the pressure was increased to 0.8 GPa. Other work indicates that this particular phase transition does not entail a change in the crystal space group, but involves displacement within the unit cell.

A broad range of applications is possible when using near-IR spectroscopy, but the nature of the problems ordinarily addressed by this methodology is somewhat different than those just described.²² Near-IR spectra consist of overtone transitions of fundamental vibrational modes and are not, therefore, generally useful for identity purposes without the use of multicomponent analysis. The spectral features are of greatest utility in the detection and determination of functional groups that contain unique hydrogen atoms. For example, studies of water in solids can be easily performed through systematic characterization of the characteristic —OH band, usually observed around 5170 cm^{-1} . The determination of hydrate species in an anhydrous matrix can be performed easily using near-IR analysis.

The near-IR technique has been used very successfully for moisture determination, whole tablet assay, and blending validation.²³ These methods are typically easy to develop and validate and far easier to run than more traditional assay methods. It is possible to use the overtone and combination bands

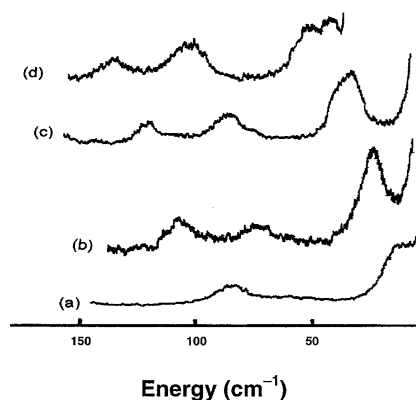

FIGURE 2 Raman spectra obtained at 300 K for crystalline fluoranil at pressures of (a) 1 atm, (b) 0.5 GPa, (c) 1.4 GPa, and (d) 2.4 GPa. The data were adapted from reference 21.

of water to develop near-IR methods that have accuracy equivalent to that obtained using Karl–Fischer titration. The distinction among tablets of differing potencies is performed very easily and, unlike high-performance liquid chromatography (HPLC) methods, does not require destruction of the analyte materials to obtain a result.

C. Magnetic Resonance Spectrometry

The ultimate molecular level characterization of a pharmaceutical material is performed on the level of individual chemical environments of each atom in the compound, and this information is best obtained using nuclear magnetic resonance (NMR) spectroscopy. Advances in instrumentation and computer pulse sequences currently allow these studies to be carried out routinely in the solid state.²⁴ Although any nucleus that can be studied in the solution phase also can be studied in the solid state, most work has focused on ¹³C studies. ¹H-NMR remains an extremely difficult measurement in the solid state, and the data obtained from such work can be obtained only at medium resolution. The main problem is that ¹H-NMR has one of the smallest isotropic chemical shift ranges (12 ppm), but has peak broadening effects that can span several parts per million in magnitude.

The local magnetic field (B_{loc}) at a ¹³C nucleus in an organic solid is given by

$$B_{\text{loc}} = \pm \{h\gamma_H/4\pi\} \{(3 \cos^2 \theta - 1)/r^3\}$$

where γ_H is the magnetogyric ratio of the protons, r is the internuclear C-H distance to the bonded proton, and θ is the angle between the C–H bond and the external applied field (B_0). The plus/minus (\pm) sign results from the fact that the local field may add to or subtract from the applied field, depending on whether the neighboring proton dipole is aligned with or against the direction of B_0 . In a microcrystalline organic solid, there is a summation over many values of θ and r that results in a proton dipolar broadening of many kilohertz. A rapid reorientation of the C-H internuclear vectors (such as those associated with the random molecular motions that take place in the liquid phase) results in reduction of the dipolar broadening. In solids, such rapid isotropic tumbling is not possible, but because the term $(3 \cos^2 \theta - 1)$ equals zero if θ equals $\cos^{-1} 3^{-1/2}$ (approximately $54^\circ 44'$), spinning the sample at the so-called magic angle of $54^\circ 44'$ with respect to direction of the applied magnetic field results in an averaging of the chemical shift anisotropy. In a solid sample, the anisotropy reflects the chemical shift dependence of chemically identical nuclei on their spatial arrangement with respect to the applied field. Whereas this anisotropy is primarily responsible for the spectral broadening associated with ¹³C samples, spinning at the magic angle makes it possible to obtain high-resolution ¹³C-NMR spectra of solid materials.

An additional method for removal of ¹³C-¹H dipolar broadening is to use a high-power proton decoupling field, often referred to as dipolar decoupling. This method involves irradiation of the sample using high power at an appropriate frequency, which results in the complete collapse of all ¹³C-¹H couplings. With proton dipolar coupling alone, the resonances in a typical

solid-state ^{13}C spectrum remain very broad (on the order of 10–200 ppm). This broadening arises from the fact that the chemical shift of a particular carbon is directional, depending on the orientation of the molecule with respect to the magnetic field.

Even though high-resolution spectra can be obtained on solids using the magic angle spinning (MAS) technique, the data acquisition time is lengthy due to the low sensitivity of the nuclei and the long relaxation times exhibited by the nuclei. This problem is circumvented using cross polarization (CP), where spin polarization is transferred from the high-abundance, high-frequency nucleus (^1H) to the rare, low-frequency nucleus (^{13}C). This process results in up to a fourfold enhancement of the normal ^{13}C magnetization, and permits a shortening of the waiting periods between pulses. The CP experiment also allows the measurement of several relaxation parameters that can be used to study the dynamic properties of the solid under investigation.

When the crystallography of compounds related by polymorphism is such that nuclei in the two structures are magnetically nonequivalent, it follows that the resonances of these nuclei are not equivalent. Whereas it is normally not difficult to assign organic functional groups to observed resonances, solid-state NMR spectra can be used to deduce the nature of polymorphic variations, especially when the polymorphism is conformational in nature. Such information has proven to be extremely valuable during various stages in the development of numerous pharmaceutical substances.²⁵

During the development of fosinopril sodium, a crystal structure was solved for the most stable phase, but no such structure could be obtained for its metastable phase.²⁶ The compound contains three carbonyl groups, and the solid-state ^{13}C -NMR spectra (see Fig. 3) of two of these are effectively equivalent

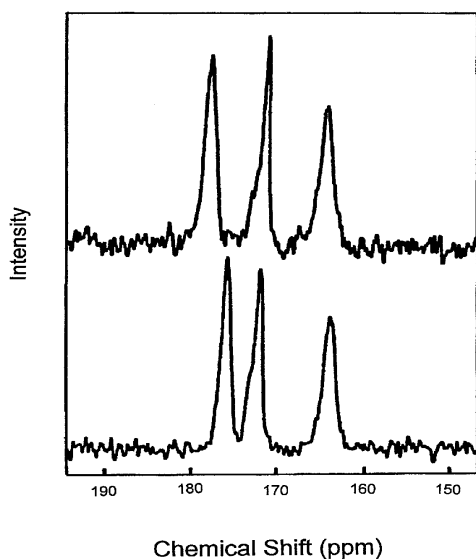

FIGURE 3 Solid-state ^{13}C -NMR spectra obtained within the carbonyl region of fosinopril sodium: upper trace, form A; lower trace, form B. The data were adapted from reference 26.

lent. The third carbonyl, located on the acetal side chain, was found to resonate at different chemical shifts in the two structures. When combined with the observations obtained using vibrational spectroscopy, these results permitted the deduction that the solid-state polymorphism was associated with different conformations of this side chain. The NMR data also suggested that additional conformational differences between the two polymorphs were associated with cis–trans isomerization along the peptide bond, which in turn results in the presence of nonequivalent molecules existing in the unit cell. In the absence of solved crystal structures for the two polymorphs, this information would not have been otherwise obtainable.

The solid-state ^{13}C -NMR spectra of the two polymorphs of furosemide revealed the existence of altered chemical shifts and peak splitting patterns indicative of differences in molecular conformations.²⁷ In this work, studies of $T_{1\rho}$ relaxation times were used to show the presence of more molecular mobility and disorder in form II, whereas the structure of form I was judged to be more rigid and uniformly ordered. During a solid-state spectroscopic study of the polymorphs of losartan, it was deduced that the spectral characteristics of form I implied the presence of multiple orientations for the *n*-butyl side chain and the imidazole ring.²⁸ It was also concluded that form II was characterized by a large molecular motion of the *n*-butyl side chain.

Not all polymorphism originates from conformational requirements, and many polymorphic situations exist because of different modes of molecular packing in the solid-state structures. For example, the two polymorphs of enalapril maleate exhibit very similar molecular conformations (as evidenced by the similarity in spectral characteristics), and the observed differences in crystal structure, therefore, are attributed to different modes of crystal packing.²⁹ Sufficient differences in the solid-state ^{13}C -NMR spectra of the four polymorphs of sulfathiazole were observed to enable the use of this technique as an analytical tool, but these differences could not be ascribed to differences in molecular conformations among the polymorphs.³⁰

Solid-state NMR spectroscopy also can be used to study the molecular environments of nuclei because these environments vary in the differing structures associated with solvates and hydrates. One anhydrate (form α) and two polymorphic monohydrate phases (forms β and δ) of testosterone have been crystallographically characterized and the solid-state ^{13}C -NMR spectra have been obtained for each.³¹ The analysis of the spectra was complicated by the observation that many carbons of a given form resonate as doublets, reflecting the situation that more than one molecular type exists within the unit cells. In a subsequent study, solid-state ^{13}C -NMR spectra were obtained on the anhydrate and monohydrate phases of androstanolone (a known metabolite of testosterone).³² The spectra obtained within the aliphatic carbon region for the two forms are shown in Figure 4, where many doublets (arising from incongruences in the unit cell) were found in the anhydrate spectrum. In the monohydrate phase, no such doubling was observed because the two molecules present in the unit cell are related by symmetry and, consequently, are magnetically equivalent.

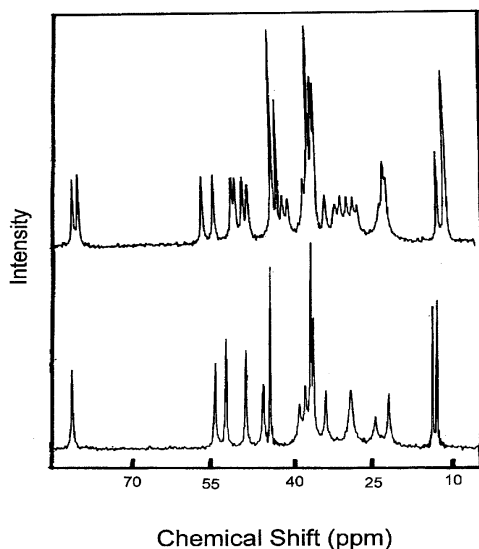

FIGURE 4 Solid-state ^{13}C -NMR spectra obtained within the aliphatic carbon region of the anhydrate (upper trace) and monohydrate (lower trace) forms of androstanolone. The data were adapted from reference 32.

III. PROPERTIES ASSOCIATED WITH THE PARTICULATE LEVEL

Particulate properties are defined as those material characteristics that effectively can be determined by the analysis of a relatively small ensemble of particles. Because the sample requirements for these assay methods are not extravagant, these properties often are also studied during early development once the drug substance is available in at least milligram quantities.

A. Microscopy

Evaluation of the morphology of a pharmaceutical solid is of extreme importance, because this property exerts a significant influence over the micromeritic and bulk powder properties of the material.^{33, 34} Microscopy is also useful as a means to obtain estimations of the particle size distribution in a powdered sample. A determination can be easily made regarding the relative crystallinity of the material, and skilled workers can deduce crystallographic information as well. Unknown particulates often can be identified solely based on their microscopic characteristics, although it is useful to obtain confirmatory support for these conclusions with the aid of microscopically assisted techniques.

Both optical and electron microscopies are widely used to characterize pharmaceutical solids. Optical microscopy is limited to the range of magnification suitable for routine work, that is, an approximate upper limit of $600\times$. However, this magnification limit does not preclude the investigation of most pharmaceutical materials, and the use of polarizing optics introduces a power into the technique that is not available with other methods. Electron microscopy work can be performed at extraordinarily high magnification lev-

els (up to 90,000 \times on most units), and the images that can be obtained contain a considerable degree of three-dimensional information.

The two microscopy methods are complementary in that each can provide information inaccessible to the other. When these techniques are used in conjunction, substantial characterization of a solid material becomes possible. This information can be extremely useful during the early stages of drug development, because normally only a limited amount of the drug candidate is available at that time. Electron microscopy yields excellent topographic and shape information, and is most useful in forensic situations that involve trace evidence characterization and identification. Light microscopy is most useful to obtain information on the internal properties of small particles, fibers, and films. When polarizing optics are used in light microscopy, the optical properties of the crystals under investigation also can be determined.³³ In that case, molecular (rather than elemental) information can be obtained on the analyte. The methodology for microscopic analysis is being standardized by the United States Pharmacopoeia.³⁵

In the study of solids, probably the most useful light microscopy technique involves the use of polarizing optics.³³ The polarizing microscope is essentially a light microscope equipped with a linear polarizer located below the condenser and an additional polarizer mounted on top of the eyepiece. A rotating stage is also found to be very useful, as is the ability to add other optical accessories (such as phase contrast). Polarization optical analysis is based on the action of the analyte crystal on the properties of the transmitted light. This method can yield several directly measured parameters, such as the sign and magnitude of any observed birefringence, the refractive indices associated with each crystal direction, the axis angles, and the relationships among the optical axes.

The refractive index of light passing through an isotropic crystal will be identical along each of the crystal axes and such crystals, therefore, possess *single refraction*. Anisotropic substances will exhibit different refractive indices for light polarized with respect to the crystal axes, thus exhibiting *double refraction*. Crystals within the hexagonal and tetragonal systems possess one isotropic direction and are termed *uniaxial*. Anisotropic crystals that possess two isotropic axes are termed *biaxial* and include all crystals that belong to the orthorhombic, monoclinic, or triclinic systems. Biaxial crystals will exhibit different indices of refraction along each of the crystal axes.

Isotropic samples are characterized by the existence of equivalent crystal axes; therefore, they exhibit *isotropic extinction* and have no effect on the polarized light no matter how the crystal is oriented. When a sample is capable of exhibiting double refraction, the specimen will appear bright against a dark background. For example, when a uniaxial crystal is placed with the unique *c* axis horizontal on the stage, it will be alternately dark and bright as the stage is rotated. Furthermore, the crystal will be completely dark when the *c* axis is parallel to the transmission plane of the polarizer or analyzer. If the crystal has edges or faces parallel to the *c* axis, then it will be extinguished when such an edge or face is parallel to one of the polarizer directions—a condition known as *parallel extinction*. At all intermediate positions, the crystal will appear light and usually colored. A rhombohedral or pyramidal crystal will be extinguished

when the bisector of a silhouette angle is parallel to a polarization direction, and this type of extinction is termed *symmetrical extinction*. For biaxial crystals, similar results are obtained as with uniaxial crystals. The exception to this rule is that in monoclinic and triclinic systems, the polarization directions need not be parallel to faces or to the bisectors of face angles. If the prominent faces or edges of an extinguished crystal are not parallel to the axes of the initial polarizer, the extinction is said to be *oblique*. Knowledge of the type of extinction therefore permits determination of the system to which a given crystal belongs.

The ability to observe optical properties of crystals during heating and cooling processes is termed thermal microscopy, and this can be a profoundly useful technique during the study of polymorphs and solvatomorphs.^{36, 37} Crystal polymorphs ordinarily exhibit different melting points, and the order of the melting points is indicative of the order of stability at the elevated temperature condition. The interconversion of such crystal forms is classified as either *enantiotropic* or *monotropic*, according to whether the transformation of one modification into the other is reversible. Enantiotropic modifications interchange reversibly at the ordinary transition point, and each form is characterized by its own stability range of temperature. Monotropic substances are characterized by the existence of a purely hypothetical transition point, because this point is predicted to be higher in temperature than the melting point of one of the polymorphic forms. Monotropic polymorphs are characterized by the fact that one form is stable at all temperatures below its melting point, whereas the second form is metastable at all temperatures.³⁴

Scanning electron microscopy (SEM) is the technique of choice to obtain information at high magnification levels or when a three-dimensional view of a particle surface is required. A conventional SEM is similar to an inverted light microscopy in that the source lies above the specimen, the interrogating electron beam is focused by a series of lenses, and the image is constructed on the basis of scattered electromagnetic radiation. Samples are usually coated with conductive materials to reduce the deleterious effects of surface charging, although newer systems are not necessarily limited in this regard. SEM analysis is often combined with x-ray analysis, whereby maps of the elemental distribution within a heterogeneous sample may be obtained.

The morphology of excipient materials plays an important role in their physical properties, which in turn affects their application as formulation ingredients. One rather comprehensive study linked morphology and functionality of 14 direct compression excipients, and SEM analysis was the technique employed throughout.³⁸ For instance, croscarmellose is a polymeric substance that is commonly used in solid dose forms as a disintegrant. When the substance is produced as an ensemble of short fibers, improved flowability characteristics and good blending ability are obtained without adversely affecting the disintegrant properties.

In another particularly interesting application, SEM analysis was used to study the growth of carbamazepine crystals on the surface of tablets that had been stored at elevated temperatures.³⁹ This crystal growth was found to take place only when stearic acid was used as the tablet lubricant, and it was shown in this work that the carbamazepine drug substance could dissolve in

the stearic acid. The lubricant provided a mechanism to transport the drug to the tablet surface, where it could crystallize.

B. X-Ray Diffraction

The technique of x-ray diffraction is exceedingly important to pharmaceuticals because it represents the primary method for obtaining fundamental structural information on crystalline substances. For example, it is only by pure coincidence that two compounds form crystals in which the three-dimensional spacing of planes is identical in all directions. One such example is provided by the trihydrate phases of ampicillin and amoxicillin,⁴⁰ but such instances are uncommon. Typical applications of x-ray diffraction methodology include the determination of crystal structures, evaluation of polymorphism and solvate structures, evaluation of degrees of crystallinity, and the study of phase transitions.

Bragg and Bragg⁴¹ explained the diffraction of x-rays by crystals using a model where the atoms of a crystal are regularly arranged in space and where they can be regarded as lying in parallel sheets separated by a definite and defined distance. Then they showed that scattering centers arranged in a plane act like a mirror to x-rays incident on them, so that constructive interference occurs for the direction of specular reflection. Within a given family of planes, defined by a Miller index of (hkl) and where each plane is separated by distance d , each plane produces a specular reflectance of the incident beam. If the incident x-rays are monochromatic (having wavelength equal to λ), then for an arbitrary glancing angle of θ , the reflections from successive planes are out of phase with one another. This yields destructive interference in the scattered beams. However, by varying θ , a set of values for θ can be found so that the path difference between x-rays reflected by successive planes is an integral number (n) of wavelengths and then constructive interference occurs. Ultimately the expression known as Bragg's law, which explains the phenomenon, is obtained.

$$2d \sin \theta = n\lambda$$

Unlike the case of diffraction of light by a ruled grating, the diffraction of x-rays by a crystalline solid leads to the observation of constructive interference (i.e., reflection) that occurs only for the critical Bragg angles. When reflection does occur, it is stated that the plane in question is reflecting in the n th order or that n th order diffraction is observed for that particular crystal plane. Therefore, an x-ray scattering response is observed for every plane defined by a unique Miller index of (hkl) .

The analysis of single-crystal x-ray diffraction data is divided into three parts.^{42, 43} The first of these is the geometrical analysis, where the exact spatial distribution of x-ray reflections is measured and used to compute the size and shape of a unit cell. The second phase entails a study of the intensities of the various reflections, using this information to determine the atomic distribution within the unit cell. Finally, the x-ray diagram is examined to deduce qualitative information about the quality of the crystal or the degree of order within the solid. This latter analysis permits the adoption of certain assumptions that aid in the solution of the crystalline structure.

The phenomenon of x-ray diffraction has found widespread use as a means to determine the structures of single crystals, and it represents the most powerful and direct method for obtaining bond lengths and bond angles for molecules in the solid state. This information is of extreme importance to workers in pharmaceuticals when they encounter the existence of polymorphism (the ability of a molecule to crystallize in more than one structure of the same degree of solvation) or solvatomorphism (the ability of a molecule to crystallize in different structures that in turn differ in their solvation states). Generally, these effects can be explained by invoking one of two possibilities. If the molecule is constrained to exist as a rigid grouping of atoms, these atoms may be stacked in different motifs to occupy the points of different lattices. This type of polymorphism is then attributable to packing phenomena, and so is termed *packing polymorphism*. On the other hand, if the molecule in question is not rigidly constructed and can exist in distinct conformational states, then each of these conformationally distinct modifications may crystallize in its own lattice structure. This latter behavior is termed *conformational polymorphism*.⁴⁴

There is no doubt that single-crystal x-ray diffraction is a powerful technique for the study of polymorphs and solvatomorphs, but it is equally apparent that this methodology is not well suited for routine evaluation of the crystalline state of powdered solids. For such work, x-ray powder diffraction (XRPD) is much more useful.⁴⁵ A powdered sample will present all possible crystal faces at a given interface and the diffraction off this powdered surface will, therefore, provide information on all possible atomic spacings (i.e., defined by the crystal lattice). The powder pattern consists of a series of peaks of varying intensities detected at various scattering angles. These angles and their relative intensities are correlated with computed d spacings to provide a full crystallographic characterization of the powdered sample. After indexing all the scattered bands, it is possible to derive unit cell dimensions and other crystallographic information from a high-resolution powder pattern of the substance.⁴⁶

To measure a powder pattern, a randomly oriented powdered sample is prepared so as to expose all the planes of a sample. The scattering angle is determined by slowly rotating the sample and measuring the angle of diffracted x-rays (typically using a scintillation detector) with respect to the angle of the incident beam. Alternatively, the angle between the sample and the source can be kept fixed, while moving the detector to determine the angles of the scattered radiation. Because the wavelength of the incident beam is known, the spacing between the planes (identified as the d spacings) is calculated using Bragg's law.

A very useful complement to ordinary powder x-ray diffraction is variable temperature x-ray diffraction. In this method, the sample is contained on a stage that can be heated to any desired temperature. This method is extremely useful in the study of thermally induced phenomena, and is seen as a complement to thermal methods of analysis.

It is not practical to summarize here all of the XRPD studies that have been run to characterize polymorphic or solvatomorphic systems (because essentially every study ever conducted makes use of this methodology), so only a

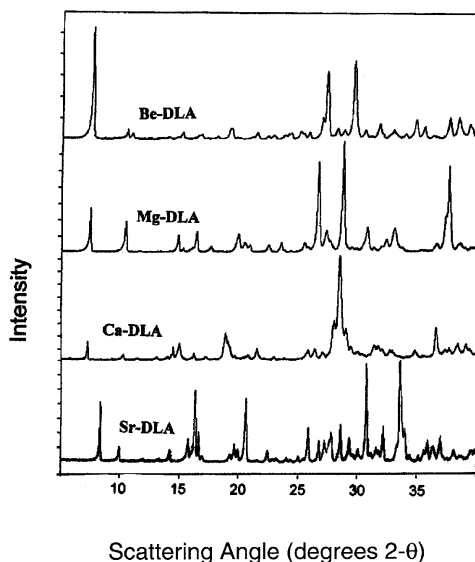

FIGURE 5 X-ray powder diffraction patterns for the alkaline earth cation derivatives of 5-nitrobarbituric acid (dilituric acid). The data were adapted from reference 47.

single example will be cited. Among other uses, 5-nitrobarbituric acid (dilituric acid) has found application as a chemical microscopic reagent for the qualitative identification of alkali metal (group IA) and alkaline earth (group IIA) cations. This methodology is based on the characterization of observed crystal morphologies, because a unique crystal habit can be associated with each adduct product. To understand the scientific foundations that permit chemical microscopy to function as a useful analytical technique, the products formed between dilituric acid and the group IA and IIA cations were characterized using a variety of physical techniques.⁴⁷ It was found that the origins of the different crystal morphologies associated with each of the adducts arose from the ability of the systems to form various hydrate species, which also could contain structural variations due to cation/diliturate packing patterns. As shown in Figure 5, the XRPD patterns obtained for beryllium (a trihydrate phase), magnesium (a 1.5-hydrate phase), calcium (a 0.5-hydrate phase), and strontium (an anhydrate phase) are highly diagnostic of the adduct obtained.

C. Thermal Methods of Analysis

Thermal analysis methods are defined as those techniques in which a property of the analyte is determined as a function of an externally applied temperature.⁴⁸ The sample temperature is increased in a linear fashion, while the property in question is evaluated on a continuous basis. This technology is used to characterize compound purity, polymorphism, solvation, degradation, and excipient compatibility.⁴⁹ Thermal analysis methods are normally used to monitor endothermic processes (melting, boiling, sublimation, vaporization, desolvation, solid-solid phase transitions, and chemical degradation) as well as exothermic processes (crystallization and oxidative decomposition). Access

to this methodology is extremely useful during the conduct of preformulation studies, because carefully planned studies can be used to indicate the existence of possible drug-excipient interactions in a prototype formulation.⁷

Significant insight into the practice of thermal analysis can be gleaned from consideration of the determination of ordinary melting points through the study of fusion curves, for which a typical example is provided in Figure 6. To determine this type of curve, the sample is placed within a suitable container, immersed in a bath whose temperature is increased at a fixed rate, and the temperature of the sample is monitored. As long as the substance is a solid, it has a fixed and finite heat capacity, so its temperature linearly increases at a rate governed by the rate of heat flow. Once the substance begins to melt, the heat capacity of the system goes to infinity because all absorbed heat is used to transform the solid phase into the liquid phase. The temperature of the sample cannot change during this process owing to the infinite value of the heat capacity and the fact that any heat entering the system acts only to redistribute the relative amounts of the two phases. Once the entire sample has melted, however, the heat capacity again becomes fixed and finite because the substance is now a simple liquid. Further heating results in a linear rate of temperature increase up to the next phase transition.

Differential thermal analysis (DTA) represents an improvement to the melting point determination in that the difference in temperature between the sample and a reference is monitored as a function of temperature.⁵⁰ As long as no thermal transitions take place, the temperature of the sample and the reference will be the same because the heat capacities of the two are roughly equivalent. However, differences in temperature between the sample and reference are manifested when changes occur that require a finite heat of reaction. If ΔH for the transition is positive (endothermic reaction), the temperature of

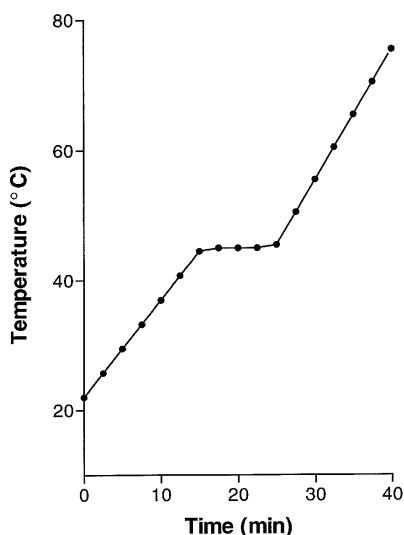

FIGURE 6 Fusion curve for the melting of a hypothetical compound.

the sample will lag behind that of the reference (because more heat will be absorbed by the sample than by the reference) and this event will be recorded in the thermogram as a negative-going peak. If the ΔH is negative (exothermic reaction), the temperature of the sample will exceed that of the reference (because the sample itself will be a source of additional heat) and the event will be recorded in the thermogram as a positive-going peak. Thus, DTA analysis is an excellent qualitative technique that is useful to deduce the temperature ranges associated with a variety of thermal events, as well as to assign the endothermic or exothermic nature of these reactions.

An astounding number of studies have been published where DTA analysis was used to characterize the properties of a wide variety of materials, so only a single example will be given here. The characteristic transition temperatures of DTA endotherms obtained for the vaporization of 2,4-difluoronitrobenzene as a function of pressure have been used to obtain the phase diagram of this substance. A family of these DTA thermograms is found in Figure 7.

Differential scanning calorimetry (DSC) represents an improvement to DTA analysis, and has become one of the most widely used methods of thermal analysis. In the DSC method, the sample and the reference are kept at the same temperature and the heat flow required to maintain the equality in temperature between the two is measured.⁵¹ This equality can be achieved by placing separate heating elements in the sample and the reference cells, where the rate of heating by these elements is controlled and measured. This method of measurement is termed power-compensation DSC, and (contrary to IUPAC guidelines) it yields positive-going peaks for endothermic transitions and negative-going peaks for exothermic transitions.

Another methodology is that of heat-flux DSC, where the sample and the reference cells are heated by the same element, and the direction and magnitude of the heat being transferred between the two is monitored. Heat-flux DSC is probably a preferable method in that it yields superior baselines relative to

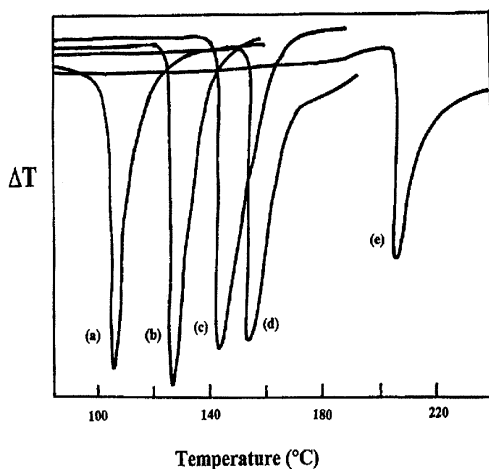

FIGURE 7 DTA endotherms obtained for vaporization of 2,4-difluoronitrobenzene as a function of pressure.

those that are obtained using power-compensation DSC. In addition, negative-going peaks are obtained for endothermic transitions and positive-going peaks are obtained for exothermic transitions (the same as for DTA analysis) that are in harmony with the IUPAC guidelines.

DSC plots are obtained as the differential rate of heating (in units of watts per second, calories per second, or Joules per second) against temperature, and thus they represent direct measures of the heat capacity of the sample. The area under a DSC peak is directly proportional to the heat absorbed or evolved by the thermal event, and integration of these peak areas yields the heat of reaction (in units of calories per second per gram or Joules per second per gram). Owing to the ability to facilitate quantitative data interpretation, the use of DSC analysis has virtually supplanted the use of DTA analysis.

When a compound is observed to melt without decomposition, DSC analysis can be used to determine the absolute purity.⁵² This method can, therefore, be used to evaluate the absolute purity of a given compound without reference to a standard, with purities being obtained in terms of mole percent. The method is limited to reasonably pure compounds that melt without decomposition, because the assumptions that justify the methodology fail when the compound purity is less than approximately 97 mol%.

One other commonly used thermoanalytical technique is that of thermogravimetry (TG), where the thermally induced weight loss of a material is measured as a function of the applied temperature.⁵³ TG analysis is restricted to studies that involve either a mass gain or loss (usually loss), and is most commonly used to study desolvation processes and compound decomposition. The major use of TG analysis is the quantitative determination of the total volatile content of a solid. When a solid can decompose by means of several discrete, sequential reactions, the magnitude of each step can be separately evaluated. TG analysis of compound decomposition also can be used to compare the stability of similar compounds. The higher the decomposition temperature of a given compound, the more negative is the ΔG value and, therefore, the greater is the stability.

An example will be cited to illustrate the synergistic relationship that exists between DSC and TG analysis. The anhydrate, dihydrate, and trihydrate phases of chemically pure magnesium stearate and magnesium palmitate were prepared and characterized as to their structural characteristics.⁵⁴ The crystal structures of the various materials were found to be very similar to each other, differing primarily in the magnitude of the long (001 face) crystal spacing. The full thermal characterization of magnesium stearate dihydrate is shown in Figure 8. The nature of the lowest temperature endothermic transition seen in the DSC thermogram is established as a dehydration transition, because a substantial weight loss is observed to take place over the same temperature interval. On the other hand, the higher temperature endothermic transition in the DSC thermogram is confirmed as a melting transition because this event takes place without any accompanying loss in mass.

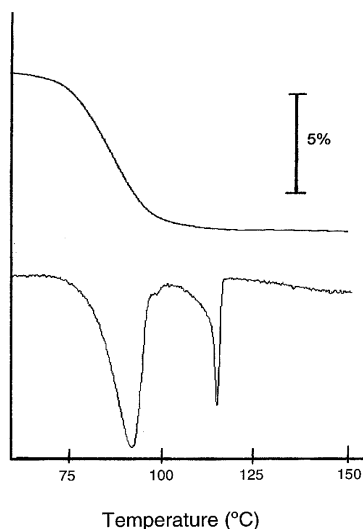

FIGURE 8 Differential scanning calorimetry (lower trace) and thermogravimetry (upper trace) thermograms obtained for the dihydrate phase of magnesium stearate. The data were adapted from reference 54.

IV. PROPERTIES ASSOCIATED WITH THE BULK LEVEL

Bulk material properties may be conveniently defined as those characteristics of a solid that can be measured only for a large ensemble of particles. Given the sheer magnitude of the materials issues involved, it is safe to state that once a solid formulation has reached the bulk manufacturing stage, the bulk physical properties are of the highest degree of importance. The ability to totally control a large-scale formulation process is governed by the degree of knowledge amassed for the system in question, and the most pertinent body of knowledge concerns the properties that directly relate to those of the bulk powders involved. It is also true that reproducibility in all aspects of lot-to-lot behavior can be significantly improved through the implementation of properly designed specifications. The testing of raw materials is particularly important at this stage, because only those species that pass appropriate challenges are used for the manufacturing process.⁵⁵

Once a given drug candidate has reached the latter stages of development, the physical characteristics associated with the other formulation ingredients assume a high level of importance. Excipients are included in formulations to execute some type of physical effect, such as enhancing powder compaction, promoting dosage form dissolution, modifying drug release rates, and improving powder flowability. It is almost self-evident that assays suitable for the evaluation of functionality properties of excipients are essential to the development of robust pharmaceutical formulations. This evaluation requires the establishment of comprehensive programs for the physical characterization of excipient materials, especially with respect to properties related to use and functionality.

It is beyond the scope of the present coverage to discuss sampling effects, but it cannot be stressed too often that the ability to obtain relevant information on the bulk properties of a material depends critically on the sampling plan used. It is fairly easy to introduce bias unintentionally during the act of taking samples, and no amount of method development and validation in subsequent steps can alleviate this problem. When milligram to gram samples are removed from a multikilogram bulk, the samples must be representative of the bulk properties or else the analytical work will be absolutely valueless.

A. Particle Size Distribution

The particle size distributions of drugs and excipients exerts profound effects on mixing phenomena and on possible segregation in mixed materials.⁵⁶ It is generally accepted that in the absence of electrostatic effects, it is easiest to produce homogeneously mixed powders if the individual components to be mixed are of equivalent particle size. The distribution of particle sizes in a powdered material can affect the bioavailability of certain active drugs, and certainly exerts a major effect on powder flowability. All pharmaceutical dosage forms must be produced in uniform units, and good content uniformity is only possible when the particle size of the active component is carefully controlled.

A variety of methods are available for determination of the particle size distribution of powdered solids.⁵⁷ The most important of these are optical microscopy (usually combined with image analysis), sieve analysis, laser light scattering of suspended particles, and electrical zone sensing.

The choice of sizing method should be made after taking into consideration the type of sample to be analyzed and the nature of information required. Whereas light scattering and electrical zone sensing are normally carried out on solids dispersed in an inert solvent medium, they are most suited for determinations of particle size distribution in suspensions. Difficulties can arise when either technique is used blindly to size dry powders, because the suspension process can grossly affect the size distributions obtained by these methods. The data will reflect what exists in the suspending medium, which may not necessarily reliably indicate what existed in the original powder sample. Microscopy and sieving are normally carried out on dry powder samples and are, therefore, more useful as indicators of the actual particle size of a powdered solid.

When proper sampling techniques are used, the most absolute method of particle size determination is that of microscopy, and this becomes most efficient when combined with some form of image analysis.⁵⁸ Calibration of observed image is easily effected through the use of stage micrometers, and once calibrated, a given set of optics will not require recalibration. In the automated methodology, microscope parameters are adjusted so as to optimize the contrast between the background and the particles to be sized. A video image of the powder is transmitted to a computer system, which then counts the number of pixels that make up a particle. The size of each pixel is easily converted to micrometers and the data are analyzed as desired by the analyst. Average particle sizes, full weight distributions, or shape information can be generated. The advantage of the optical microscope method is that it provides

direct and absolute information on the particles under characterization. Its chief disadvantage is that it can provide only data on the particles on the slide and, therefore, can be biased by the slide preparation method.

In principle, sieve analysis represents the simplest method for the determination of particle sizes, and it is certainly one of the most widely used methods.⁵⁹ The methodology for analytical sieving is currently being standardized by the United States Pharmacopoeia, but may be summarized as follows. Particles are allowed to distribute among a series of screens (typically wire mesh) and the amount of material retained on each screen is determined. The smaller particles that pass through a screen are termed the fines, whereas the larger particles that remain on the screen are the coarse particles. When multiple screens are used, the intermediate sized particles that pass through one or more screens (but that are retained on a subsequent screen) are called the medium fractions. A variety of facilitation methods can be provided during the sieving process; vibration, ultrasound, or air suspension are used to assist the passage of particles through the various screens. A proper size determination requires the use of five to six sieves, whose sizes are selected to obtain approximately equal amounts of powder on each screen and past the smallest sieve. The data are most commonly displayed as the percent of material retained on each sieve, the cumulative percent of sample retained, and the percent of sample passing each sieve. A general system for standardization of sieve data has been proposed.⁶⁰

Particle sizing also may be performed using electrical zone sensing (methodology based on the Coulter principle), in which the measurement of electrical pulses caused by the passage of particles through a sensing zone is used to deduce size information.⁶¹ One drawback to the Coulter method is that calibration using monodispersed particles of known diameter is required to assign the particle sizes of unknown species. The lowest size limits that can be measured are limited by thermal and electrical noise, and by the ability of the discrimination electronics to distinguish true signal pulses from the background.

For particles in the 1–200- μm size range, Fraunhofer diffraction can be used to obtain particle size distributions.⁶² Owing to its relative ease of operation, this technique has become enormously popular. Samples can be dispersed in the laser beam either as suspensions in an inert fluid or as dry powders aspirated directly into the analyzing beam. It is safe to state that validation of the methodology is crucial, in that it must be verified that the method of sample handling and processing does not alter the particle size distribution of the substance.

The Fraunhofer method entails an interpretation of the scattering of collimated laser light (at low angles of angles of incidence) caused by suspended particles, and particle size distributions are then deduced from the scattering intensities. It is not generally appreciated that the results generated after deconvolution of laser light scattering data are strongly dependent on a number of factors, some of which depend on the identity of the company that manufactured the measuring system. After passing through the sample, the laser light is passed through a Fourier lens to produce a diffraction pattern that is allowed to fall on a detector that consists of a sequence of concentric rings. The light

intensity that impinges on each ring is measured, yielding a pattern of radial intensity values.

To deduce a particle size distribution, the detector response must be deconvoluted by means of a simulation calculation. The scattering particles are assumed to be spherical in shape, and the data are subjected to one of three different computational methods. One system uses the *unimodal model-dependent method*, which begins with the assumption of a model (such as log normal) for the size distribution. The detector response expected for this distribution is simulated, and then the model parameters are optimized by minimizing the sum of squared deviations from the measured and the simulated detector responses. The model parameters are finally used to modify the originally chosen size distribution, and it is this modified distribution that is presented to the analyst as the final result.

A second approach uses the *unimodal model-independent method*, which begins with the assumption that the size distribution consists of a finite number of fixed size classes. The detector response expected for this distribution is simulated, and then the weight fractions in each size class are optimized through a minimization of the sum of squared deviations from the measured and simulated detector responses. The third system uses the *multimodal model-independent method*. For this, diffraction patterns for known size distributions are simulated, random noise is superimposed on the patterns, and then the expected element responses for the detector configuration are calculated. The patterns are inverted by the same minimization algorithm, and these inverted patterns are compared with known distributions to check for qualitative correctness.

Whereas virtually every light scattering system uses a different combination of model choice and deconvolution algorithm, it is highly difficult to compare the results obtained on one instrument with those obtained on a different type of system. The results obtained from a light scattering study often bear no resemblance to results obtained using either microscopy or sieving. Nevertheless, the technique can be highly useful to monitor batch-to-batch variations in size distribution, although such comparisons have value only when the particle morphology is unchanged in the various samples studied.

B. Micromeritics

When applied to powders, micromeritics is taken to include the fields that relate to the nature of the surfaces that make up the solid. Of all the properties that could be measured, the surface area, porosity, and density of a material are generally considered to be the most pharmaceutically relevant parameters.

The surface area of a solid material is important in that it provides information on the available void spaces on the surfaces of a powdered solid.⁶³ In addition, the dissolution rate of a solid is partially determined by its surface area. The most reproducible measurements of the surface area of a solid are obtained by adsorbing a monolayer of inert gas onto the solid surface at reduced temperature and subsequently desorbing this gas at room temperature. The sorption isotherms obtained in this technique are interpreted using the equations developed by Brunauer, Emmett, and Teller.⁶⁴ and, therefore,

the technique is referred to as the BET method. The surface area is obtained in units of square meters of surface per gram of material.

Any condensable, inert gas can be used for BET measurements, but the preferred gases are nitrogen and krypton. Nitrogen is used for most samples that exhibit surface areas of $2 \text{ m}^2/\text{g}$ or greater, but materials with smaller surface areas should be measured using krypton. The gas to be adsorbed (the adsorbate) is mixed with an inert, noncondensable, carrier gas (usually helium). A range of 5–30% adsorbate in carrier gas is commonly used, and the use of multiple adsorbate gas levels in a BET determination is recommended.

Relationships between the internal surface area and tablet properties have been drawn through the characterization of a variety of lactose compacts.⁶⁵ For example, a given bulk sample of anhydrous α -lactose was sieved into selected size fractions, and compacts of these fractions were prepared through compression at 37.5 mPa. Nitrogen gas adsorption was used to evaluate the surface area of the compacts and the tablet crushing strengths of each were determined. The crushing strength of the compacts was found to be directly proportional to (and almost linearly dependent on) the surface area of the compacted material. It also was found that compacts prepared from the coarser size fractions contained significantly lower surface areas than compacts prepared from the fine fractions.

Although a variety of methods are available to characterize the interstitial voids of a solid, the most useful of these is that of mercury intrusion porosimetry.⁶⁶ This method is widely used to determine the pore size distribution of porous materials and the void size of tablets and compacts. This method is based on the capillary rise phenomenon in which excess pressure is required to force a nonwetting liquid into a narrow volume.

Mercury, which has a contact angle on glass of approximately 140° , is most commonly used as the intrusion fluid. The mercury is forced into the pores of the sample using an externally applied pressure: the smallest pores require the highest pressures to effect filling. The Washburn equation, as applied to circular pore openings, is used to relate the applied pressure and the pore size opening.

Measurements of particle porosity are a valuable supplement to studies of specific surface area, and such data are particularly useful in the evaluation of materials used in direct compression processes. For example, both micromeritic properties were measured for several different types of cellulose-type excipients.⁶⁷ BET surface areas were used to evaluate all types of pore structures, whereas the method of mercury intrusion porosimetry used could not detect pores smaller than 10 nm. The data permitted a ready differentiation between the intraparticle pore structure of microcrystalline and agglomerated cellulose powders.

Another extremely important micromeritic parameter is powder density, which is defined as the ratio of mass to volume. Three types of density, which differ in their determination of volume occupied by the powder, are normally differentiated. *Bulk* density is obtained by measuring the volume of a known mass of powder sample (that has been passed through a mesh screen) into a suitable volume-measuring apparatus.⁶⁸ When a graduated cylinder is used for the measurement, the volume is determined to the nearest milliliter. The bulk

density is then obtained by dividing the mass of solid by the unsettled apparent volume. A measurement of *tapped* density is normally obtained at the same time, where the volume of the solid is measured after subjecting the system to a number of controlled shocks. The repeated mechanical stress causes the powder bed to pack into a smaller volume, so it follows that the tapped density will always be higher than the bulk density.

The *true* density of a solid is the average mass per unit volume, exclusive of all voids that are not a fundamental part of the molecular packing arrangement.⁶⁹ This density parameter is normally measured by helium pycnometry, where the volume occupied by a known mass of powder is determined by measuring the volume of gas displaced by the powder. The true density of a solid is an intrinsic property characteristic of the analyte and is determined by the composition of the unit cell.

C. Powder Characterization

Evaluation of the mechanical characteristics of powdered solids is vitally important to the processing of these materials. Information can be obtained on bulk powders prior to their processing, during the compaction process through the instrumentation of tablet presses, or on tablet compacts after they have been compressed. In the first instance, work is generally centered on determinations of the degree of flowability associated with a given powder. Data obtained during the compaction of powdered solids can be an invaluable source of information to optimize the consolidation process. Measurements conducted on consolidated materials are also used during process optimization and can be employed as part of quality control testing. It should be recognized, however, that particle–particle interactions⁷⁰ are at the center of these investigations, and all the methods are designed to deduce such information.

It is generally agreed that one of the more important parameters of interest to formulators is the flowability of powdered solids.^{71, 72} The processability of these materials is greatly affected by flowability concerns, because the materials invariably need to be moved from place to place. For example, when tablets are to be compressed at high speeds, the efficiency of the machine will be suitable only if the powder feed can be delivered at a sufficiently high rate. Whereas many pharmaceutical compounds are cohesive in nature, their flow characteristics tend to be undesirable.⁷³ One of the aims of granulation is reduce the cohesive nature of the individual components to produce a uniformly blended material whose physical properties are more suitable for processing.

Carr⁷⁴ described a system that can be extremely useful in the evaluation of the flowability of powdered solids. In his approach, Carr defined a number of parameters related to flow that are scored after their measurement according to a weighting system. Powder flowability is evaluated using the *angle of repose* (defined as the angle formed when a cone of powder is poured onto a flat surface), the *angle of spatula* (defined as the angle formed when material is raised on a flat surface out of a bulk pile), *compressibility* (obtained from measurement of the bulk and tapped material densities), and *cohesion* (relating to the attractive forces that exist on particle surfaces). The overall summation of these parameters permits deductions regarding the degree of powder flowability.

When powders flow, they do so either in a steady controlled fashion (as in the case of dry sand) or in an uncontrolled gushing manner (as in the case of damp sand, for which the entire bulk tries to move in a solid mass). This latter condition is termed *floodable* flow and is most characteristic of the flow of cohesive, sticky powders. The floodability of a powder is determined by its overall flowability (determination of which was just described), the *angle of fall* (obtained as the new repose angle when the powder cone is mechanically shocked), the *dispersibility* (ability of a given powder to become fluidized), and the *angle of difference* (obtained as the numerical difference between the angle of fall and the angle of repose). Carr⁶⁰ also detailed a procedure whereby indices are deduced for each floodability parameter and explained how the summation of these indices yields a parameter indicative of the tendency of a powder to exhibit floodable flow.

To illustrate the utility of Carr's method in the evaluation of powder flow, full characterization of 12 lots of microcrystalline cellulose was carried out.⁷⁵ Measurements of the actual mass flow rates were obtained, as well as measurements of each of the parameters specified by Carr. As evident in Figure 9, the overall flowability index proved to be a reliable predictor of the relative degree of bulk powder flow for granular material grades, but the correlation with actual flow rates did not hold for fine material grades. Detailed comparisons of the possible relationship of each parameter with the mass flow rates were conducted with the aim of determining which parameter exerted the largest influence over the mass flow rate. For the microcrystalline cellulose samples evaluated in this study, it was learned that the powder flow rates were determined largely by the sample compressibility and degrees of cohesion. Fairly well defined, but separate, inverse linear relationships were deduced between these properties and the mass flow rates. Interestingly, only a poor correlation between actual powder flow rates and the angle of repose was detected, in

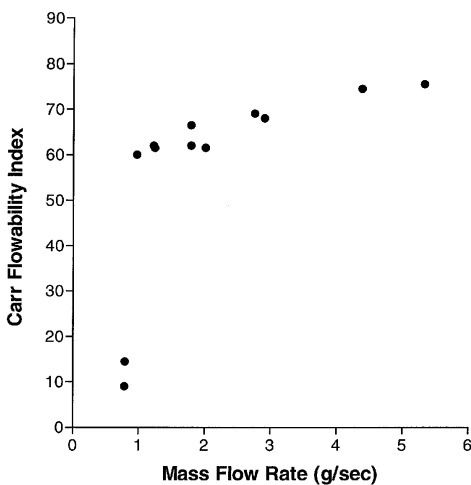

FIGURE 9 Correlation between actual mass flow rates and the Carr flowability indices of 12 samples of microcrystalline cellulose that had differing particle size distributions.

spite of the conventional wisdom that the repose angle is a reliable indicator of powder flow.⁷⁶

Studies that involve instrumented compaction equipment can be extremely useful in the development of dosage forms, especially when the amount of drug substance is limited in quantity. Marshall⁷⁷ described a program in which dynamic studies of powder compaction can be used at all stages of the development process to acquire formulation information. The initial experiments include a determination of the intrinsic compactibility of the compound. In subsequent work, simple tablets are prepared, and tested for dissolution, potency, and content uniformity. Through studies of the compaction mechanism, it is possible to deduce means to improve the formulation under study. When the work is carried out on a compaction simulator, it is possible to subject the formulation to high-speed tableting cycles so that strain forces in the compacts can be evaluated. This work can be of utmost importance, because it appears that strain rates can exert strong influences on a variety of tablet properties.⁷⁸ The information gathered in this way can be used to aid in transfer of the manufacturing process among different types of instrumentation and to aid in the technology transfer process.

In one study, the formulation efficiency of several direct compression materials was evaluated using instrumented press methodology.⁷⁹ It was found that subtle changes in the structure of the component particles could lead to observation of significantly different behaviors upon compression. The tablet hardness and compressibility of differently sourced sucrose materials, obtained at comparable compressional forces, was found to vary significantly with the source of the compound.

Most workers evaluate the quality of compacted materials through measurements of tablet hardness and friability. Hiestand and Smith⁸⁰ developed several indices of tableting performance that are indicative of the performance of materials during their compaction. The *bonding index* is an estimation of the survival of tablet strength following the decompression that takes place after the tablet is ejected from the press. The *brittle fracture index* is a measure of the brittleness of a material, and it provides a measure of the ability of a compact to relieve stress through plastic deformation. Finally, the *strain index* is an indicator of the relative strain that forms in a compact following its decompression.

Brittle fracture indices were obtained for a series of compacted direct compression excipients that had been exposed to various degrees of ambient relative humidity.⁸¹ Compacts of essentially nonhygroscopic microcrystalline cellulose exhibited essentially the same degree of brittleness regardless of exposure to relative humidity. On the other hand, compacts of more hygroscopic processed sugar materials exhibit a substantial decrease in tablet brittleness as the tablets are exposed to higher degrees of relative humidity. These phenomena were ascribed to the plasticizing effects of the adsorbed water.

V. SUMMARY

The range of solid-state analysis presented here was limited by space constraints, but interested workers should read the more detailed monograph³

that provides a more detailed overview of the systematic, materials science approach that is highly appropriate for the pharmaceutical field. Ideally, every lot of active drug, excipients, or formulated blends of these would be characterized as fully as possible at the early stages of drug development. A feedback loop would then be established after each formulation run, in which the physical characteristics of the input materials were correlated with the quality of the produced product. Out of these studies would come an understanding of the particular physical properties that are predictive of success in the production of a given formulation. As the maturity of the process increases, only these key parameters would require continued monitoring. Ultimately, the data collected on these properties would permit the generation of appropriate material specifications. If the work was performed properly, then it would be possible to specify limits for raw material properties that would ensure that the final product will always turn out satisfactorily. Such is the nature of the goal that appears to be achievable.

REFERENCES

1. Byrn, S. R., Pfeiffer, R. R., and Stowell, J. G. *Solid State Chemistry of Drugs*, 2nd ed. SSCI Inc., West Lafayette, IN, 1999.
2. Lachman, L., Lieberman, H. A., and Kanig, J. L. *The Theory and Practice of Industrial Pharmacy*, 3rd ed. Lea and Febiger, Philadelphia, 1986.
3. Brittain, H. G. *Physical Characterization of Pharmaceutical Solids*. Dekker, New York, 1994.
4. Byrn, S. R. *J. Pharm. Sci.* 65:1, 1976.
5. Monkhouse, D. C. and Van Campen, L. *Drug Dev. Ind. Pharm.* 10:1175, 1984.
6. Brittain, H. G., Bogdanowich, S. J., Bugay, D. E., DeVincentis, J., Lewen, G., and Newman, A. W. *Pharm. Res.* 8:963, 1991.
7. Wells, J. I. *Pharmaceutical Preformulation: The Physicochemical Properties of Drug Substances*. Halsted, New York, 1988.
8. Kortüm, G. *Reflectance Spectroscopy*. Springer-Verlag, New York, 1969.
9. Wendlandt, W. W. and Hecht, H. G. *Reflectance Spectroscopy*. Interscience, New York, 1966.
10. Frei, R. W. and MacNeil, J. D. *Diffuse Reflectance Spectroscopy in Environmental Problem Solving*. CRC Press, Cleveland, OH, 1973.
11. Pope, D. G. and Lach, J. L. *Pharm. Acta Helv.* 50:165, 1975.
12. Jozwiakowski, M. J. and Connors, K. A. *J. Pharm. Sci.* 77:241, 1988.
13. *Colorimetry*, 2nd ed., Publication 15.2. Central Bureau of CIE, Vienna, 1986.
14. Judd, D. B. and Wyszecki, G. *Color in Business, Science, and Industry*, 2nd ed., pp. 264–361. Wiley, New York, 1963.
15. Billmeyer, F. W., Jr. and Saltzman, M. *Principles of Color Technology*. Wiley-Interscience, New York, 1966.
16. Wirth, M. *J. Pharm. Sci.* 80:1177, 1991.
17. Krishnan, K. and Ferraro, J. R. *Fourier Transform Infrared Spectroscopy*, Vol. 4. Academic Press, New York, 1982.
18. Conley, R. T. *Infrared Spectroscopy*. Allyn and Bacon, Boston, 1966.
19. Zornoza, A., de No, C., Martin, C., Goni, M. M., Martinez-Oharriz, M. C., and Velaz, I. *Int. J. Pharm.* 186:199, 1999.
20. Colthup, N. B., Daly, L. H., and Wiberley, S. E. *Introduction to Infrared and Raman Spectroscopy*, 2nd ed. Academic Press, London, 1975.
21. Ikuta, A., Suzuki, Y., Nibu, Y., Shimada, H., and Shimada, R. *Bull. Chem. Soc. Jpn.* 72:963, 1999.
22. Ciurczak, E. W. *Appl. Spectrosc. Rev.* 23:147, 1987.
23. MacDonald, B. F. and Prebble, K. A. *J. Pharm. Biomed. Anal.* 11:1077, 1993.
24. Fyfe, C. A. *Solid State NMR for Chemists*. CFC Press, Guelph, 1983.

25. Bugay, D. E. *Pharm. Res.* 10:317, 1993.
26. Brittain, H. G., Morris, K. R., Bugay, D. E., Thakur, A. B., and Serajuddin, A. T. M. *J. Pharm. Biomed. Anal.* 11:1063, 1993.
27. Doherty, C. and York, P. *Int. J. Pharm.* 47:141, 1988.
28. Raghavan, K., Dwivedi, A., Campbell, G. C., Johnston, E., Levorse, D., McCauley, J. A., and Hussain, M. *Pharm. Res.* 10:900, 1993.
29. Ip, D. P., Brenner, G. S., Stevenson, J. M., Lindenbaum, S., Fouglaas, A. W., Klein, S. D., and McCauley, J. A. *Int. J. Pharm.* 28:183, 1989.
30. Anwar, J., Tarling, S. E., and Barnes, P. J. *Pharm. Sci.* 78:337, 1989.
31. Fletton, R. A., Harris, R. K., Kenwright, A. M., Lancaster, R. W., Packer, K. J., and Sheppard, N. *Spectrochim. Acta* 43A:1111, 1987.
32. Harris, R. K., Say, B. J., Yeung, R. R., Fletton, R. A., and Lancaster, R. W. *Spectrochim. Acta* 45A:465, 1989.
33. McCrone, W. C., McCrone, L. B., and Delly, J. G. *Polarized Light Microscopy*. Ann Arbor Science Publishers, Ann Arbor, MI, 1978.
34. Rochow, T. G. and Rochow, E. G. *An Introduction to Microscopy by Means of Light, Electrons, X-rays, or Ultrasound*. Plenum, New York, 1978.
35. Amidon, G. E. *Pharm. Forum* 18:4089, 1992.
36. McCrone, W. C. *Fusion Methods in Chemical Microscopy*. Interscience, New York, 1957.
37. Kuhnert-Brandstätter, M. *Thermomicroscopy in the Analysis of Pharmaceuticals*. Pergamon, Oxford, 1971.
38. Shangraw, R. F., Wallace, J. W., and Bowers, F. M. *Pharm. Technol.* 5:44, 1981.
39. Matthews, G. P., Lowther, N., and Shott, M. J. *Int. J. Pharm.* 50:111, 1989.
40. Boles, M. O., Girven, R. J., and Gane, P. A. C. *Acta Crystallogr., Sect. B* 34:461, 1978.
41. Bragg, W. H. and Bragg, W. L. *X-Rays and Crystal Structure*. G. Bell & Sons, London, 1918.
42. Woolfson, M. M. *X-Ray Crystallography*. Cambridge Univ. Press, Cambridge, UK, 1970.
43. Stout, G. H. and Jensen, L. H. *X-Ray Structure Determination: A Practical Guide*. Macmillan, New York, 1968.
44. Bernstein, J. Conformational polymorphism. In *Organic Solid State Chemistry* (G. R. Desiraju, Ed.), Chap. 13, pp. 471–518. Elsevier, Amsterdam, 1987.
45. Klug, H. P. and Alexander, L. E. *X-Ray Diffraction Procedures for Polycrystalline and Amorphous Materials*, 2nd ed. Wiley-Interscience, New York, 1974.
46. Catlow, R. A., Thomas, J. M., Freeman, C. M., Wright, P. A., and Bell, R. G. *Proc. R. Soc. London, Ser. A* 442:85, 1993.
47. Brittain, H. G. *J. Pharm. Biomed. Anal.* 15:1143, 1997.
48. Wendlandt, W. W. *Thermal Analysis*, 3rd ed. Wiley, New York, 1986.
49. Giron, D. *J. Pharm. Biomed. Anal.* 4:755, 1986.
50. Pope, M. I. and Judd, M. D. *Introduction to Differential Thermal Analysis*. Heyden, London, 1977.
51. Dollimore, D. Thermoanalytical instrumentation. In *Analytical Instrumentation Handbook* (G. W. Ewing, Ed.), pp. 905–960. Dekker, New York, 1990.
52. Blaine, R. L. and Schoff, C. K. *Purity Determinations by Thermal Methods*. ASTM Press, Philadelphia, 1984.
53. Keattch, C. J. and Dollimore, D. *Introduction to Thermogravimetry*, 2nd ed. Heyden, London, 1975.
54. Sharpe, S. A., Celik, M., Newman, A. W., and Brittain, H. G. *Struct. Chem.* 8:73, 1997.
55. Brittain, H. G. *Pharm. Technol.* 17(7):66, 1993.
56. Carson, J. W. *Drug Dev. Ind. Pharm.* 14:2749, 1988.
57. Barth, H. G. *Modern Methods of Particle Size Analysis*. Wiley, New York, 1984.
58. Kaye, B. H. *Direct Characterization of Fine Particles*. Wiley, New York, 1981.
59. Fayad, M. E. and Otten, L. *Handbook of Powder Science and Technology*. Van Nostrand Reinhold, New York, 1984.
60. Brittain, H. G. *Pharm. Forum* 19:4640, 1993.
61. Allen, T. *Particle Size Measurement*, 3rd ed. Chapman and Hall, London, 1981.
62. Chu, B. *Laser Light Scattering*. Academic Press, New York, 1974.
63. Lowell, S. and Shields, J. E. *Powder Surface Area and Porosity*, 2nd ed. Chapman and Hall, London, 1984.

64. Brunauer, S., Emmett, P. H., and Teller, E. *J. Am. Chem. Soc.* 60:309, 1938.
65. Leuenberger, H., Bonney, J. D., Lerk, C. F., and Vromans, H. *Int. J. Pharm.* 52:91, 1989.
66. Hayes, J. M. and Rossi-Doria, P. *Principles and Applications of Pore Structural Characterization*. Arrowsmith, Bristol, 1985.
67. Pesonen, T. and Paronen, P. *Drug Dev. Indust. Pharm.* 16:31, 1990.
68. Augsburg, L. and Amidon, G. E. *Pharm. Forum* 20:6931, 1994.
69. Bergren, M. S. *Pharm. Forum* 20:2334, 1994.
70. Hiestand, E. N. *J. Pharm. Sci.* 55:1325, 1966.
71. Neumann, B. S. *Adv. Pharm. Sci.* 2:181, 1967.
72. Deleuil, M. *STP Pharma* 3:668, 1987; D. Duchene, *STP Pharma* 3:794, 1987.
73. Pilpel, N. *Adv. Pharm. Sci.* 3:173, 1971.
74. Carr, R. L. *Chem. Eng.* January:163, 1965; February:69, 1965.
75. Brittain, H. G. Unpublished results.
76. Carstensen, J. T. *Pharmaceutical Principles of Solid Dosage Forms*, p. 209. Technomic, Lancaster, PA, 1993.
77. Marshall, K. *Drug Dev. Ind. Pharm.* 15:2153, 1989.
78. Celik, M. and Travers, D. N. *Drug Dev. Ind. Pharm.* 11:299, 1985.
79. Ondari, C. O., Kean, C. E., and Rhodes, C. T. *Drug Dev. Ind. Pharm.* 15:1517, 1988.
80. Hiestand, E. N. and Smith, D. P. *Powder Technol.* 38:145, 1984; *Int. J. Pharm.* 67:217, 231, 1991.
81. Malamataris, S., Goidas, P., and Dimitriou, A. *Int. J. Pharm.* 68:51, 1991.

4

DEGRADATION AND IMPURITY ANALYSIS FOR PHARMACEUTICAL DRUG CANDIDATES

**KAREN M. ALSANTE, ROBERT C. FRIEDMANN, TODD D. HATAJIK,
LINDA L. LOHR, THOMAS R. SHARP,
KIMBERLY D. SNYDER, AND EDWARD J. SZCZESNY**

*Pfizer Global Research & Development Division, Analytical Research and Development
Department, Groton, Connecticut 06340*

- I. RESIDUAL SOLVENTS AND WATER
 - A. Residual Solvents
 - B. Water
- II. PURPOSEFUL DEGRADATION STUDIES
 - A. Introduction
 - B. Drug Substance Degradation Studies
 - C. Drug Product Degradation Studies
 - D. Degradation Prediction
 - E. Key Degradation Samples for Method Development
 - F. Global Perspective of Degradation and Impurity Process
- III. ISOLATION AND IDENTIFICATION OF IMPURITIES/DEGRADANTS
 - A. Introduction
 - B. The Process
 - C. Isolation Techniques
- IV. MASS SPECTROMETRY IN IDENTIFICATION OF IMPURITIES
 - A. Introduction
 - B. The Process
 - C. The Tools
 - D. How to Use the Tools
- V. ROLE OF NMR
 - A. Introduction
 - B. Information Gathering
 - C. NMR Instrumentation
 - D. Sample Preparation
 - E. NMR Experiments
 - F. Data Interpretation
- VI. REFERENCE STANDARDS
 - A. The Process
 - B. Amount of Reference Standard
 - C. Isolation Approach Involving Reaction Enrichment
- VII. SUMMARY
- REFERENCES

Impurity and degradant structure elucidation is a collaborative effort involving the analytical chemist, process chemist, and/or formulator as well as experts in degradation, mass spectrometry, and nuclear magnetic resonance (NMR). The process described in this chapter uses a designed approach for the impurity and/or degradant identification, which focuses on efficiency, so that the success of data collection is maximized. A number of activities other than collecting experimental data are included, even though the experiments are central to the process. The process used for determination of residual solvents, purposeful degradation studies, and isolation/identification of impurities and degradants, as well as insights into the effectiveness and efficiency of our team approach, is described in this chapter.

I. RESIDUAL SOLVENTS AND WATER

A. Residual Solvents

Most process steps involved in the manufacture of drug substances, intermediates, and regulatory starting materials occur in the presence of a solvent or combination of solvents. Depending on the manufacturing process and regulatory requirements, these materials may be tested for the amount of solvent(s) present in the sample by the compendial methods.

Residual solvent testing is important in the pharmaceutical industry for several reasons. For a drug substance, solvent content will affect its potency. From a safety perspective, depending on the dosage strength of the drug substance and the duration of the treatment, the amount of solvent or solvents entering a patient must be safe toxicologically. For example, daily exposure to toluene permitted according to the International Conference on Harmonisation (ICH) is 8.9 mg/day.¹ In addition to health concerns, the total amount of solvents in a drug substance could adversely affect how the material behaves during formulation.

Testing for solvent content in intermediates may need to be performed if a critical amount of residual solvent(s) remaining in the intermediate can alter the next step of the process. Knowledge of the solvent content in regulatory starting materials may help the development chemist to understand the synthetic route and predict potential process-related impurities. Knowing the solvents used in a process allows the development chemist to look for possible compound–solvent interactions which can lead to the formation of impurities.

There are several nonspecific methods available that can determine the total amount of solvent(s) in a sample. Loss on drying (LOD) determines the amount of volatile components that are released from a sample under specific temperature and/or vacuum conditions. Thermal gravimetric analysis (TGA) measures the loss of volatile components from a sample over a temperature gradient. The advantage of these methods is that they give an estimate of the volatile component content of a sample relatively quickly. The disadvantages of these methods are that they do not speciate and cannot account for volatile components that are trapped in the lattice structure of the compound. By accepting the limitations of these methods, a total solvent amount can be

calculated if a value for water content in the sample is known, and the water value is subtracted from the value obtained from either the LOD or TGA.

To determine the identity and quantity of residual solvents in a sample, a separation of the residual solvents from the matrix and from each other must occur. Gas chromatography (GC) is well suited for this type of separation since GC relies on sample volatilization for its separation mechanism. Most solvents used in manufacturing processes have low boiling points (<200 °C), so they are easily volatilized and can be separated using the proper chromatographic and instrument conditions.

Methods can be developed to be very specific (one solvent in a very short period of time) or general (able to separate and quantitate numerous residual solvents). This section will focus on the general methods that can separate numerous residual solvents.

The advantage of a general method is that one method can analyze residual solvents in the vast majority of different samples that are submitted to a pharmaceutical laboratory. This reduces the downtime for a gas chromatograph while columns are changed. Another advantage of a general method is the analyst's familiarity with the method. For example, the sample and standard preparations are consistent for the most part and the instrument could be dedicated to the method. Experience with a method can help an analyst quickly determine the possible identity of an unknown solvent present in a sample based in its retention time. It is also easier to troubleshoot one familiar method than several methods that are occasionally used. Because the goal of a general method is to quantitate all the residual solvents in a sample (potentially numerous), it is critical that the right chromatographic system (injection scheme, instrument conditions, stationary phase, and detector) is chosen.

GC offers a chemist a number of different options to separate and quantitate residual solvents present in a sample. Numerous sample injection schemes, inlets, stationary phases, and detectors are available. Any combination can be used to develop adequate residual solvent methods. One key factor to consider is that the method of introduction must reproducibly introduce samples and standards to the gas chromatographic system; otherwise, the system and the method would not be considered to be rugged. The method of introduction and the inlet type should be compatible. For example, using a static headspace sampler and a cool on-column inlet does not offer any advantages for residual solvent analyses. The combination of a stationary phase and a temperature program (if a temperature program is chosen) should resolve all components of interest. Care should be taken to work within normal column velocities and the temperature ramping capabilities of the gas chromatograph. Methods in which compounds of interest elute at the start or the end of a temperature ramp should be avoided. Finally, the detector must be capable of detecting the compounds of interest at the appropriate levels and have an adequate operating range. For example, a flame ionization detector meets these criteria for most organic solvents.

Once the gas chromatography conditions are chosen, the next step is to decide how the samples and standards are going to be introduced to the gas chromatograph. Several techniques can be chosen with some being more prac-

tical than others. These techniques include injection of a liquid sample with a syringe, pyrolysis, thermal desorption, purge and trap, and static headspace.

Using a syringe to inject a liquid sample either manually or with an autosampler is a simple method of introduction to a gas chromatograph. Basically, a sample is dissolved or diluted in a volatile solvent and a known volume is injected into the inlet. Considerations when using this technique include ensuring that the sample is fully dissolved and that the components of the sample will be volatilized when introduced to the inlet. The inlet may be able to trap undissolved components and nonvolatile components, but it is best to avoid introducing nonvolatile components into the system. Nonvolatile components in the inlet could eventually migrate to the column and adversely affect the stationary phase. Also, nonvolatile components in the inlet could act as a trap for the volatile components of interest. The solvent chosen for the diluent must be volatile and not elute in a region of the chromatogram where components of interest are expected to elute. However, if the matrix is soluble and volatile, direct injection of a liquid sample is an acceptable method of testing for residual solvents.

Pyrolysis is a technique for nonvolatile samples that uses an analytical pyrolyzer. In a pyrolyzer, a sample is thermally fragmented into smaller volatile components. These fragments are introduced to the gas chromatograph, and the resulting chromatogram is a fingerprint of the sample. This is not a technique suitable for general residual solvent analysis. Even though a pyrolyzer will introduce residual solvents to a gas chromatograph, some of the thermal fragments from the drug substance may appear as residual solvents, thus giving an inaccurate result. The analyst will also have to determine which peaks in a chromatogram are residual solvents and which are fragmented pieces of the drug substance.

Purge and trap, or dynamic headspray is a technique in which a sample is placed in a tube with water and then sealed onto the instrument. Helium is introduced to the tube and sparges through the sample and water. The volatile components are collected onto an adsorbent trap. After a set period of time, the sparging stops and helium flow is directly routed to the adsorbent trap, which is then rapidly heated to release the volatile components. They are then transferred to the gas chromatograph. Purge and trap is a very sensitive technique that allows only volatile components to enter a gas chromatograph. The drawback of using purge and trap for routine residual solvent assay in pharmaceuticals is that only water can be used in the system. If a drug substance is not water soluble, then only residual solvents on the surface of the drug substance will be introduced to the gas chromatograph. Purge and trap can also be run on dry samples without water in the tube.

Static headspace sampling (or just headspace) is similar to purge and trap in that only volatile components are transferred to a gas chromatograph. With headspace, a sample can be run dry or it can be run in a dissolving solvent. Liquid samples can be analyzed as long as the sample amount combined with the temperature does not overpressurize the sample vial. The dissolving solvent is typically water (when a flame ionization detector is used) or a high boiling point organic solvent, e.g., dimethyl acetamide. The option of using an organic solvent or a combination of solvents allows a better chance of dissolv-

ing the sample in the headspace vial. This enables solvents that may be trapped in the drug substance lattice to be released and detected. The one drawback with headspace is that the sample is heated. In some cases, the combination of a dissolving solvent and heat could cause a chemical reaction to occur in the headspace vial that may misrepresent the presence or quantity of residual solvents in that sample.

It was mentioned previously that a flame ionization detector is a good choice for a general residual solvent analysis. Flame ionization detectors are rugged, low in cost, and easy to use. Stationary phases that may exploit some solute-stationary phase interactions would be recommended to separate a potentially wide range of residual solvents. These phases may offer more selectivity over typical "boiling point" columns (e.g., dimethylpolysiloxane stationary phases). A split/splitless injection inlet is a commonly used and rugged inlet. The three best general methods to introduce residual solvents to a gas chromatograph are use of either a liquid autosampler, a purge and trap unit, or a headspace autosampler. The addition of temperature programming and a variety of column dimensions give an analyst numerous combinations to develop a general method for determining residual solvents in drug substances. An example of one possible combination is shown in Figure 1 where a headspace autosampler, a split/splitless injector operating in the split mode, a cyanopropyl stationary phase, a temperature program, and a flame ionization detector are used to separate a variety of residual solvents.

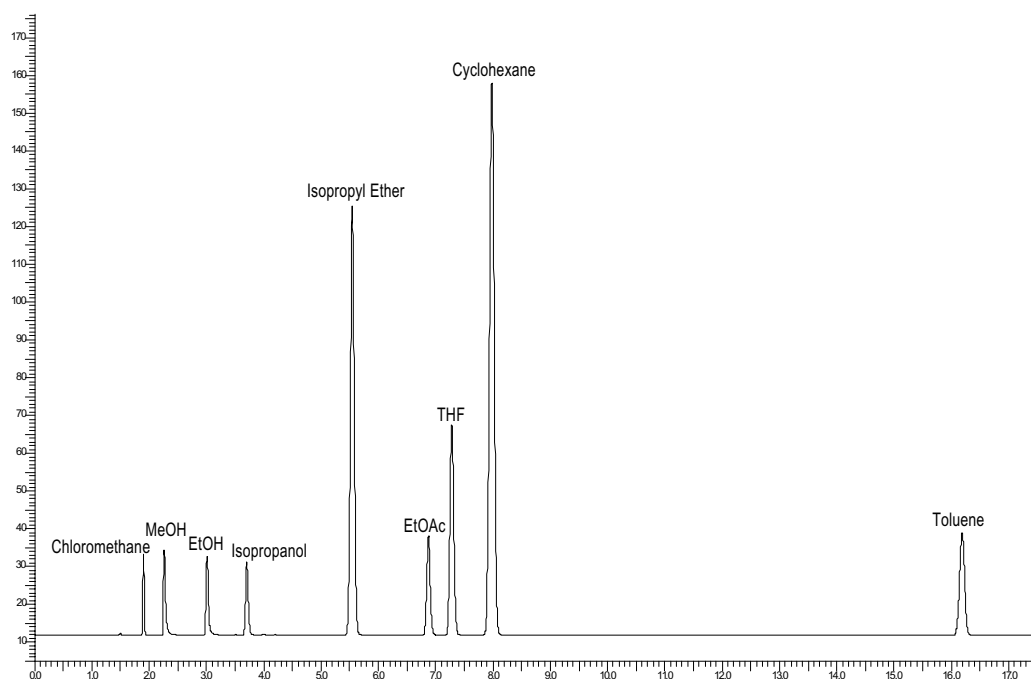

FIGURE I Example of a residual solvent analysis of a standard containing nine solvents at approximately 0.05 mg/mL.

An analyst needs to know what solvents are typically used to produce drug substances within his or her customer base and the frequency of requests for residual solvent determinations. This will help in deciding what detector and stationary phase to use. Knowing the chemical and physical attributes of the drug substances and the processes used to synthesize them will determine how samples should be prepared and what sample introduction technique makes sense.

The advantage of a general residual solvent method is that with time a knowledge base is established with the method. This allows for the setup of meaningful system suitability criteria. Another advantage of a general method is that different drug substances with various residual solvent specifications could be assayed on the same run sequence. In this case, the standards cover all of the residual solvents of interest for each of the samples. System suitability is run once to cover the many different samples, which saves instrument time.

Retention times of residual solvent standards are known when one has gained experience with a method. This knowledge can help to identify unknown compounds in a sample. Another helpful tool for identifying unknowns in a residual solvent run is the use of some form of retention index. Retention indices can be established by using a set of standards, e.g., normal hydrocarbons as in the Kovats index,² to give a value to each compound in a chromatogram. Matching values in a sample based on calculated retention indices will aid in identifying the compound.

In some cases, additional work may be required to identify unknown compounds. One of the best ways is to use a gas chromatograph coupled to a mass spectrometer. When gas chromatography–mass spectrometry (GC–MS) is performed to identify unknown compounds, it is easiest to choose the same stationary phase used in the original run. Capabilities of GC–MS may not allow for the same column dimensions to be utilized, but temperature programming can be altered to mimic the retention times on the non-GC–MS run.

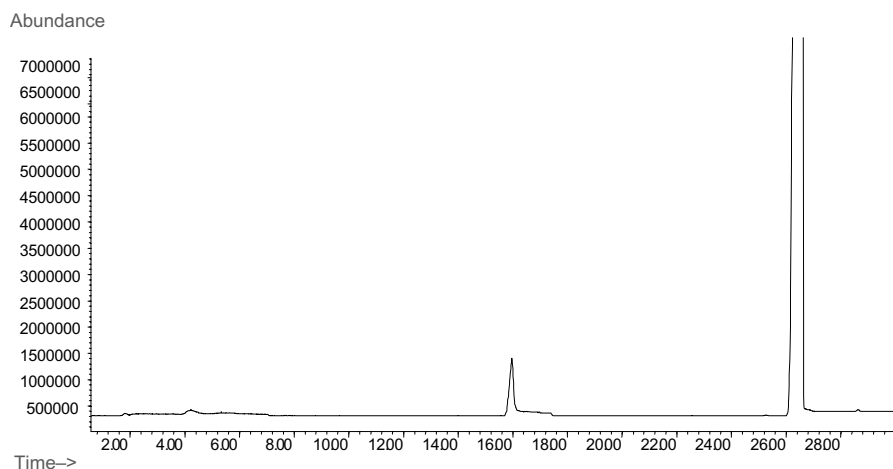

FIGURE 2 Total ion current chromatogram of a solvent run.

An example of a GC–MS run is shown in Figure 2. Toluene is known and elutes at approximately 16.8 min. An unknown compound elutes at 26.3 min. The positive electron impact spectrum for the unknown and the top library search spectrum are shown in Figure 3. A library search identified the unknown component as 1,2-dimethylbenzene. This was confirmed by spiking studies on the sample with a standard of 1,2-dimethylbenzene.

In some instances it may be necessary to track amounts of unknown residual solvents in samples if the identity has not yet been established and the unknown compounds have signal-to-noise ratios near the limit of quantitation. One option is to quantitate the unknown compounds consistently versus another compound. When a flame ionization detector is used, methanol is a good choice. Methanol gives a low response in a flame ionization detector relative to other solvents. The goal is to err on the high side when quantifying unknown compounds. The other benefit of using methanol is that it elutes early in most chromatographic systems, so run times do not need to be extended when methanol is a component of the standard.

Once chromatographic conditions have been established, the only changes to the method that may need to be made are in the sample and standard preparations. This will depend on the specifications for residual solvents in each drug substance. One way to maintain consistent conditions for most samples is to use one constant concentration for the sample preparation and to have a wide working range established by external standards (e.g., 0.01–1.0%). With a wide standard range, numerous compounds can be analyzed in the same chromatographic sequence. The other benefit of using a wide standard range is that the chances of quantitating a residual solvent when it is not close to either the specification or the expected result are increased. If one has a sample for which the normal sample preparation is outside of the range of the standards, the easiest remedy is to adjust the sample preparation to get the residual solvent in

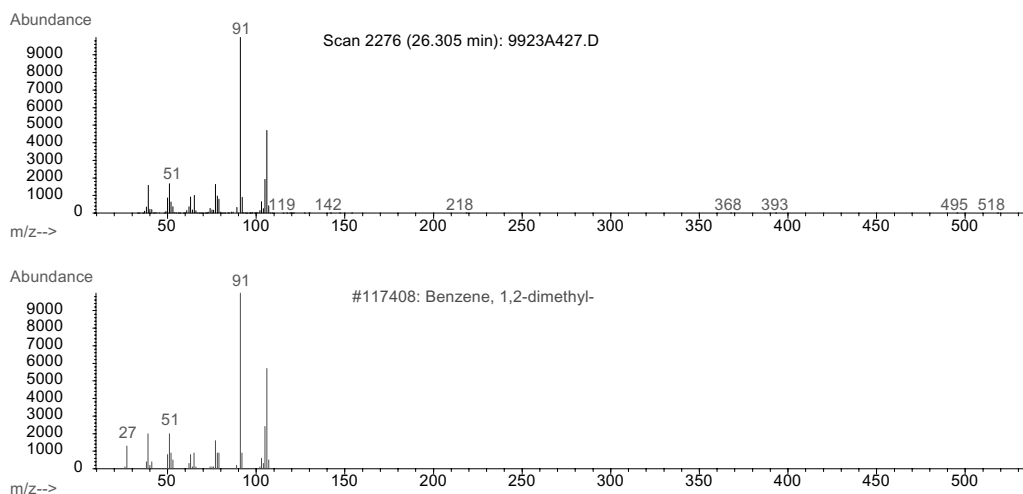

FIGURE 3 Electron impact spectrum of the unknown compound (top) and the library spectrum of 1,2-dimethylbenzene (bottom).

the sample within the range of the standards. Another option is to prepare a new set of standards to get the sample within the standard curve.

There are usually no problems when the sample concentration is decreased to get a large residual solvent peak within the standard range. If the sample concentration is increased, then one needs to make sure there are no issues with solubility. When adjusting the standard range, one needs to confirm that the new standard levels are within the linear range of the method.

B. Water

Water is an interesting compound when it comes to drug substances. In some cases, a specific amount of water is desirable, i.e., hydrates. In other cases, it is advantageous to keep water levels to a minimum because water itself can accelerate the degradation of a drug substance. Some drug substances are hydrophilic, so knowing how the compound picks up water during stability studies is important. As with residual solvents, water levels that are not within specifications for a drug substance can lead to manufacturing difficulties in formulating drug product.

There are several techniques that can be used to determine water content in samples. These techniques include TGA, loss on drying, gas chromatography, dimethoxypropane titration, near-infrared (NIR), NMR, and Karl Fischer titration.

As mentioned in Section I.A, TGA and loss on drying are two nonspecific methods for the determination of volatile components in a sample. With some drug substances, water amounts can be determined from TGA or loss on drying, but the assumptions are that only water is being released from the sample and that all of the water is being released over a short time period. From the TGA profile shown in Figure 4, the loss of weight due to water loss is approximately 11.3%. Again, the assumptions are that weight loss is due only to water

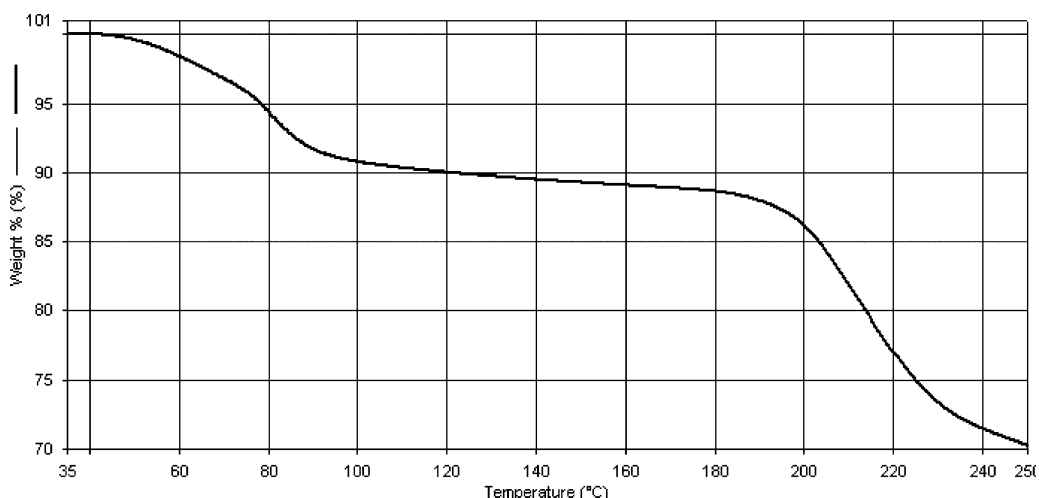

FIGURE 4 TGA of a sample exhibiting approximately 11% loss of weight.

and the sample does not tightly hold on to water. In this sample, volumetric Karl Fischer titration confirmed the TGA result, and a GC residual solvent run showed no significant levels of nonwater solvent in the sample.

Gas chromatography has been used to determine water levels in samples.^{3,4} However as a routine method of analysis for various drug substances, gas chromatography is not very practical. Many drug substances are not volatile and therefore pose sample handling issues.

Dimethoxypropane titration is a technique that utilizes a thermometric end point.⁵ The principle of this technique is that a reaction between dimethoxypropane and water is very fast and instantaneous. This technique may be difficult to work with for some drug substance matrixes but can offer an alternative option in other cases.

NMR spectroscopy has also been used to examine water amounts in drug substances.⁶ Because of the cost of instrumentation and the precautions needed to minimize external sources of water from the sample, NMR may not be practical as a routine method of water analysis. However, NMR can be used in cross-validation studies to support the primary method.

NIR spectroscopy has become a popular choice for water determination.⁷ Water absorption bands exist in the NIR region, which provide good selectivity and sensitivity. NIR is a quick and nondestructive technique. However, it is a secondary method of analysis for water. This means that a drug substance reference material of known water content must be used to validate an NIR method for that particular drug substance.

Karl Fischer titrations were first introduced in 1935⁸ and are widely used to determine water content in drug substances. The reaction is broken down into two parts and is shown in Eqs. (1) and (2).

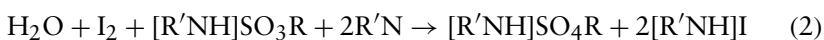

In the first part of a Karl Fischer reaction, sulfur dioxide and alcohol react to form an ester that is neutralized by an organic base. In the second step of the reaction, the alkylsulfite anion is oxidized by iodine. This second step consumes the water in the sample. The end point is determined using an electrode that provides a small potential across two platinum tips. When all of the water is consumed in the titration cell, the slight excess of titrant introduced into the cell causes an increase in the current. This increase is the indication for the end point.

In the original titration proposed by Fischer, the base chosen was pyridine. Pyridine has been replaced in most Karl Fischer titrations by another organic base (i.e., imidazole) for two main reasons. The first reason is that the pH of the system will affect the speed and the precision of the analysis. The optimum pH range for a Karl Fischer titration is between 5 and 7. If the base used in the titration is too strong, raising the pH above 7, then there is a possibility of not determining an end point. If the base is too weak and does not raise the pH to 5, then the titration occurs slowly and sometimes makes an end point difficult to determine. This can be the case when pyridine is used as the base. Imidazole is an organic base that neutralizes the acids produced in the reaction

and buffers the system within the 5–7 pH range. The second reason pyridine is not as widely used has to do with the safety of its handling.

There are several considerations when a Karl Fischer method is developed for a drug substance. The first concern focuses on the possibility of side reactions. Side reactions can effect either iodine or water. Iodide may be oxidized to iodine by reducible species. These reactions would underestimate the actual water concentration, because any additional iodine reacts with water. Conversely, iodine may be reduced to iodide by oxidizable species. These reactions overestimate the actual water content because iodine is consumed before it reacts with water.

There are also side reactions that can either produce or consume water. Water can be produced by a reaction between the sample and Karl Fischer reagents. Examples of species that can produce water include esterifiable carboxylic acids, aldehydes, ketones, and silanols. Aldehydes and ketones can also form reversible bisulfite complexes with water and sulfur dioxide. These reactions would consume water, resulting in an underestimate of the amount of water in a sample.

When one performs a volumetric Karl Fischer titration, there are two basic classes of reagents: one-component reagents and two-component reagents. The one-component reagents contain all of the reactants (iodine, sulfur dioxide, and base) in an alcohol solvent. These reagents have a large water capacity, and they are economical and easy to use. The sample is dissolved in an alcohol, but co-solvents can be used to improve sample solubility.

Two-component volumetric reagents require two separate solutions. The solvent contains sulfur dioxide and base in an alcohol. The reagent is a solution of iodine in methanol with a known titer. Advantages of two-component systems include faster titrations and greater accuracy for small amounts of water. There are, however, more possibilities for side reactions within a two-component system.

With coulometric Karl Fischer titrations, the iodine is generated electrochemically at the anode. This is a much more accurate technique for measuring water content in a sample. Sample sizes are much smaller compared with those for volumetric Karl Fischer titrations.

Depending on the instrument and the reagents, volumetric Karl Fischer titrations require samples that contain at least 1 mg of water and more typically 5–10 mg. Coulometric titrators require samples with at least 30–50 μg of water. Considerations of sample availability, solubility, and water amounts will dictate which technique is best for a particular drug substance. A chart to help one decide where to start is shown in Figure 5.

As shown in the chart, one option for handling samples whose matrix interferes with the titration is to use a vaporizer oven. These units can be used with either coulometric or volumetric units. The sample is placed in a tube oven, and the oven is heated to a set temperature. A stream of dry nitrogen, dry air, or dry argon carries the moisture released from the sample to the titration vessel. This approach can also be used with samples that undergo interfering side reactions. When ovens are used, it is important to check recoveries and to ensure that the sample does not undergo any thermal degradation that could either produce water or contaminate the system.

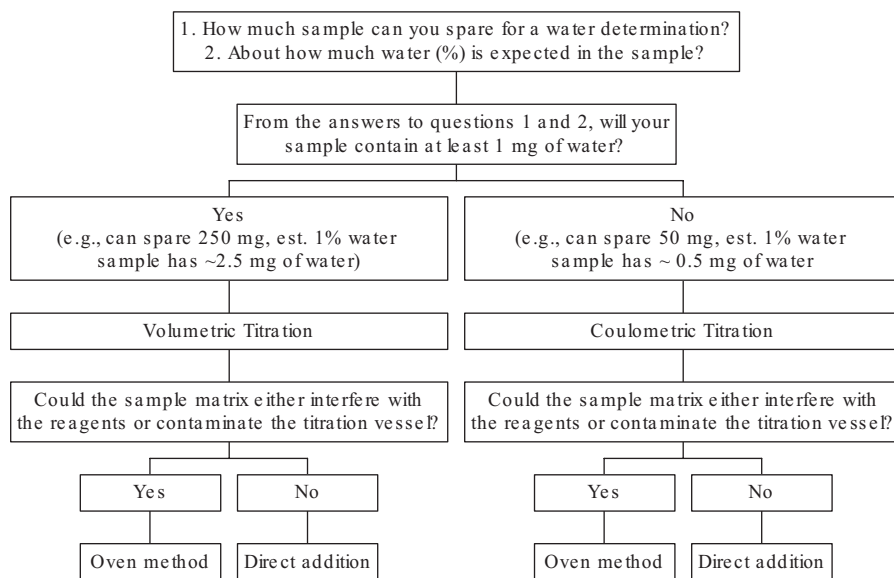

FIGURE 5 Chart for selection of Karl Fischer technique.

Co-solvents have already been mentioned briefly. These solvents can be combined with the alcohol in a titration cell to increase solubility of a sample or prevent side reactions that may affect determination of the amount of water. Examples of co-solvents are formamide for polar substances and chloroform for aldehydes and ketones. If a co-solvent is used, one must ensure that the percentage of the co-solvent is not too high. Because the Karl Fischer reaction requires alcohol, a rule of thumb should be that the co-solvent not exceed 50% of the total volume.

Once a method has been developed, proper system suitability and standard checks should be incorporated into the method. This includes procedures for finding the titer strength for volumetric systems. A decision needs to be made on how frequently this should be done, how it is accomplished, and what the acceptance criteria will be. Also, depending on the drug substance, a decision needs to be made on how often to run standard checks. Standard checks ensure that the system is not being contaminated by sample.

II. PURPOSEFUL DEGRADATION STUDIES

A. Introduction

The objective of this section is to provide guidance for developing and executing purposeful degradation experiments for pharmaceutical drug candidates. According to ICH Guidelines on Impurities in New Drug Products, a degradation product is defined as a chemical change in the drug molecule brought about over time and/or by action of, e.g., light, temperature, pH, or water, or by reaction with an excipient and/or the immediate container/closure system

(also called decomposition product).⁹ Our goals for this section are to set forth guidelines for these purposeful degradation studies and to describe the current procedures for conducting a purposeful degradation study. The critical nature of these studies is also emphasized in the ICH Guidelines⁹: “results from these studies will form an integral part of the information provided to regulatory authorities.”

The ICH Guideline on Stability Testing of New Drug Substances and Products provides some guidance on stress testing or purposeful degradation⁹:

Stress testing helps determine the intrinsic stability of the molecule by establishing degradation pathways in order to identify the likely degradation products and to validate the stability indicating power of the analytical procedures used. Stress testing is conducted to provide data on forced decomposition products and decomposition mechanisms. The severe conditions that may be encountered during distribution can be covered by stress testing. These studies should establish the inherent stability characteristics of the molecule, such as the degradation pathways, and lead to identification of the degradation products and hence support the suitability of the proposed analytical procedures. The detailed nature of the studies will depend on the individual drug substance and type of drug product.

The traditional system for developing analytical methods for active pharmaceutical ingredients as well as formulations involves performing purposeful degradation experiments in the method validation phase to challenge the specificity of the methodology.¹⁰ Using this conventional validation protocol, it is difficult to develop a stability-indicating analytical method before having “key stability-indicating” samples generated from purposeful degradation studies to challenge the methodology. The 1987 Food and Drug Administration (FDA) Stability Guideline defines stability-indicating methodology as¹¹:

Quantitative analytical methods that are based on the characteristic structural, chemical or biological properties of each active ingredient of a drug product and that will distinguish each active ingredient from its degradation products so that the active ingredient content can be accurately measured.

This approach can lead to significant method rework if the degradation sample set was developed and analyzed at the validation stage and then proves the method to be nonstability indicating. One problem with this approach is that if any of the degradation products are unknown or unanticipated, method development has to be reinitiated very late in the process. In situations such as this, further method development is required after significant validation work has already been performed.

Unlike the traditional system of validation phase testing, our approach to degradation studies starts early in the pharmaceutical drug development process. This method allows generation of samples that predict stability according to ICH guidelines and results in less rework of ICH stability programs. Thus, the analyst can challenge analytical methodology with degradation samples generated in the initial phases of method development. We are better able to assess the validity of existing analytical methodology with respect to specificity so the primary advantage to this approach is faster and more efficient method development. As stated, if delayed until the validation stage, completion of the degradation studies can be rate limiting and consequently lead to signifi-

cant delays in project timelines. This strategy provides a rational basis for the development of analytical methods, formulations, and packaging plans.

Purposeful degradation studies are not a one-time event. They are initiated in the introductory phase of the development process and continue over the lifetime of a candidate. Purposeful degradation studies include appropriate solid and solution state challenges to mimic potential future storage conditions including acid/base hydrolysis, thermal/humidity, oxidation, and light exposure in accordance with ICH guidelines. For drug product studies, placebo and drug substance are run as control samples for each condition (see Section II.C for more details).

In the following sections, a more detailed guideline will be presented on how to perform purposeful degradation experiments. Under this approach, the design of the purposeful degradation protocol is based on the drug substance and drug product chemistry. The analytical methodology is challenged with samples degraded using “reasonable conditions.” The definition of reasonable conditions is 10–20% degradation of the pharmaceutical active ingredient. Kinetic points are obtained for each condition along the degradation pathway to gain a better understanding of mechanism. Using this approach, the analyst focuses on the key primary degradation products and generates degradation samples more predictive of ICH stability. Without kinetic points, it is difficult to determine the primary degradation products and degradation mechanisms can be obscured. It is possible that in the following reaction sequence (Scheme 1), the primary decomposition product (Compound B) is not stable at elevated temperature stress and further converts to Compound C. However, under ICH stability studies, Compound B may have a significant lifetime. In this example, it is critical to capture Compound B in purposeful degradation testing. To accurately identify the key degradants that predict ICH stability, kinetic points must be taken along the reaction pathway (see Section II.D for more details).

The ICH Guideline on Stability Testing of New Drug Substances and Products states the following for stress testing or purposeful degradation⁹:

It is recognized that some degradation pathways can be complex and that under forcing conditions decomposition products may be observed which are unlikely to be formed under accelerated or long term testing. This information may be useful in developing and validating suitable analytical methods, but it may not always be necessary to examine specifically for all degradation products, if it has been demonstrated that in practice these are not formed.

If in later-stage studies significant ICH stability data are available, emphasis can be placed on the degradants observed with ICH stability conditions.

Degradation samples are analyzed at the initial phases of high-performance liquid chromatography (HPLC) method development using



SCHEME I Reaction sequence.

purity (for area percent values of degradants) and potency methods (to obtain assay values for the amount of active ingredient remaining against reference standards). By performing these analyses, the analyst is able to obtain mass balance data and a better understanding of the level of degradation occurring (see Section II.D for more details). For all conditions, samples should be examined for any changes in physical properties (appearance, clarity, and color). If polymorphism is of concern, degradation samples can be analyzed for polymorphic conversion.^{12, 13} For color measurements, a useful degradation instrument is a colorimeter. Unlike the human eye that cannot quantify color accurately, a colorimeter expresses colors numerically according to international standards. *LAB* color space is presently one of the most popular and uniform color spaces. *L*, *A*, and *B* refer to the three axes of the system: a lightness axis (*L*) and two axes representing both hue and chroma, red-green (*A*) and blue-yellow (*B*).¹⁴

B. Drug Substance Degradation Studies

Purposeful degradation studies of the drug substance include appropriate solution and solid-state stress conditions (e.g., acid/base hydrolysis, heat, humidity, oxidation, and light exposure, in accordance with ICH guidelines). Guidelines from the United States Pharmacopoeia (USP), ICH, and FDA provide a brief outline of drug substance conditions. The ICH guidelines specifically state^{9, 11}:

Stress testing is likely to be carried out on a single batch of material and to include the effect of temperatures in 10 °C increments above the accelerated temperature test condition (e.g., 50 °C, 60 °C, etc.); humidity where appropriate (e.g. 75% RH or greater); oxidation and photolysis on the drug substance plus its susceptibility to hydrolysis across a wide range of pH values when in solution or suspension.

The degradation samples should be monitored by appropriate HPLC methods for any changes in chromatographic purity profiles as well as for recovery of drug substance. Specified stress conditions should result in approximately 10–20% degradation of the drug substance or represent a reasonable maximum condition achievable for the drug substance. If no degradation is observed under the conditions that will be detailed in this section, it is recommended that stress testing be stopped. The analytical methods developed need to separate degradants observed on stability; therefore, it is critical that the stress-testing model be realistic. Excessive stress will lead to decomposition beyond primary degradation components. This level of stress will cause unnecessary method development for separation of components that will never be observed upon storage according to ICH guidelines. The specific conditions (intensity and length of time) will depend on the chemical characteristics of the drug substance. This guidance pertains to finished drug substance methodologies; however, these studies can be modified for challenge of in-process control methodologies as well.

If there are multiple salt forms or polymorphs being developed in parallel, it is helpful to perform comparative purposeful degradation studies on each form. Additionally, if there are stability issues with a particular salt form, it is advantageous to analyze the salt without drug substance as a control through the method development process as well as the free acid/base form of the com-

pound. These samples can also be used to challenge the stability-indicating nature of in-process control method development.

To get started with purposeful degradation studies, the following parameters are useful. A solubility study for acid/base and oxidation solution studies prevents significant experiment rework (see Section II.B.1 and Section II.B.3 for more details). In terms of quantity of material, the recommended amount needed for experimental purposes is at least 300 mg of drug substance at the early stage of development when there are limited quantities of material and 10–15 g of drug substance at the late stage of development when the supply is not as limited. It is useful to have material manufactured by the proposed commercial process for the more detailed second-generation experimentation in later-stage development. Again, it is critical to have samples representative of what will be observed upon ICH stability guidelines storage.

For the degradation conditions outlined in this chapter, all samples generated should be stored at or below 5 °C to preserve kinetic points until HPLC screening analysis can be performed. Key samples can then be used to optimize the analytical methodologies. It is important that these key predictive samples do not continue to react with time, since this would yield nonpredictive secondary degradants. These additional variables would make method development (especially peak tracking) extremely difficult in the optimization phase (see Section II.D for more details).

Using the conditions and kinetic time point ranges in this guidance, a purposeful degradation study will take approximately 6 weeks. This time frame and number of kinetic points taken can be reduced by a factor of 2 for early-stage work where timelines are typically much shorter.

I. Acid/Base Stress Testing

Acid/base stress testing is performed to force the degradation of a drug substance to its primary degradation products by exposure to acidic and basic conditions over time. Functional groups likely to introduce acid/base hydrolysis are amides (lactams), esters (lactones), carbamates, imides, imines, alcohols (epimerization for chiral centers), and aryl amines.

To initiate acid/base studies, a preliminary solubility screen of the drug substance is performed. Solubility of at least 1 mg/mL in 1 N acidic and 1 N basic conditions is recommended for the acid/base stress testing; however, concentrations less than 1 mg/mL can be used if solubility is an issue. In some cases, a co-solvent may be necessary to achieve the target concentration. Special attention should be given to the drug substance structure when choosing an appropriate co-solvent. One should carefully investigate the chemical composition of the drug substance and take care not to use a co-solvent that may react with it. For example, methanol and other alcohols are avoided for acidic conditions if the compound contains a carboxylic acid, ester, amide, aryl amine, or hydroxyl group. This prevents significant experimental artifact components involving reaction with methanol and other alcohols. Also, 1 N NaOH and acetonitrile are miscible only for solutions containing 20% acetonitrile or less; therefore, the use of acetonitrile as a co-solvent for basic challenges can be problematic.

A stock solution of the drug substance at the appropriate concentration using water and co-solvent (if necessary) is prepared for the set of acid/base hydrolysis studies. This solution is used to prepare the acid and base solutions as well as the drug substance “as is” control. Different co-solvents can be used in the acid and base degradation studies. If the co-solvent is not the same, drug substance “as is” and acid/base control (no drug substance) samples will need to be prepared in each of the solvent systems. For a summary of suggested samples and kinetic points see Table 1.

Acid/base reactions should be initiated at room temperature in the absence of light. Heat should be avoided where possible, because this introduces a second variable. If no degradation is observed at room temperature, then the temperature can be increased. A better understanding of the degradation pathway can be obtained if kinetic points are taken along the course of the acid/base reaction (typically from 0–1 week). If the acid/base reaction proceeds rapidly, it is appropriate to obtain more kinetic points at the start of the reaction. If the 24-h time point shows 10–20% degradation and the primary degradants are understood, there is no need to continue the reaction out to the 1-week point.

By using this acid/base technique, samples can be monitored on-line without the need to quench before HPLC analysis. Kinetic points taken along the reaction pathway are stored at or below 5 °C until HPLC screening is conducted. Often the acid/base reactions proceed too rapidly even at low temperature and a quenching step may be necessary to hold a critical kinetic product distribution. If a quenching step is required, a generic quenching sequence involves the use of 1 equivalent of the conjugate acid or base followed by 2.5 equivalents of ammonium acetate for neutralization. One of the major disadvantages of the quenching step is solubility. If the drug substance is very insoluble at neutral pH, the drug substance may precipitate out of solution in the neutralization step, and as a result, further solubility experiments may be necessary. Therefore, the technique of choice involves on-line HPLC screening of acid/base hydrolysis samples without pH adjustment and only temperature cooling of samples to preserve the kinetic product distribution.

Another critical parameter in the acid/base hydrolysis experiment involves incorporation of the appropriate controls. The critical controls are “as is” drug substance and acid only and base only at an appropriate concentration without the drug substance. Additionally, if elevated temperature is required, a thermal control sample should be run at the reaction temperature without acid

TABLE I Guidance on Acid/Base Experimental Setup

Samples:	Drug substance + acid (1 N HCl)
	Drug substance + base (1 N NaOH)
	Drug substance “as is”
	Acid control (1 N HCl)
	Base control (1 N NaOH)
Kinetic points:	0–1 week

or base to determine whether the degradation observed is the result of thermal or acid/base degradation. If acid/base quenching is involved, the controls should also be quenched.

The acid and base stress conditions should result in approximately 10–20% degradation of the drug substance or represent a reasonable maximum condition achievable. If this level of degradation is not achieved, additional hydrolysis experiments should be performed at no more than 70 °C for a 1-week total reaction time. Going above this level of stress is not recommended for typical drug substance materials. Excessive acid/base stress will produce nonpredictive samples and will lead to unnecessary effort in the HPLC method development.

2. Thermal and Thermal/Humidity Stress Testing

The goal of thermal and thermal/humidity studies is to force the degradation of drug substances over time to determine the primary thermal and/or humidity degradation products. To evaluate stability utilizing elevated temperatures (above the ICH guidelines for accelerated thermal humidity challenges), stress conditions are selected based on a conservative estimate of the Arrhenius expression—a quantitative relationship of reaction rate and temperature [Eq. (3)] using an average activation energy.¹⁵ Based on this estimate, a 10 °C increase in temperature results in a doubling of the reaction rate and a decrease in the reaction time by a factor of 2. Using this rule of thumb, 1 year at 30 °C is equivalent to 3 weeks at 70 °C. As a result, the recommended study length for samples to predict a 2-year room temperature shelf life is 6 weeks at 70 °C (Table 2). This estimate is more likely to be true at or near room temperature.¹⁶ It is also worth noting that increasing the energy of the system may produce products not seen under ICH stability guidelines because there is more energy available to reach activation barriers to products that cannot be formed under ICH conditions. In these cases, it is essential to compare results to ICH stability data and run experiments over a few temperature increments to get a better correlation to ICH stability. Additionally, it is important to determine early kinetic points at 70 °C to get an understanding of the primary degradants.

$$k_{\text{obs}} = A \exp\left(-\frac{E_a}{RT}\right) \quad (3)$$

where k_{obs} is a specific rate constant, A is the preexponential factor, E_a is activation energy, T is temperature in degrees Kelvin, and R is the gas constant (1.987 cal K⁻¹ mol⁻¹).

To perform a 70 °C challenge, an example kinetic pull point setup is executed over a 6-week time frame with more pulls early in the reaction time scale (Table 3). For thermally unstable compounds, the early kinetic points enable the analyst to observe the primary degradation products that may have further converted by the end of the 6-week study. Humidity stress is also factored into this model. The starting stress conditions with humidity levels are 70 °C/30% RH (ambient humidity) and 70 °C/75% RH. These starting conditions are modified if a compound undergoes a change in physical form at or below this elevated temperature. In these cases, significant non-Arrhenius behavior can be observed. Additionally, the stress testing temperatures are significantly reduced

TABLE 2 Guidance for Thermal Stress Length of Study

Temperature	Length of storage
30 °C	1 year
40 °C	6 months
50 °C	12 weeks
60 °C	6 weeks
70 °C	3 weeks
80 °C	11 days

if the pharmaceutical candidate has a low temperature storage recommendation (for example, 5 °C). In this scenario, a more reasonable stress level would be 40 °C.

It is critical to ensure the integrity of the solid samples throughout the study. For example, deliquescence under high humidity conditions is often observed. To detect percent water gain/loss, it is useful to perform gravimetric analysis on all degradation samples. Other methods of water analysis such as Karl Fischer titrimetric determination can also be used (see Section I.B).¹⁰ These methods of analysis can help determine if water has an effect on the degradation mechanism. When these thermal degradation experiments are performed, the neck of each flask should be filled with a cotton plug to avoid problems with condensation entering the vial. The cotton plug is added loosely to allow passage of air into and out of the vial, but tight enough to avoid loss of sample should the vial be accidentally inverted. Water gain/loss data and physical appearance data are key tools for early prediction of formulation stability issues upon ICH stability storage.

According to the thermal/humidity stress testing conditions selected, samples are placed into appropriate ovens. If humidity ovens capable of 70 °C/30% RH and 70 °C/75% RH are not available, saturated salt solutions contained in desiccators can be used to control humidity accurately.¹⁷ These conditions are particularly useful for high-potency drug substance compounds for which samples must be contained. A saturated NaCl solution is used to obtain conditions of 75% RH at 70 °C and a saturated MgCl₂ solution is used to obtain conditions of 30% RH at 70 °C.

TABLE 3 Guidance for Thermal/Humidity Experimental Setup

Samples:	70 °C/30% RH (ambient humidity) 70 °C/75% RH
Time points:	0–6 weeks

3. Oxidation

Oxidative studies are executed to force the degradation of drug substances to determine the primary oxidative degradation products. Oxidative degradation is a serious stability problem and can cause a major halt in pharmaceutical development. The 1987 Stability Guidelines state that a high oxygen atmosphere should be evaluated in stability studies on solutions or suspensions of the bulk drug substance.¹⁸ Drug substance functional groups that are susceptible to oxidation reactions include heteroatoms (nitrogen: *N*-oxides and sulfur: sulfoxides and sulfones), benzylic sites, and aldehydes and ketones.¹⁹

The main source of oxidative degradants for pharmaceutical drug candidates is the reaction of the drug substance and/or drug product with molecular oxygen, a complex reaction.¹⁸ This is a more realistic model than hydrogen peroxide, which is often used in the pharmaceutical industry for oxidative challenge. The major problem with hydrogen peroxide is that it is typically nonpredictive of molecular oxygen reactions. Molecular oxygen is a paramagnetic diradical in its ground state, and the free radical approach outlined herein is a better model for oxidative reactions found in pharmaceuticals. Additionally, it is difficult to quench a hydrogen peroxide reaction mixture. Therefore, the primary oxidation product mixture continues to react, making the sample impossible to use in subsequent method challenges. Furthermore, all quenching methods available incorporate additional stress variables such as acid/base and thermal reflux conditions or addition of catalysts.²⁰ Hydrogen peroxide stress testing can be useful in drug product studies where hydrogen peroxide is an impurity in an excipient. Some pharmaceutical polymer excipients are co-polymerized with hydrogen peroxide and trace peroxide causes oxidation problems.

To prepare for the oxidative degradation study, a preliminary solubility analysis of the drug substance should be performed. The reaction solvent can mimic the proposed formulation. For example, if the formulation has a protic environment, a protic solvent can be selected whereas an aprotic solvent can be selected for an aprotic formulation environment. Acetonitrile is the preferred solvent over methanol because alcohols slow the reaction by competing with the drug for initiator radicals.²¹ Oxidative purposeful degradation studies typically require solubility of approximately 1–10 mg/mL in unbuffered conditions to achieve reasonable levels of degradation. The maximum concentration in this range is recommended since the free radical oxidation process is concentration dependent. A co-solvent may be necessary to achieve the target concentration range.

Our pressurized oxidation approach is run with radical initiators to accelerate oxidation. The process involves a radical chain reaction between molecular oxygen and the pharmaceutical drug candidate, a process known as autoxidation.^{22–24} Key predictive samples with 10–20% degradation are typically generated within 10 days using the addition of 1–10 mole % radical initiator.

The free radical process of autoxidation consists of a chain sequence involving three distinct types of reactions: initiation, propagation, and termination. The initiation produces a free radical to begin the chain reaction.²⁵ Use of a radical chain initiator is a valid method of accelerating autoxidation.²¹

TABLE 4 Diazene Free Radical Initiators for Pressured Oxidation Studies

Chemical Name	Structural Formula	10-Hour Half-Life	Solubility (g/100 g solvent)
2,2'-Azobis(N,N'-dimethyleisobutyramidine) dihydrochloride		44°C in water	35.2 (water)
4,4'-Azobis(4-cyanopentanoic acid)		69°C in water	1 (water)
2,2'-Azobis(2-amidino-propane)dihydrochloride		56°C in water	23.2 (water)
2,2'-Azobis[2-methyl-N-(2-hydroxyethyl)propionamide]		86°C in water	2.4 (water)
2,2'-Azobisisobutyronitrile		65°C in toluene	7.5 (methanol)
2,2'-Azobis(2,4-dimethylvaleronitrile)		51°C in toluene	22 (methanol)

Data source: Wako Pure Chemical Industries.

Table 4 shows example diazenes one can use to accelerate the pressured oxidation reactions for aqueous and organic based systems. The radical chain initiating diazene undergoes thermal bond homolysis to yield two radicals and molecular nitrogen. A hydrogen atom is abstracted from the drug substance or excipient. Radical addition occurs in the initial propagation step of autoxidation (shown in Scheme 2). Molecular oxygen then reacts with the drug substance or excipient free radical at the diffusion-controlled rate of approximately $10^9 \text{ M}^{-1}\text{s}^{-1}$ depending on the solvent system.

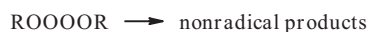
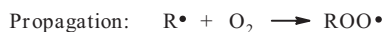
**SCHEME 2** Autoxidation chain reaction.

The propagation sequence continues as a peroxy radical abstracts a hydrogen atom from the drug substance or other organic substrate present such as an excipient in the case of drug product. This rate-determining step, which has a rate constant referred to as k_p , generates a second free radical to propagate the chain and yield a hydroperoxide product. Under these conditions, the rate of oxidation is given by Eq. (4), where k_p and k_t are the propagation and termination rate constants, respectively. R_i is the rate of initiation and $R - H$ is the substrate.

Termination of the autoxidation process occurs as peroxy radicals couple to produce nonradical products. Additional sources of free radicals to initiate the free radical chain process include ultraviolet (UV) light and heavy metals (copper, iron, cobalt, manganese, and nickel) which catalyze oxidation by shortening the induction period and promoting free radical formation.²⁶

$$-dO_2/dt = k_p[R - H] \left(\frac{R_i^{1/2}}{2k_t^{1/2}} \right) \quad (4)$$

To perform an oxidative degradation study, the drug substance is dissolved in an appropriate solvent and transferred to a reaction vessel pressurized at 50–300 psi with molecular oxygen to increase the oxygen solubility in solution. Additionally, the system is heated to accelerate degradation. The temperature depends on the free radical initiator selected (Table 4).

Another variable is the reaction solvent. Oxygen solubility depends on the solvent used in an oxidation reaction. For example, at 0 °C the concentration of oxygen in methanol at atmospheric pressure is 11 times the concentration of oxygen in water. As the temperature is increased to 40 °C, the oxygen solubility in methanol is 21 times greater than that in water.^{27,28} This variable needs to be evaluated during mechanistic studies.

Kinetic points are taken along the reaction pathway and quenched using 1–10 mole % antioxidant. Antioxidants work by consuming oxygen at a faster rate than the drug substance and can compete for free radicals (thus, they are termed free radical scavengers). These antioxidants will protect the drug substance and/or excipients until the free radicals are consumed. The most common antioxidants are ascorbic acid, butylated hydroxyanisole, butylated hydroxytoluene (BHT), and sodium sulfite.^{29,30} The phenolic antioxidants readily react with peroxy radicals to generate a hydroperoxide product and relatively unreactive radical (Scheme 3). Thus, phenolic antioxidants are also excellent hydrogen atom donors. Ascorbic acid and trolox can be used for aqueous based systems, whereas BHT and vitamin E can be used for oxidation performed in organic solvents.^{31–33} The most effective chain-breaking antioxidant among the phenolic antioxidants is α -tocopherol, or vitamin E. Vitamin E is an organic soluble phenolic antioxidant. For aqueous systems, trolox is a better choice for a phenolic antioxidant.³⁴ Because of its chromanol structure, it has effective antioxidant activity and its carboxyl group provides moderate water solubility.³¹

In systems where metal catalysis of oxidation is an issue, the use of a metal chelator such as ethylenediaminetetraacetic acid is recommended to inhibit oxidation. Additionally, as with previous degradation techniques, the oxidation samples should be stored at low temperature (below 5 °C) to preserve the

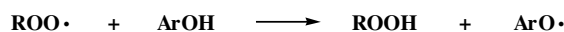

ArOH =

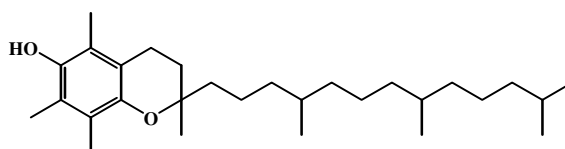

Vitamin E(α -Tocopherol)

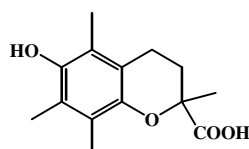

Trolox

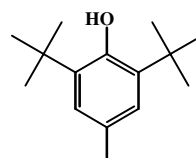

BHT

SCHEME 3 Phenolic antioxidants.

primary oxidative products and prevent them from decomposing further. This will enable continued analysis of the primary oxidative degradants during the method optimization phase of development.

As emphasized in Section II.B.1, it is critical to run the appropriate controls. A thorough experimental design should incorporate the following controls containing the drug substance: oxygen with initiator, oxygen without initiator, argon or nitrogen with initiator (purged of oxygen), and a thermal control (at the reaction temperature). Incorporating the samples outlined in Table 5 will allow easier interpretation of the degradation results and enable one to get a better mechanistic understanding of whether the degradation results from thermal, free radical, or nonfree radical processes. The initiator and antioxidant at appropriate levels without drug substance are other essential controls to run in a method set to determine if any peaks shown in the analytical method result from oxidation reaction compounds that are not drug substance related.

TABLE 5 Guidance for Oxidative Degradation Experimental Setup

Samples:	Oxygen with initiator
	Oxygen without initiator
	Argon with initiator
	Thermal control
	Initiator and antioxidant without drug substance
Time points:	0–10 days

4. Photostability

The goal of the photostability studies is to force the degradation of drug substances via UV and fluorescent conditions over time to determine the primary degradation products. UV and visible light are the most energetic electromagnetic radiation sources to which pharmaceutical drug substances and drug products are typically exposed. A molecule absorbs light when an absorption band exists that overlaps to some extent with the incident light energy and a valence electron in the relevant chromophore is raised to an excited state.³⁵ Light stress conditions can also induce photooxidation by free radical mechanisms. The photo-excited molecule undergoes dissociation and the free radical formed is scavenged by molecular oxygen (see Section II.B.3). The resultant peroxy free radical may then undergo reactions yielding a mixture of oxidized products.³⁵ Functional groups likely to introduce drug photoreactivity are as follows: carbonyl, nitroaromatic, *N*-oxide, alkenes, aryl chlorides, weak C—H and O—H bonds, sulfides, and polyenes.³⁶

There are two types of studies used in pharmaceutical photostability testing: stress testing (purposeful degradation) and confirmatory testing. Purposeful degradation is used to evaluate the overall photosensitivity of the material (unprotected drug substance and drug product) for method development purposes and/or degradation pathway elucidation. Confirmatory tests are used to determine if there is a need to protect the final product from light. The ICH Guideline on Stability Testing of New Drug Substances and Products notes that photostability should be an integral part of stress testing.³⁷ The guideline recommends a systematic approach to photostability testing and lists light sources to be used, which are described below. The only requirements are that the source(s) be continuous over the near UV and visible spectral regions.³⁸

Option 1: Any light source that is designed to produce an output similar to the D65/ID65 emission standard such as an artificial daylight fluorescent lamp, combining visible and ultraviolet (UV) outputs, xenon lamp, or metal halide lamp. D65 is the internationally recognized standard for outdoor daylight as defined in ISO 10977 (1993). ID65 is the equivalent indoor indirect daylight standard. For a light source emitting significant radiation below 320 nm, an appropriate filter(s) may be fitted to eliminate such radiation.

Option 2: For Option 2, the same sample should be exposed to both the cool white fluorescent and near ultraviolet lamp. A cool white fluorescent lamp designed to produce an output similar to that specified in ISO 10977 (1993); and a near UV fluorescent lamp having a spectral distribution from 320 nm to 400 nm with a maximum energy emission between 350 nm and 370 nm; a significant portion of the UV should be in both bands of 320 to 360 nm and 360 to 400 nm. The sample must be exposed to both sources; however, the exposure can be in a sequential or simultaneous set-up.

(*Note:* The ISO 10977 standard contains standard spectral power distributions for these light sources as well as transmission for standard window glass).^{38, 39}

Currently, there are few benchtop systems on the market for small-scale purposeful degradation photostability testing. For option 2, our approach has been to use Rayonet RPR-200 photochemical reactors (SNE Lighting Company) to perform photostability studies. With these reactors, it takes

approximately 1 month to complete a purposeful degradation fluorescent study and approximately 5 days to perform a purposeful degradation ultraviolet study using the stress conditions outlined in this section (see Sections II.B.5 and II.B.6). When separate ultraviolet and fluorescence light testing is performed using the Rayonet RPR-200 photochemical reactor, ultraviolet light bulbs (F8T5/BLB—320–400 nm, maximum 350–370 nm) and fluorescent light bulbs (F8T5/CW—400–700 nm) meet the guidelines specified in option 2 listed above. Additionally, type I class A borosilicate glass vials/test tubes (320 nm cutoff) are useful for fluorescence studies, whereas quartz glass vials/test tubes are useful for ultraviolet studies (185 nm UV cutoff). Quartz is used for ultraviolet studies because type I class A borosilicate glass filters out some of the high-energy UV light from 300 to 340 nm with approximately 80% transmission at 320 nm.

For option 1, stress testing can be performed using an Atlas Suntest Tabletop Sunlight Exposure System (Harris Weathering Products, Inc.). For the Suntest chamber, the total time needed to perform a photostability study can be decreased from 1 month to approximately 5 days. In addition to decreased experiment time, the Suntest system has other advantages over the option 2 method of photostability. An air-cooled xenon source enables more accurate temperature control in the range of 20 to 30°C. In addition, for the region of interest, 300–800 nm, the ultraviolet and infrared radiation have been removed by filters. Also, the output is similar to sunlight (D65/ID65), which is considered to be the worst-case scenario radiation, an ideal photostability stress system. The system meets the requirements of ID65—“indoor standard daylight-behind window glass.” Lastly, the spectral output for the Suntest xenon source also contains the 400 nm gap region left out in option 2.³⁸

The guideline does not recommend one option over the other. Currently, our approach focuses on option 2 to perform purposeful degradation studies as well as the confirmatory testing. Fluorescent lighting is the main lighting in pharmacies, so its use is appropriate. The goal of these purposeful degradation studies is to determine the primary photodegradation products and to generate key predictive samples for HPLC method development and validation. The ultimate goal is to develop photostability-indicating HPLC methods as soon as possible. The remaining portion of the photostability section will focus on option 2 experimentation using a Rayonet RPR-200 reactor. The guideline does give recommendations for sample exposure for confirmatory testing³⁷:

For confirmatory studies, samples should be exposed to light providing an overall illumination of not less than 1.2 million lux hours and an integrated near ultraviolet energy of not less than 200 watt hours/square meter to allow direct comparisons to be made between the drug substance and drug product.

According to the ICH guidelines, “the design of the forced degradation experiments is left to the applicant’s discretion although the exposure levels should be justified.”

The following considerations should be taken into account when planning photostability experiments. One key concern is competing thermal reactions that may complicate photostability purposeful degradation studies. The samples should be irradiated under temperature-controlled conditions to minimize

the thermal variable. The Rayonet RPR-200 photochemical reactor is fan-cooled to $\sim 30^\circ\text{C}$. Therefore, for the Rayonet RPR-200 reactor, foil-wrapped samples are recommended to determine the thermal component of degradation. In stress testing, the samples are placed close to the light source to take advantage of the inverse square dependence of light intensity.³⁸

One other factor of particular concern is sample depth. Photodegradation typically occurs on the surface in the solid state and a thin layer of material works best for forced degradation analysis.³⁸ As per the ICH Guidelines on Photostability Testing, "solid drug substances should be spread across the container to give a thickness of typically not more than 3 millimeters." To perform studies on solid drug substances, the Rayonet RPR-200 reactor is positioned horizontally to get maximum stirring and homogeneous light coverage. Solid samples placed in vials are tumbled to obtain uniform light exposure using the manufacturer's sample rotation device (SNE Lighting Company). For stress testing using a Rayonet RPR-200 reactor, vials to be used should be filled with sample, sealed, and then placed along the length of the vial to measure the sample depth. The depth of the material in the vial should not be greater than 3 mm. If the depth of the material is greater than 3 mm, a vial with a larger diameter or additional vials with the same diameter should be used. Samples should either rotate continuously within the chamber or be removed daily and rotated to obtain uniform exposure.

Light measurements should be taken with an actinometer (visible light measured as illuminance and ultraviolet light measured as irradiance). Actinometry, the calculation of the number of molecules reacted per photon absorbed, is performed with either a physical device or a chemical system. For physical actinometers, it is critical that the actinometer be calibrated for the wavelength region of interest. For example, separate actinometers are required for option 2 (a UV radiometer and fluorescence photometer). International Light manufactures a hand-held actinometer (for example, model IL1400A) with a separate UV attachment (radiometer system) and fluorescence (photometer system) attachment.⁴² The actinometer should be placed so that it is exposed to the same irradiation as the samples. Exposure readings should be taken at the rear, front, right, and left of the Rayonet chamber and averaged for best representation of chamber light intensity. The ICH Harmonized Tripartite Guideline on Stability Testing provides details on a quinine chemical actinometer for monitoring exposure to a near-UV fluorescent lamp.⁴³ It is particularly useful to benchmark the measurements of the quinine system for option 2 UV experiments compared with the radiometer measurements. This can give one an understanding of how well the radiometer has been positioned (a radiometer calibration check). However, this quinine chemical actinometer is not accurate for the fluorescence region for option 2 or for the option 1 xenon light source. A potassium ferrioxalate actinometer solution absorbs photons in the range of 250 to 577 nm, and this actinometer can be applied to fluorescence systems.⁴²

TABLE 6 Guidance for Ultraviolet Degradation Experimental SetUp

Samples:	Ultraviolet Thermal foil-wrapped control
Time points:	5× and 10× ICH*

*Note: ICH ultraviolet conditions = 200 watt h/m².

5. Ultraviolet Exposure

ICH guidelines specify an exposure of 200 watt h/m² for ultraviolet light confirmatory testing (1× ICH). Recommended stress conditions and time points to be tested are 5× and 10× ICH for solid drug substances (Table 6).

All samples should be taken at the appropriate kinetic time points and protected from any further light exposure. Light measurements should be taken in watts/m² to be consistent with the ICH guidelines.

6. Fluorescence Exposure

ICH guidelines specify an exposure of 1.2×10^6 lux hours for fluorescence (1× ICH). Recommended stress conditions and time points to be tested are 5× and 10× ICH for solid drug substances (Table 7).

Filters may be useful to determine any wavelength range causing instability. For example, a 400 nm filter in fluorescence experiments to look at the 400–700 nm component and eliminate the UV portion is especially critical in solution experiments. If photodegradation is observed, one can determine whether it is the result of visible or ultraviolet light using appropriate spectral filters.

C. Drug Product Degradation Studies

Drug product degradation cannot be predicted from the stability studies of the drug substance in the solid state or solution. The nonactive pharmaceutical ingredients (excipients) can also react with the drug substance or catalyze degradation reactions. Impurities in the excipients can also lead to degradation in the drug product not originally observed in the drug substance. For example, when a formulation is exposed to light, other compounds such as

TABLE 7 Guidance for Fluorescence Degradation Experimental SetUp

Samples:	Fluorescence Thermal foil-wrapped control
Time points:	5× and 10× ICH*

*Note: ICH fluorescent conditions = 1.2×10^6 lux hrs

excipients or impurities absorb light to become excited and transfer energy to the drug molecule, leading to photoreaction.³⁸ Purposeful degradation studies are performed to determine the physical and chemical compatibility of the drug substance with excipients. These studies on the drug product depend on the chemical composition of the drug product formulation. For drug product formulations, heat, light, and humidity are often used.⁹ (Although this ICH guideline gives us a starting point, there is no detailed protocol for conducting these method-critical pharmaceutical studies.) This section of the chapter provides such direction.

The drug product stress conditions should result in approximately 10–20% degradation of the active drug substance or represent a reasonable maximum condition achievable for a given formulation. The specific conditions (intensity and length of time) used will depend on the chemical characteristics of the drug product. For all drug product studies, it is critical to run the proper controls: the drug substance, drug product, and placebo. For the most complete understanding of the degradation pathway, all three samples should be taken at each kinetic point and analyzed by the pharmaceutical drug candidate HPLC screening method. In the chromatographic screening of degradation samples, it is extremely useful to use the same methods for drug substance and drug product to allow easier understanding of chromatographic differences.

For drug product, the following key experiments should be considered. These experiments will vary depending on whether the formulation is a solution or solid drug product. For a solid drug product, key experiments are thermal, humidity, photostability (in accordance with ICH guidelines), and oxidation, if applicable. The most common type of interaction in solid dosage forms is between water and the drug substance. Hence, thermal and thermal/humidity challenges are critical¹⁸ (Table 8).

For solution formulations, key experiments are thermal, acid/base hydrolysis, oxidation and photostability (in accordance with ICH conditions). For a solution drug product, more emphasis should be placed on acid/base hydroly-

TABLE 8 Comparison of Drug Substance and Drug Product Degradation Experiments

Condition	Drug substance		Drug product	
	Solid	Solution	Solid (tablets, capsules, blends)	Solution (intravenous, oral suspension)
Acid/base		✓		✓
Oxidative	×	✓	×	✓
Photostability	✓	×	✓	✓
Thermal	✓		✓	✓
Thermal/Humidity	✓		✓	

✓ = recommended; × – optional, suggested for some compounds

ysis. A design involving the drug product typically adjusted ± 1 or 2 pH units around the target pH is acceptable. In addition, earlier time points are required for solution light stability due to the increased rate of reaction in the solution phase. These earlier kinetic time points are generally required in the range of $0-1 \times$ ICH for photostability. Unlike solids and semisolids, stability of drugs in solution can be better predicted and basic kinetic studies can be applied. Semisolids (as oils) are more susceptible to oxidation due to autoxidation of the oil excipients; hence, for these formulations, oxidation is a critical experiment. Drug products that are liquids should be stressed in chemically inert containers. Additionally, effects of actual drug product storage containers should be built into the solution drug product studies since the container is considered to be a part of the formulation. Oxygen permeation is also more significant in plastic than in glass containers; hence, the container should be considered in the drug product design as well.²⁶

In terms of the amount of drug product to be set up, a later-stage study requires approximately 100 tablets (solid) or ~ 1 L (solution). Early-stage work requires approximately 25 tablets (solid) or ~ 50 mL (solution). As outlined in Section II.B, the typical length of a study is approximately 6 weeks. This can be reduced by a factor of 2 for early-stage work (phase I clinical trials) where timelines can be extremely tight.

A final optimized formulation is not necessary to begin purposeful degradation studies. Timing for the final optimized formulation may be too late in development to fully understand the degradation. Early understanding of degradation can be fed back to the formulators for improvement in the formulation before an ICH stability study is well under way and a stability problem is detected. The formulator typically has determined excipients early and is fine-tuning ranges. The purposeful degradation experiments use a formulation that gives the maximum possible excipient/active interactions. This is a designed approach based on the chemical characteristic of the drug substance/drug product.

All excipient chemical reactions should be incorporated into the experimental design. For example, drugs that contain primary and secondary amines functionality undergo Maillard reactions with lactose and other reducing carbohydrates such as glucose and maltose under pharmaceutically "reasonable conditions."^{43, 44} This reaction should be considered during formulation development. Alternative excipients such as mannitol, sucrose, and trahalose, which are not subject to the Maillard reaction, should be used in place of lactose in such cases.

It is key to integrate drug substance and drug product degradation studies, with the drug substance being a critical control for drug product degradation studies. In particular, this aids in the determination of whether a degradant is related to the drug substance or to an excipient. Another point worth noting is to use the same lot of drug substance that is present in the drug product. This minimizes potential variables that can complicate the degradation results. It is critical to look closely at the chemical compositions of the drug substance and drug product. Combinations of excipients that will stabilize a formulation and fail to expose a potential stability problem should be avoided. For example, the two lubricants, magnesium stearate and stearic acid, should not

be combined if basic excipients are problematic and stearic acid acts as a stabilizer. If the amount of material to test is limited or if the final tableting step is rate-limiting, blends can be used to get an initial profile of the stability. Lead and backup formulations can be examined as well to obtain comparison data on formulation stability. These results can be communicated back to the formulation group before the nomination of the final clinical or commercial dosage form (depending on the stage of development). Therefore, these early drug product degradation studies can have significant time- and cost-saving implications for a pharmaceutical development project.

D. Degradation Prediction

Degradation prediction is extremely helpful for understanding a degradation mechanism. One program that has been particularly useful is CAMEO (computer assisted mechanistic evaluation of organic reactions).⁴⁵ CAMEO is a computer program that predicts the products of organic reactions given starting materials, reagents, and conditions. The analyses cover the key degradation conditions, basic/nucleophilic, acidic/electrophilic, radical, oxidative/reductive, and photochemical, as well as mechanistic interpretations of these reactions. The CAMEO prediction results should be used as an initial guide to possible decay products that may form at a given condition. The interpretation should not be that all the CAMEO decay products listed will actually be observed during stability studies, nor should one expect that CAMEO will predict all degradation products that will actually be observed in these studies. In general, the CAMEO algorithms have been designed to give product mixtures that err on the conservative side. This is preferable to rules that are too restrictive and reject a key product observed in actual degradation or ICH stability studies. It is also likely that certain products predicted can undergo further decomposition. For example, primary and secondary hydroperoxides typically undergo further radical termination reactions in actual degradation studies to produce nonradical termination products such as ketones and alcohols. Overall, these CAMEO-predicted degradation products assist in the degradation characterization studies that will be outlined in the following sections of the chapter.

E. Key Degradation Samples for Method Development

One of the most difficult tasks of analytical method development is the determination of which chemical entities a method needs to separate and quantitate. Often the list of necessary separations grows throughout the method development process, and analysts are forced to constantly redevelop the analytical assay each time a new impurity is introduced. If the separation goals are determined at the beginning of the method development process, duplication of effort can be minimized.

As emphasized in Section II.A, a proactive approach to HPLC method development should involve purposeful degradation at the early stages of development with the key degradation samples used in the method development process. See Figure 6 for an overview of the role of purposeful

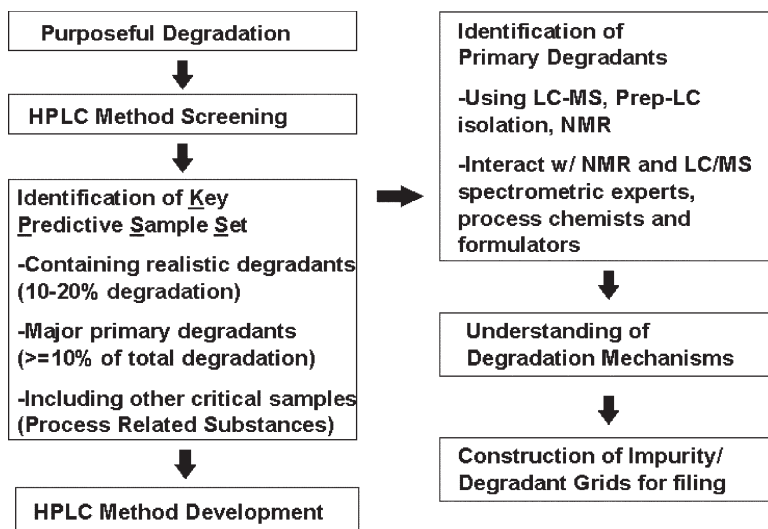

FIGURE 6 Flow chart for the proactive role of purposeful degradation as an integral part of the method development process.

degradation in method development. As shown, purposeful degradation should be the first step in method development. If degradation is performed early, method development and identification of primary degradation products and unknown impurities can be run in parallel. By using this process, a validated HPLC analytical assay, mechanisms of degradation, and the impurity/degradant grids for filing can all be generated without delays in the project timeline.

When degradation samples are generated and evaluated at early stages of method development, the current HPLC methodology should be used to initially determine the potency (assay value) and purity profile (area percent of degradants). These analyses allow the analyst to obtain mass balance data and a better understanding of the level of degradation occurring. Mass balance is defined in the 1999 ICH Guidelines as “adding together the assay value and levels of degradation products to see how closely these add up to 100 percent.” The guidelines recognize that it can be difficult to determine mass balance due to unknown analytical precision and differences in response factors. This approach would allow the analyst to detect any solubility issues (lower assay values when compared to the purity of the drug substance determined by area percent) early in the process. After this preliminary evaluation, key degradation samples can be analyzed by multiple screening assays, which may include HPLC gradient methods, variation of organic modifiers, variation of pH, and screening of the main band by photodiode array analysis and liquid chromatography LC–MS. The USP echoes this approach in suggesting that “Peak purity tests (e.g., using diode array or mass spectrometry) may be useful to show that the analyte chromatographic peak is not attributable to more than one component.”¹⁰

The key degradation–impurity sample set for a given compound is equal to the degradation key sample set plus the process-related impurity sam-

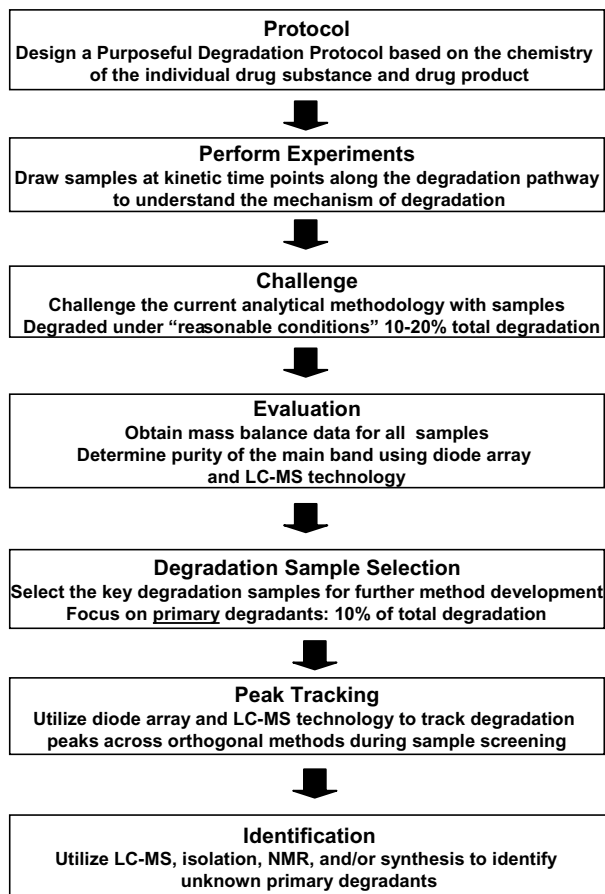

FIGURE 7 Flow chart for the key predictive sample set selection process.

ple set, which can include impurities, intermediates, and starting materials. Typically, process-related impurities and known degradation products are available as reference standards for use in method development. Unknown degradation products can also be key in the development of a stability-specific method.

The focus should be on primary degradation products. Primary degradants are usually greater than or equal to 10% of the total degradation. Any degradation sample containing one or more unidentified primary degradation products greater than or equal to 10% of the total degradation is considered to be a degradation key sample. Figure 7 details the process involved in generation and selection of the key degradation-impurity sample set. For example, if an analyst observes 10% total degradation of the active drug compound, all degradants at or above 1% should be tracked. Work is then performed to identify the unknown primary degradants. The integrity of these analyte peaks can be verified by LC-MS selective ion monitoring. The purity of the peaks can also be verified by collecting the peak of interest and chromatographing it by another method [thin-layer chromatog-

raphy (TLC), GC, or a second HPLC system]. If the peak is collected and chromatographed by another system, the peak should appear as a single peak/spot.⁴⁶

Usually key predictive samples can be generated on a large-scale basis for preparative isolation. Small-scale synthesis is also an option when a likely structure is identified and the chemical synthesis can be accomplished in a few short steps (see Section III).

F. Global Perspective of Degradation and Impurity Process

Figure 8 displays where purposeful degradation studies, method development, and unknown identification fall in the global perspective of analytical compound development. Identification of the degradation sample set leads to understanding of degradation mechanisms. Along with process-related impurities/intermediates and knowledge of the drug substance synthesis and drug product formulation, this understanding provides for rational development of chromatographic methods and understanding of the chemical characteristics of the process. The sequence of studies and the knowledge gained enable the development of a rationale for regulatory specifications, provide understanding of stability studies, and assist with packaging strategies and creation of impurity grids for filing. Figure 8 is derived from the suggestions put forth in the ICH Draft Consensus Guidelines: Impurities in New Drug Substances and Impurities in New Drug Products^{47, 48}:

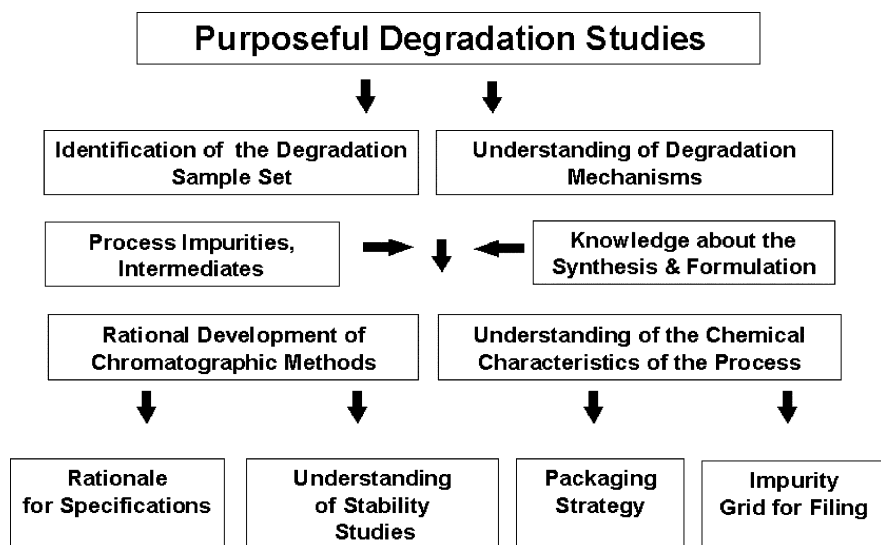

FIGURE 8 Global perspective of the purposeful degradation, identification, and method development process.

Drug Substance:**Section 3. Rationale for the Reporting and Control of Impurities**

The applicant should summarize those actual and potential impurities most likely to arise during synthesis, purification, and storage of the new drug substance. This summary should be based on sound scientific appraisal of the chemical reactions involved in the synthesis, impurities associated with raw materials which could contribute to the impurity profile of the new drug substance, and possible degradation products. This discussion may include only those impurities that may reasonably be expected based on knowledge of the chemical reactions and conditions involved.

The applicant should summarize the laboratory studies conducted to detect impurities in the new drug substance. This summary should include test results of batches manufactured during the development process and batches from the commercial process, as well as results of intentional degradation studies used to identify potential impurities arising during storage.

Section 5. Reporting Impurity Content in Batches

Analytical results should be provided for all batches of the new drug substance used for clinical, safety, and stability testing, as well as for batches representative of the proposed commercial process. The content of individual identified and unidentified, and total impurities, observed in these batches of the new drug substance, should be reported with the analytical procedures indicated. A tabulation (e.g., spreadsheet) of the data is recommended.

Drug Product:**Section 2.2. Rationale for the Reporting and Control of Impurities**

The applicant should summarize those degradation products observed during stability studies of the Drug product. This summary should be based on sound scientific appraisal of potential degradation pathways in the Drug product and impurities arising from the interaction with excipients and/or the immediate container/closure system. In addition, the applicant should summarize any laboratory studies conducted to detect degradation products in the Drug product. This summary should include test results of batches representative of the proposed commercial process. A rationale should be provided for exclusion of those impurities which are not degradation products, e.g., process impurities from the drug substance and excipients and their related impurities.

Federal regulations require more from the pharmaceutical industry than just reporting that impurities and degradation products may exist. The 1987 FDA Stability Guideline gives guidance on the procedure to follow when degradation products are detected¹¹:

The following information about them should be submitted when available:

- Identity and chemical structure.
- Cross-reference to any available information about biological effect and significance at the concentrations likely to be encountered.
- Procedure for isolation and purification.
- Mechanism of formation, including order of reaction.
- Physical and chemical properties.
- Specification and directions for testing for their presence at the levels or concentrations expected to be present.
- Indication of pharmacological action or inaction.

Section III will detail the process for effectively isolating, purifying, and identifying the impurities and primary degradation products in bulk drug substance and drug product formulations.

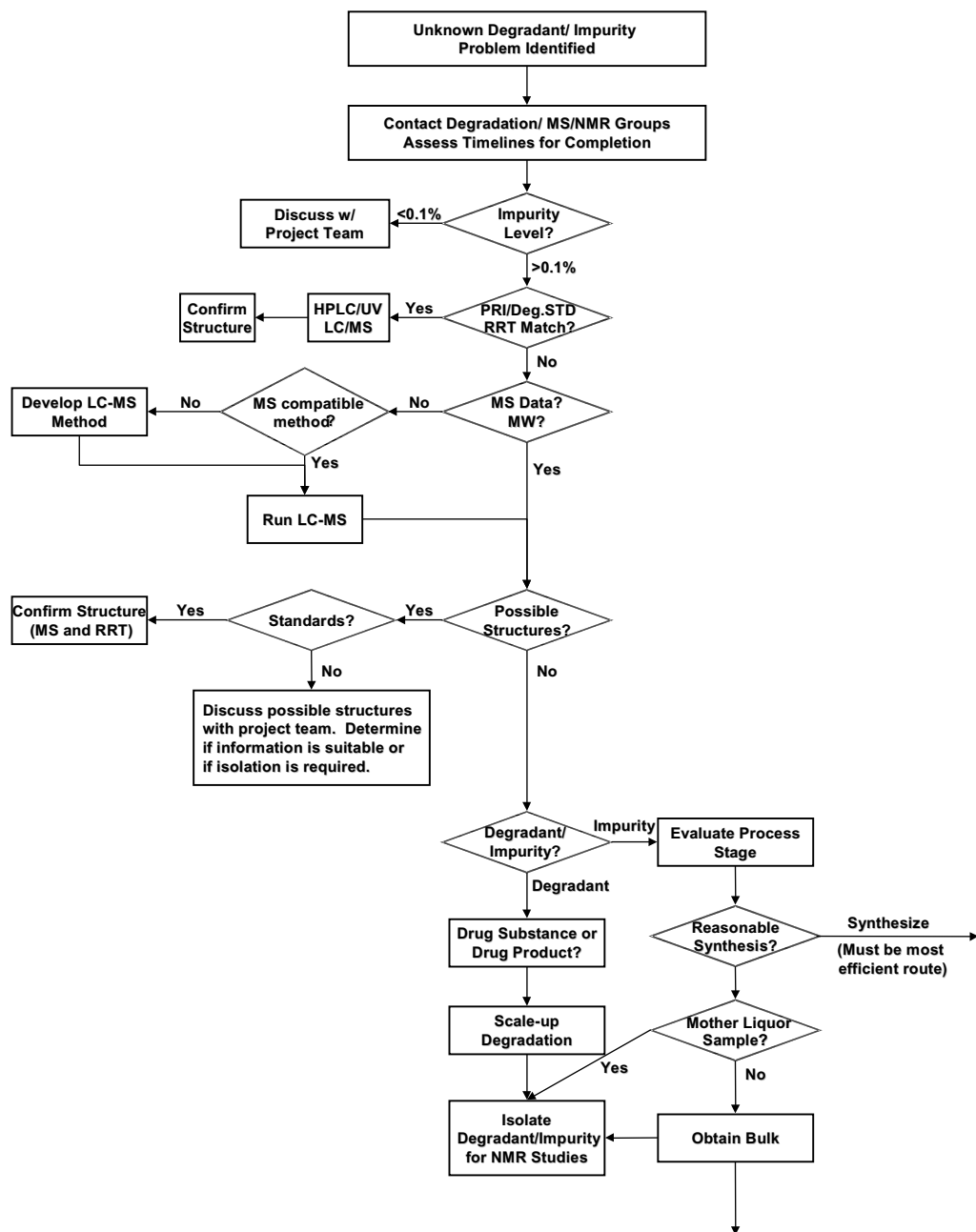

FIGURE 9 Impurity/degradant isolation and identification process flow chart. PRI, process-related impurity; STD, standard; RRT, relative retention time; MWV, molecular weight.

III. ISOLATION AND IDENTIFICATION OF IMPURITIES/DEGRADANTS

A. Introduction

The objective of this section is to provide guidance for isolating and identifying process-related impurities and degradation products from pharmaceutical drug candidates. The identification of degradation products can provide an understanding of impurity formation and define degradation mechanisms. If the identification process is performed at an early stage of drug development, there is adequate time for improvements in the drug substance process and drug product formulation to prevent these impurities and degradants long before the filing stage. Impurity and degradant structure elucidation is a collaborative effort involving the analytical chemist, process chemist, and/or formulator as well as the degradation, mass spectrometry, and NMR experts. The process described in this section uses a designed approach for impurity and/or degradant identification, which focuses on efficiency so that the success of data collection is maximized. There are a number of activities other than collecting experimental data, even though the experiments are central to the process. The activities associated with this work are captured in the process flow chart provided in Figures 9 and 10.

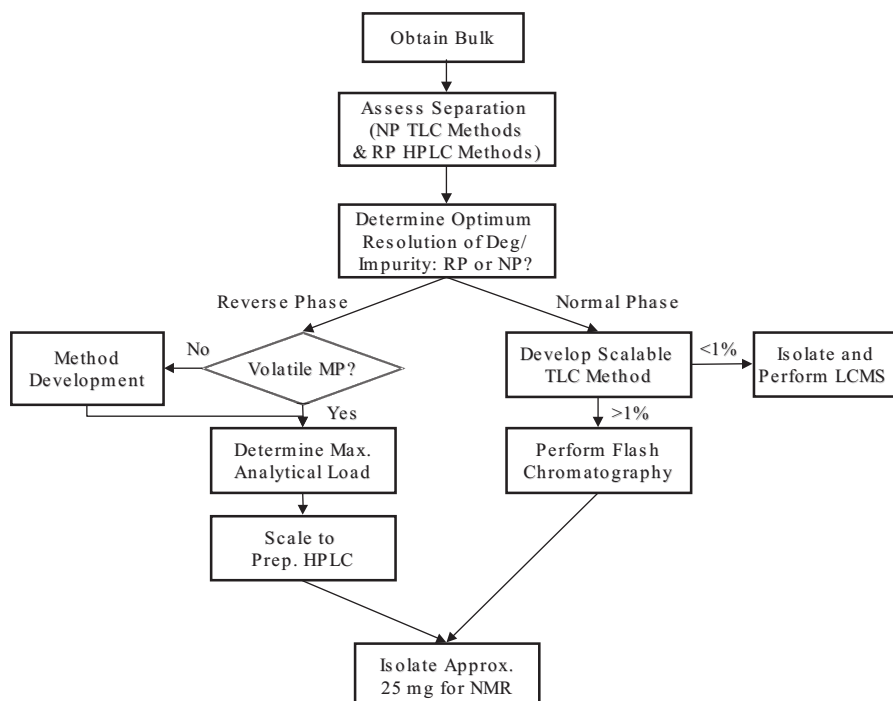

FIGURE 10 Impurity/degradant isolation and identification process flow chart (continued). RP, reverse phase; NP, normal phase.

B. The Process

The process of identification of impurities and/or degradants begins early in drug development. Early brainstorming sessions should involve the analytical chemist, the process chemist, the formulator, and the degradation chemist, as well as the mass spectrometry and NMR experts. It is imperative that all those who are familiar with the project of interest are involved. The group meets to assess the timelines for completion and to gather all pertinent information. A few questions that need to be answered at this early stage are: Is this an impurity or degradant problem? At what level is the impurity/degradant present? Is it a process-related impurity, and, if so, at what step of the process is it formed? Is it a degradant, and, if so, under what degradation condition is it formed? Are enriched samples with the unknown impurity/degradant available? By gathering all relevant information, the most efficient method of isolation and identification can be selected.

The first step of the process is to determine the level of the unknown compound. According to the ICH Guidelines on Impurities in New Drug Substances⁴⁷:

The studies conducted to characterize the structure of actual impurities present in the new drug substance at a level greater than 0.1% (depending on the daily dose, calculated using the response factor of the drug substance) should be described. Note that all specified impurities at a level greater than the identification threshold in batches manufactured by the proposed commercial process should be identified.

Degradation products observed in stability studies at recommended storage conditions should be similarly identified. When the identification of an impurity is not feasible, a summary of the laboratory studies demonstrating the unsuccessful effort should be included in the application.

According to the ICH Guidelines on Impurities in New Drug Products⁴⁸:

Degradation products observed in stability studies conducted at recommended storage conditions should be identified when present at a level greater than the identification thresholds (1% for a maximum daily dose of <1 mg to 0.1% for a maximum daily dose of >2 g).

Identification of impurities below the 0.1% level is generally not considered to be necessary unless the potential impurities are expected to be unusually potent or toxic.⁴⁷ Therefore, it is imperative to determine the level of the unknown impurity and/or degradant early in the process. If the level is below the 0.1% threshold, then the project team members will need to discuss whether isolation and identification are necessary. However, if the level is at or above the 0.1% limit, then effort should be put forth to identify it.

Once a decision has been made to identify an unknown compound, the next logical step is to evaluate all known process-related impurities, precursors, intermediates, and degradation products. By observing the relative retention times (HPLC) of all known process-related impurities, precursors, and intermediates (if available), one can quickly determine whether or not the impurity of interest is truly unknown. If the relative retention time of the unknown impurity matches that of a standard, then it can be identified using HPLC (with UV photodiode array detection) and LC-MS. The identity is confirmed by correlating the retention time, ultraviolet spectra, and mass spectra of the unknown impurity with those of the standard.

Identifying an unknown impurity by using a standard, as described in the above paragraph, is a quick and easy process. What happens when the relative retention time does not match that of a standard? The next step is to obtain molecular mass and fragmentation data via HPLC–MS. It is essential to determine the molecular mass of the unknown impurity. Not only does the molecular mass help in the identification of the unknown impurity, but it also enables one to track the correct peak by HPLC if isolation becomes necessary. To run LC–MS, a mass spectrometry-compatible HPLC method must be available. The mobile phase should contain volatile buffers that are HPLC–MS-compatible (see Section IV.D.2). If such a method is not available, then one must be developed, which adds time to the identification time frame.

If the mass spectrometry data evaluation yields sufficient structural information, this eliminates the need to isolate the impurity in question. If standards for the proposed structures are available, they can be correlated with data for the unknown compound as previously described. If standards are not available, which is usually the case, the proposed structures can be discussed with the project team. The project team can then decide if the information is suitable for their needs, or if isolation is required.

An alternative to isolation is small-scale synthesis. If possible structures have been proposed from the mass spectrometry data, one can study the chemical process and determine at which step of the process the impurity and/or degradant is most likely to be formed. By knowing the chemical process, the feasibility of the proposed structures can be evaluated. Proposed structures can then be synthesized if a reasonable synthesis method is available. It is easier to synthesize and identify an unknown compound if the chemical process works quickly (i.e., one step/straightforward process). The synthesis must be the most efficient route.

At this stage of the process, it is frequently necessary to isolate and characterize the unknown compound. One of the most important factors to consider when approaching an isolation experiment is the origin of the sample. It is vital to determine whether the unknown is an impurity and/or degradant. Because isolating low-level impurities can prove to be very cumbersome and time consuming, the ultimate goal is to find a sample that contains an enriched quantity of the unknown. Two great resources for enriched samples are retained mother liquor samples and purposeful degradation/stability samples. If the unknown compound is a drug substance degradant, then the degradation reaction can be scaled up to generate a large quantity of it. If it is a drug product degradant, then effort should be put forth to form the degradant in the drug substance so that extraction from the excipients is not required. Whenever enriched samples are not available, the unknown compound must be isolated from the bulk drug substance or drug product.

A number of methods can be used for isolating impurities and/or degradants. Three of the most utilized techniques are TLC, flash chromatography (column chromatography), and preparative HPLC. The actual technique used depends upon the nature of the impurity and/or degradant, including the amount present in the original material from which it must be isolated. A good starting point is to assess the separation that is currently being used by the analytical chemist. Does the current methodology provide optimum reso-

lution of the impurity/degradant from the main band and other impurities, and if so, is that method TLC or HPLC? This is a key factor in determining which technique to utilize. Each of the three techniques will be discussed separately.

C. Isolation Techniques

I. Thin-Layer Chromatography

TLC is a good technique to use when normal-phase solvents provide optimum separation. Typical thin-layer separations are performed on glass plates that are coated with a thin layer of stationary phase. The stationary phases used in TLC encompass all modes of chromatography including adsorption, normal- and reverse-phase, ion-exchange, and size-exclusion.⁴⁹ The equipment required is simple and inexpensive. TLC is an ideal technique for the isolation of compounds because of its simplicity. However, for TLC to be successful, the impurity and/or degradant level should be at or above 1%. Any component present below this level is very difficult to isolate on a TLC plate because of higher detection limits.

The steps involved in preparative TLC are (1) application of the sample onto the plates, (2) development of the plates, (3) detection and location of the compound of interest, and (4) extraction of the compound of interest. Detection is usually by ultraviolet light. When the separated compound of interest is located on the plate, the band is scraped and the impurity is extracted from the stationary phase (i.e., silica gel) with an appropriate solvent. The extracted material is filtered or centrifuged, and the solvent collected is evaporated to yield the isolated material. It is essential to remove silica gel and other interferent that may inhibit the identification of the compound. The isolated material is submitted for LC-MS analysis.

One of the main disadvantages of using TLC for preparative isolations is that limited amounts of material can be isolated from the plates. Using preparative TLC plates can circumvent this problem. Preparative plates contain thicker films of stationary phase, thus allowing larger amounts of sample to be applied. Even in cases where preparative plates are used, chances are good that not enough material can be isolated for traditional NMR analysis (including ¹H and ¹³C NMR). Therefore, TLC is most useful when an impurity and/or degradant can be identified by LC-MS. If NMR analysis is essential for identification, flash chromatography or preparative HPLC is a more suitable technique.

2. Flash Chromatography (Column Chromatography)

When an existing normal-phase TLC method provides adequate resolution of the impurity/degradant to be isolated, then flash chromatography can be a useful technique. Flash chromatography is a simple adsorption chromatography technique for the routine purification of organic compounds. It allows for separations of samples weighing 0.01–10.0 g in 10–15 min.⁵⁰ Flash chromatography is a rapid, inexpensive, and easily performed technique with a large sample capacity (approximately 5 times the load of reverse-phase packing materials). Normal-phase flash chromatography is ideal when the sample is

soluble in nonpolar or moderately polar solvents such as hexane, chloroform, and dichloromethane. These solvents allow easier concentration of impurities and degradants. Before choosing flash chromatography as the separation technique, use knowledge of the chemical composition to assess the potential stability of the product before isolation to determine if special collection conditions are necessary. For example, collect thermally unstable products in chilled flasks.

The first step in developing a flash chromatographic separation is to determine the optimum solvent composition by analytical TLC. A solvent system is chosen that provides good resolution and moves the desired impurity and/or degradant to $R_f = 0.35$.⁵⁰ TLC can provide a guide to suitable solvent systems, but development work may be needed to optimize the separation when it is scaled up to columns with larger inside diameters that are used in flash chromatography. A suitable column is selected based upon the resolution of the impurity and/or degradant and the amount of sample to be purified. The amount of sample that can be purified on a column depends on the resolution of the impurity and/or degradant, and it is proportional to the cross sectional area. If less resolution is required to separate a key degradant or impurity, sample load can be significantly increased. Typically, each run on a flash column can chromatograph gram quantities of material depending on the column size. The column load is much higher than that of reverse-phase chromatography.

The columns are generally packed with silica gel. For the separation to be successful, the size of the silica gel particles should be 40–63 μm .⁵⁰ A concentrated solution of the sample is prepared. The sample solution is applied at the top of the column, and the walls of the column are washed with a few milliliters of eluent. Solvent is added to the column, and air pressure is applied at a flow rate of 2 in./min to rapidly elute the desired impurity and/or degradant. Separation is based upon the differential interactions between the solute molecules and the adsorbent surface of the silica gel. Fractions are continuously collected and monitored by chromatographic techniques (HPLC with UV detection, GC, or TLC). The fractions containing the compound of interest are combined and evaporated to dryness. The isolated material is cleaned (post isolation cleanup, such as small-scale column or analytical HPLC reinjection, is essential) and submitted for LC–MS and NMR analysis.

Flash chromatography is a fast and inexpensive technique for isolations requiring only moderate resolution.⁵⁰ Typically, compounds having $R_f \geq 0.15$ can be cleanly separated using this technique, and separations at $R_f \cong 0.10$ are possible. If high resolution is required, flash chromatography can be used as a preliminary purification step. It can be a good method of concentrating and partially purifying complex mixtures, thus making the final isolation by preparative HPLC much easier. For example, the main band can be isolated from the rest of the mixture; therefore the impurity mixture needing optimum resolution can be injected with higher load on HPLC. In addition, automated flash chromatographic systems with UV detectors and fraction collectors are available that further simplify the isolation process.

3. Preparative HPLC

Preparative chromatography is the process of using liquid chromatography to isolate a sufficient amount of material for other experimental or functional purposes. This section describes the use of preparative HPLC to isolate tens of milligrams of pure unknown compound(s) for the purpose of structure elucidation by spectroscopic techniques, which is often referred to as semipreparative HPLC. This section will focus primarily on preparative HPLC methods with the following parameters:

<i>Column length:</i>	15–50 cm
<i>Column width:</i>	10–40 mm
<i>Particle size:</i>	5–60 μm
<i>Column load:</i>	10–1000 mg
<i>Flow rate:</i>	5–100 mL/min

The scale of preparative HPLC is normally larger than that of conventional HPLC. Therefore, a practical starting point is to develop an analytical separation that optimizes the isolation conditions. Optimization of the analytical method implies seeking conditions that combine maximum resolution of the peak of interest and minimum elution time, under the restriction of a limited pressure drop.⁵¹ The optimized conditions determine the column, mobile phase, flow rate, and sample loading capacity for the particular column. The conditions may be either normal phase or reverse phase. The mobile phase should be chosen carefully to avoid salt complexation with the compound to be isolated. Volatile acid salts such as trifluoroacetic acid, formic acid, and acetic acid are acceptable mobile phase additives, and the ammonium counterion is preferred for pH adjustment to any of these acids.

Once the analytical scale method conditions are optimized, the next step is to choose a column and scale up the analytical HPLC parameters so that preparative chromatography can be performed and the unknown compound(s) can be isolated for identification by MS and NMR. For ease of transition, a preparative column consisting of the same packing material and particle size should be chosen. The column is the most important component of the process because it determines the amount of material that can be loaded for the desired purity and recovery. An important step in the scale-up procedure is determining the maximum load on the analytical column. The maximum analytical load is essential in determining the loading capacity of the preparative column. When an appropriate column is chosen, the analytical isolation can be scaled up using Eq. (5)⁵²:

$$\text{Scale up factor} = \frac{(D_p)^2 \times L_p}{(D_a)^2 \times L_a} \quad (5)$$

where D_p is diameter of the preparative column, D_a is diameter of the analytical column, L_p is length of the preparative column, and L_a is length of the analytical column.

The scale-up factor is used to predict how much material can be loaded onto the preparative column and what the flow rate should be. For example, if a separation optimized on a 4.6×150 mm column was scaled to a 20×300 mm column, the scale factor for the sample load would be 38. Thus,

the scale-up factor multiplied by the maximum analytical load estimates how much material can be loaded on the preparative column [see Eq. (6)]⁵²:

$$M_p = M_a \times \frac{(D_p)^2 \times L_p}{(D_a)^2 \times L_a} \quad (6)$$

where M_p is the maximum mass load on the preparative column and M_a is the maximum mass load on the analytical column.

To maintain the same resolution when scaling-up a method, the flow rate also needs to be scaled proportionally. The preparative flow rate can be estimated by using the scale-up factor. For this estimation, the scale-up factor is multiplied by the analytical flow rate to estimate the preparative flow rate [see Eq. (7)]⁵²:

$$F_p = F_a \times \frac{(D_p)^2 \times L_p}{(D_a)^2 \times L_a} \quad (7)$$

where F_p is the preparative flow rate and F_a is the analytical flow rate.

YMC Inc. has simplified the process of scaling up an analytical separation for preparative isolation by developing matched R&D column sets.⁵² Each R&D column set contains an analytical methods development column and a preparative isolation column packed from the same lot of packing material. This provides assurance that any separation developed on the analytical column will scale-up directly on the matched preparative column without further method modification. The use of these column sets eliminates potential selectivity differences caused by different types of silica and different particle and pore size packings by providing matched columns.

When the preparative method has been optimized, injections are made and the compound of interest is collected using a fraction collector. The fractions are pooled together in a collection vessel. The stability of the isolated product should be assessed before isolation to determine if special collection conditions are required. In addition, be sure to use clean glassware. Contamination can occur if the glassware has not been thoroughly cleaned. Also, carefully select the tubing used for collection of the unknown (i.e., avoid using Tygon tubing because it contains phthalates). The isolated product is concentrated using conventional sample concentration techniques (i.e., distillation at normal or reduced pressure, precipitation, freeze-drying, solvent extraction, and membrane filtration). Rotary evaporation and flash distillation are the two most commonly used techniques to recover isolated products from the mobile phase.⁵³ After the product has been recovered, it should be dried under high vacuum to remove all solvents.

An analytical cleanup of the isolated sample is critical before NMR analysis. A clean sample improves the quality of NMR data. As was mentioned earlier, volatile acid salts such as trifluoroacetic acid, formic acid, and acetic acid are often used as mobile phase additives, which may cause salt formation if the pH of the mobile phase is adjusted (i.e., using ammonium hydroxide). In addition, mobile phase solvents may also contain low-level impurities that become enriched during the concentration process. It is essential to remove any salts and/or impurities from the isolated product. A simple way to purify the isolated product is to reinject it onto the preparative column using a mobile

phase without any additives or pH adjustments. By utilizing gradient elution, salts can be removed by incorporating an aqueous rinse at the beginning of the run, and then the solvent can be ramped to elute the desired product. Thus, the isolated peak is purified. Solid-phase extraction also offers great potential for purifying the isolated product because of its universality.⁵³ Washing the isolated sample with deuterated solvent several times also helps to prepare the sample for NMR. Once the sample has been purified, it is submitted for LC-MS and NMR analysis.

As was mentioned earlier, isolation of low-level impurities and/or degradants can be cumbersome and time consuming. Consider a 0.1% level impurity present in a drug substance bulk lot. Based on traditional NMR experiments (see Section V), 5 mg of the impurity would be needed to obtain structural confirmation. To isolate 5 mg of the impurity from the bulk, a minimum of 5 g of bulk drug substance would be needed, assuming 100% recovery. Because actual recoveries are generally closer to 50% for low-level (0.1% range) isolations, 10 g of bulk drug substance would generally be requested.

In addition to requiring significant bulk material, the time frame to complete the isolation is considerable. If the maximum analytical load for a 4.6×150 mm column has been determined to be 5 mg, assuming the isolation will be performed using semipreparative chromatography (20×300 mm column), approximately 190 mg of sample can be loaded onto the preparative column. For a 0.1% level unknown, this translates to 190 μ g of sample injected onto the preparative column. Therefore, a total of 27 injections are required. If the assay time were estimated to be 1 h, it would take at least 27 h to perform the injections needed to obtain 5 mg (once again assuming 100% recovery). This time frame does not include the time needed for method scale-up development, concentration and solubility experiments, and mass spectrometry and NMR experimentation.

On the other hand, if a sample was available that contained 10% of the unknown compound, only 1 g of bulk would be needed and the estimated time frame of the isolation would be drastically reduced. In the example above, 19 mg of unknown compound can be injected onto the preparative column (assuming the maximum analytical load does not change and resolution is retained with the higher level impurity). Therefore, only one injection would be needed to obtain the amount necessary for NMR analysis, reducing the time to 1 h.

Most of the applications discussed in this section deal with semipreparative HPLC columns. Preparative HPLC is also becoming increasingly important in production-scale separations and purification. A major problem in the scale-up of HPLC equipment to the production scale is the loss of column efficiency that occurs when small particles are packed in large-diameter columns.⁵⁴ A major problem of large-diameter columns is column stability. As the column diameter increases, the chromatographic bed becomes unstable because of the loss of wall support. The particles can reorganize and the whole bed settles, usually forming a void at the column inlet. In preparative columns the wall can be very far away from the center of the column, and the central part of the bed is not stabilized. Therefore, for larger columns (generally >50 mm inside diameter) it is often necessary to provide a mechanical means to prevent the bed

from collapsing or rather to eliminate the effects of this collapse.⁵⁵ Compression techniques have been developed to solve this problem. These techniques include radial and axial compression. For small-particle production-scale preparative HPLC with long column life expectancy, compression is needed not only for packing, but also during chromatography.⁵⁶

Radial compression uses radial pressure applied to a flexible-wall column to lessen wall effects. The mobile phase has a tendency to flow slightly faster near the wall of the column because of decreased permeability. The solute molecules that happen to be near the wall are carried along faster than the average of the solute band, and, consequently, band spreading results. Preparative scale radial compression chromatography columns have been found to possess efficiencies close to those of analytical-scale columns when an adequate radial compression level is used.^{54,57} Radial compression technology also helps lower the cost by substituting reusable column holders in place of expensive steel columns.

Axial compression can be exerted from above with an adjustable column head or from the bottom with a fixed piston. Dynamic axial compression (DAC) is a column design in which a piston is used to pack and unpack the chromatographic bed and maintain bed compression during use.⁵⁵ The DAC approach is powerful and convenient because it allows users to pack their own columns very easily. Also, because the compression is maintained continuously during column operation, the bed structure is very stable. DAC technology makes scale-up a straightforward operation by generating large-diameter columns with plate numbers comparable to those obtained with analytical columns.

IV. MASS SPECTROMETRY IN IDENTIFICATION OF IMPURITIES

A. Introduction

Mass spectrometry, by itself and in various combinations with other analytical instrumentation, is the first logical technique to use to probe unknown structures. It is a structurally sensitive technique, giving the potential of molecular mass and structure-indicating pieces of information in one observation. Coupled with chromatography, it provides orthogonal chromatographic retention time information to support any assumptions of purity and provides clues to identity from retention time behavior. It is a quantitatively sensitive technique. The amplitude of the signals directly represents the amount of material introduced into the instrument over a relatively wide dynamic range. Mass spectrometry requires small amounts of sample to obtain significant amounts of structural information on the target compound.

Mass spectrometry is, however, a destructive technique—it consumes sample, albeit very small amounts. It is not a universal detector. There are entire classes of compounds that respond differentially in the mass spectrometer under varied conditions, poorly in general, or not at all. The inference of structure from mass spectra is also highly empirical. Regardless of effort, the theoretical prediction of the mass spectrum from a given structure has not been

perfected. One is obliged to compare the behavior of known structures with unknowns. This must be done very carefully. The structure that is inferred from a mass spectral study is often not complete. Although mass spectrometry is a powerful structure elucidation tool, its use is not without risk. MS should always be used in conjunction with other techniques and good chemical sense.

The most important concept to remember when evaluating the value of mass spectrometry—or of any analytical technique—is what the technique cannot tell one about the problem. This is just as important as what the technique can tell one about the problem. It is vital not to mislead oneself by thinking that the technique under consideration can address the problem when it really cannot.

B. The Process

How does one logically proceed after deciding that mass spectrometry is an appropriate technique to use? Figure 11 maps the logic we use most often to investigate a structure identification problem. The history of a problem is collected, the most appropriate samples are identified, and the necessary supporting methods are assembled—e.g., for an LC–MS experiment, an LC–MS compatible assay that separates the components of interest is identified. Any decision regarding “confident answers” implies that the experiments have provided clear answers, such as clear molecular mass and fragmentation observations that are reproducible. It is essential to convince oneself that the facts are correct before expending effort to try to interpret those facts.

Comparison of the observed behavior of the unknown compound with that of the parent drug substance is often helpful. (It is essential to have prior characterization of the parent drug substance so one knows how the structure class behaves.) Simple differences between the behavior of the parent molecule and of the impurity will suggest obvious structures. For example, a difference of 14 Da suggests a change in hydrocarbon chain length or the presence of a methyl ester. An increase of 16 Da suggests oxidation. A loss of 18 Da suggests dehydration. These simple “magic number” differences will often give immediate answers. In our environment, such simple variants are often available for comparison or can be easily synthesized. This can lead to rapid progression through the rest of the logic tree and yield a confirmed identification.

When nonsimple differences are observed, the “art” of structure elucidation becomes more important. Simple differences can lead to very sensible, detailed procedures. The more difficult the work, the simpler the process map, because the activities have to become more creative and are often ill defined.

C. The Tools

The technique of mass spectrometry has been around for almost 100 years. Most practitioners target J. J. Thomson’s 1910–1912 reports⁵⁸ on his work with the parabola mass spectrograph as the origin. The field has evolved into a number of techniques—“tools”—that had significant utility initially, then either proved their worth over the long term as general purpose tools, settled into a particular niche application area, or faded entirely from view.

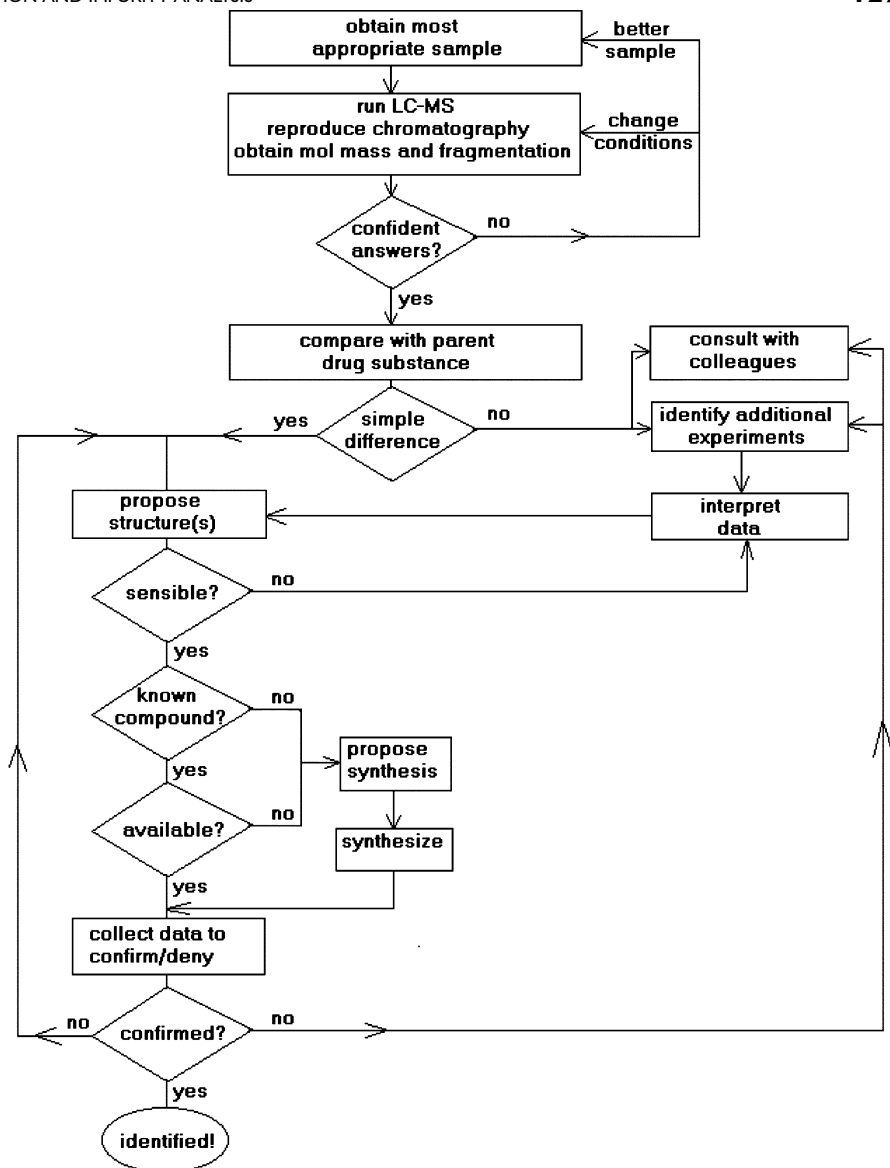

FIGURE 11 Mass spectrometry process flow chart for identification of impurities.

To perform mass spectrometry, one must make ions from neutral molecules. Ionization methods have advanced from the classic electron ionization (EI), through chemical ionization,⁵⁹ field desorption,⁶⁰ fast atom bombardment (FAB),^{61, 62} and thermospray⁶³ to the atmospheric pressure ionization (API) techniques currently favored. EI is classic, but it is restricted to thermally stable, volatilizable compounds. Field desorption was always a specialized niche technique applicable to some larger compounds. Fast atom bombardment enjoyed a meteoric rise in use when it was first reported in 1981 but it has all but disappeared now, being replaced by the API tech-

niques: atmospheric pressure chemical ionization (APCI)⁶⁴ and electrospray ionization (ESI).⁶⁵ Matrix-assisted laser desorption ionization⁶⁶ is used for characterizing larger proteins, approximately 100 kDa and larger.

The magnetic sector mass analyzer is the prototype instrument. A number of double-focusing sector geometries have been developed, but the sector instrument has largely become obsolete in recent years. Its expense, complexity, and difficulty of operation have caused its demise in favor of quadrupole instruments, time-of-flight (TOF) instruments, and ion traps. Improvements in the reflectron time-of-flight (rTOF) mass analyzer have even challenged the one remaining niche that the sector instruments and the equally technologically intense Fourier transform (FT) mass spectrometers occupy, namely, the high-resolution accurate mass measurement arena.

Applying two or more mass analyzers in series produces a tandem mass spectrometer (an MS–MS),⁶⁷ the best known of which is the triple quadrupole. A number of tandem sector geometries have been built, some of which are commercially available. Hybrid geometries combining a magnetic sector instrument with a quadrupole or an ion trap have also been built and characterized. The ion traps, triple quadrupoles, and, more recently, the tandem quadrupole–TOF instruments are more abundant and user-friendly. The quadrupole and the sector geometries provide the ability to perform tandem-in-space MS–MS experiments. The ion traps and FT–MS instruments permit performance of tandem-in-time MS–MS, allowing MS^{*n*} (mass spectrometry raised to the *n*th degree) experiments. Multiple MS–MS stages in space would require a mass analyzer for each MS–MS stage, rapidly making tandem-in-space experiments impractical for *n* greater than 2.

The evolution of the ionization techniques, discussed above, has progressed from the hard ionization (EI) technique, which produces extensive fragmentation, to the soft ionization (API) techniques, which produce in general only molecular ions.* In achieving the goal of being able to ionize larger, more polar, less thermally stable molecules and in optimizing for production of molecular ions, much of the structure-indicating fragmentation information has been lost. MS–MS experiments restore structural information content. They select the molecular ion produced by the soft ionization technique in the first mass analyzer of a tandem instrument and activate it by collision with a target gas. The product ion mass spectrum of fragments resulting from collision-induced decomposition (CID) of the parent ion in a later mass analyzer is recorded. The effect of inducing fragmentation by collisional activation can also be achieved through collision with solvent molecules in the API ion source. Various implementations of this procedure are called up-front CID, cone voltage fragmentation, and “poor man’s MS–MS.” Results obtained this way are comparable to true MS–MS product ion spectra. The strict interpretation of the results in terms of precursor–product ion relationships is lost, but this limitation does not negate the utility of the method when a true tandem instrument is not available.

*Hardness and softness of ionization refer to the energetics of forming an ion from a neutral molecule and the extent of spontaneous fragmentation resulting from the ionization process. Hard ionization techniques induce extensive fragmentation. Soft ionization techniques induce minimal or no fragmentation.

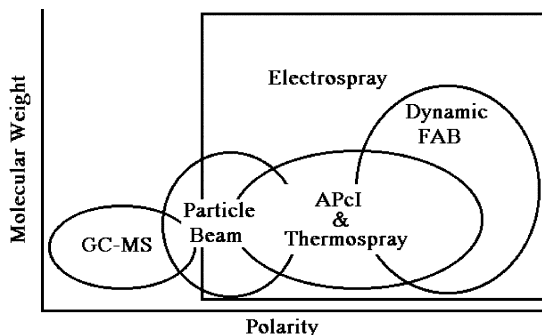

FIGURE 12 Applicability of various chromatography–mass spectrometry techniques to the molecular domain.

Inlet systems—the mechanisms through which one introduces samples into the mass spectrometer—have also evolved substantially. Heated expansion volumes and direct insertion probes have given way to interfaces that couple with chromatographic devices—gas, liquid, supercritical fluid, capillary electrophoresis, and thin layer—to the inlet of the mass spectrometer. This has given rise to a variety of combined chromatography–mass spectrometry techniques. Applicability of these various examples depends on the properties of the target compounds being analyzed. Figure 12 maps two common ways to classify organic compounds against each other to help visualize which techniques are appropriate for which types of molecules.

By examining this brief history of the development of instrumentation and methods, it should be clear what parameters define the instrument of choice for analysis of pharmaceutically important molecules. Such an instrument is one capable of performing LC–MS, typically using a reverse-phase HPLC separation and one of the API techniques. MS–MS capability is desirable—using an ion trap, a triple quadrupole, or other tandem mass analyzer instrument. Accurate mass measurement capability is also desirable. These attributes make up a prioritized list of capabilities for the “ideal” full-purpose instrument to be used in a pharmaceutical research environment. As one progresses through this list, the expense of the instrument increases, the sophistication of the instrument increases, and the intellectual and technological commitment required to do these experiments increases.

Now that we know what some of the tools are, the following will illustrate the utility of mass spectrometry in the arena of impurity/degradant identification using these tools. Recognize that we have left out a large variety of very valuable and interesting areas and aspects of mass spectrometry to focus on the analysis of pharmaceutically important compounds.

D. How to Use the Tools

I. Not The Universal Detector

The mass spectrometer has been touted as the universal chromatographic detector. This claim is not true! Like any other detector, the mass spectrometer exercises some degree of preference for materials being presented to it.

Consistent with this thesis, we have accumulated a growing list of molecules that are mass spectrometrically silent. Small molecules—in particular small aromatic molecules—exhibit a combination of volatility comparable with that of the mobile-phase solvents and a reduced ionizability under the ESP soft ionizing conditions to show minimal or no response in the mass spectrometer. Not every compound has a significant UV/visible (Vis) chromophore, but many UV-silent compounds respond very well in the mass spectrometer. In particular, a number of commonly used excipient molecules do not have useful chromophores. Even though the UV/Vis detector on the high-performance liquid chromatograph does not observe significant interferences from excipients, such as lactose or cellulose, the mass spectrometer suffers mightily from these UV-silent small molecules and polymers.

HPLC chromatographic methods should be developed off-line in the client project laboratories and not on an LC-MS system. It is, however, still essential to have a UV/Vis detector in-line with the mass spectrometer. The mass spectrometer detector has different molar responses to compounds than those of a UV/Vis detector. When the total ion current chromatogram does not resemble the UV/Vis chromatogram generated on another instrument, a simultaneously recorded UV/Vis chromatogram of the separation presented to the mass spectrometer is an invaluable piece of information. This chromatogram can help resolve disputes over whether the desired chromatography is being reproduced by the LC-MS instrument. Does a photodiode array (PDA) detector provide any significant advantage over a single wavelength UV/Vis detector? The primary advantage for a PDA detector is during method development when wavelength maxima are potentially unknown. Assuming the separation method is developed off-line and a detection wavelength has been chosen, we propose that there is little advantage to be gained over a single wavelength detector. The added complexity, expense, and computational sophistication, as well as manipulation and handling of the very large data files produced by the PDA detector diminish the return on the effort investment.

2. LC-MS Mobile Phases

With LC-MS experimentation as the goal, we assume the availability of a chromatographic method that adequately separates the components to be identified. The HPLC mobile phase must also be compatible with the mass spectrometric instrumentation. All components of the mobile phase should be volatile. Buffers need to be composed of a salt, both components of which are volatile compounds. Unfortunately, phosphate buffers and most ion-pairing agents are incompatible. Trifluoroacetic (to access very low pH), formic, and acetic acids are the preferred acids. Trifluoroacetic acid has been claimed in the literature to compromise sensitivity, but it is the only volatile organic acid that can provide very low pH. The ammonium counterion is preferred for pH adjustment of any of these three acids. Unfortunately, the necessity of using these acids eliminates the UV invisibility advantage that the phosphate buffers have, compromising results at low wavelengths—approaching 200 nm—for UV/Vis detection. Orthogonal spray devices in the LC-MS interface introduce a degree of immunity toward nonvolatile components in the sample and the

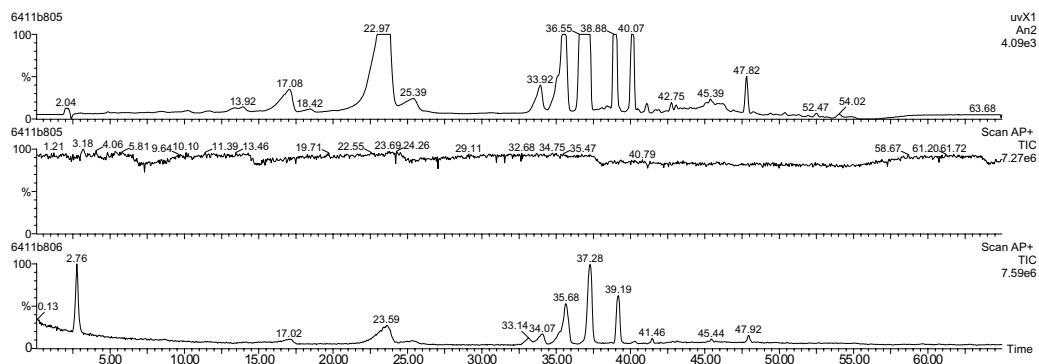

FIGURE 13 Comparative chromatograms with TEA acetate buffer (middle panel) and ammonium acetate (bottom panel). The top panel shows the chromatogram as indicated by UV/Vis detection.

mobile phase. At least two instrument manufacturers have produced commercially available orthogonal spray interfaces. Both show an increase in immunity to nonvolatile compounds. One manufacturer in particular has come close to eliminating the interferences caused by phosphate mobile phases.

Trifluoroacetic acid shows some reasonable ion-pairing behavior. We have also been able to use low concentrations of heptafluorobutyric acid as a reasonable substitute for the conventional octanesulfonate ion-pairing agents. Methanesulfonic acid is another ion-pairing agent under investigation.

Volatile buffer components alone are not sufficient to determine LC-MS compatibility. Triethylamine (TEA) is often included in a mobile phase to inhibit chromatographic peak tailing. Although it is a volatile component, it tends to quench the ionization process occurring in the API ion source of the mass spectrometer. Figure 13 illustrates this effect by comparing the total ion current chromatograms of a sample run in a TEA acetate-buffered mobile phase, and the same sample run in an identical composition mobile phase in which the TEA had been replaced by ammonia. The total ion current (TIC) chromatogram of the separation, run in an ammonium acetate mobile phase (Fig. 13, bottom panel), reproduces the chromatography as indicated by UV/Vis detection (Fig. 13, top panel). The TIC chromatogram of the same sample, using a TEA acetate mobile phase (Fig. 13, middle panel), showed no chromatographic features. Examining the mass spectral data at the retention time where the UV/Vis chromatogram indicates that a peak should elute, one can find mass spectral features representative of the major components. This example is also an excellent one to illustrate the necessity of including a UV/Vis detector in-line with the mass spectrometer. TEA is also very latent, in that TEA signals can be seen for days in non-TEA-containing systems, following a session with a TEA mobile phase.

3. APcI vs ESP

Which ionization method should one choose for a particular compound? Both APcI and ESP are considered to be soft ionization techniques, although ESP is the softer method. They are often implemented in the same ion source, with very simple conversion procedures to go from one to the other. For refer-

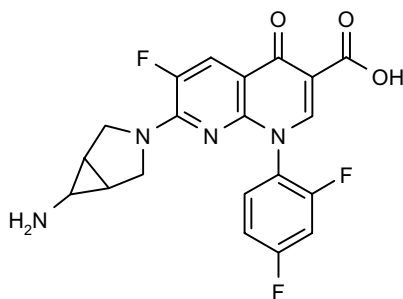

STRUCTURE 1 Trovafloxacin, $C_{20}H_{15}N_4O_3F_3$, r.m.m. 416.

ence with other mass spectrometric techniques, APcI is comparable in spectral quality and extent of spontaneous fragmentation to fast atom bombardment. APcI will also occasionally produce fragments that are not mass spectral fragments, but rather ones caused by the high operating temperatures typical of the APcI probe. ESP, being the softer method, is more prone to cluster formation. Both situations can produce misleading results.

The quinolone and naphthyridinone antibiotics, of which trovafloxacin (Structure 1) is a recently registered example, produce a fragmentation anomaly under APcI conditions.⁶⁸ With a carboxylic acid moiety, it might be reasonable to expect to see a decarboxylation fragmentation (loss of 44 Da) in the mass spectrum of this compound. The APcI mass spectrum (Fig. 14, top panel) shows a prominent $[M + H - 44]^+$ fragment at m/z 373. An ESP spectrum of trovafloxacin or an MS-MS product ion spectrum of the $[M + H]^+$ generated by either APcI or ESP, does not contain this fragment (Fig. 14, lower panel). This observation is consistent with a number of literature observations^{69,70} on compounds of this structural class, which indicate that this decarboxylation is a fragmentation thermally induced by the high APcI probe temperature—upwards of 500 °C. The more characteristic mass spectral fragmentation is dehydration from the carboxylate functionality.⁶⁸

An instance where the ESP behavior of a compound is misleading and the APcI behavior is more directly interpretable involves 4-aminohexahydroindacene (Structure 2). This compound shows extensive “clustering” in the ESP ion source,* producing species in the mass spectrum of much higher mass

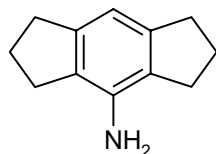

STRUCTURE 2 4-Aminohexahydroindacene, r.m.m. 173.

*The peaks at m/z 343 and m/z 514 are not simple noncovalent clusters! The masses correspond to multiples of the 173-Da molecular mass minus two protons per molecule. We do not fully understand this behavior.

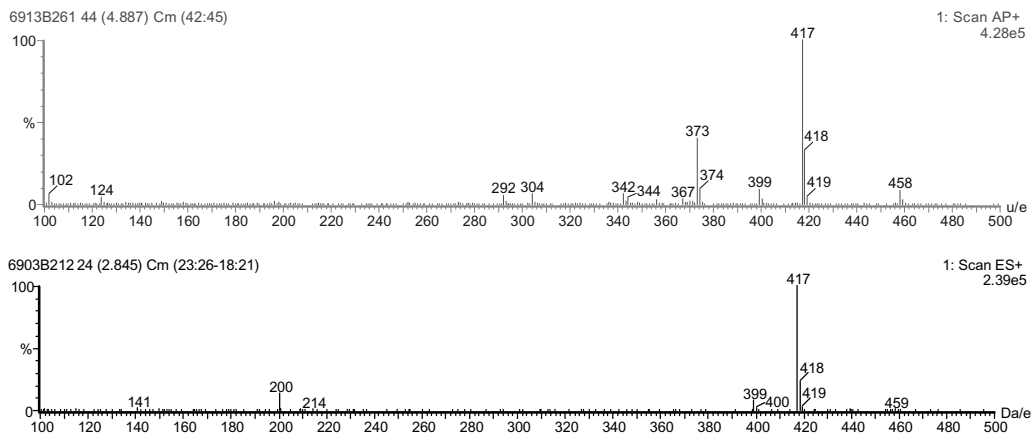

FIGURE 14 APci (top panel) and ESP (bottom panel) mass spectra of trovafloxacin.

than the expected m/z 174 $[M + H]^+$ (Fig. 15, upper panel). The spectrum is very misleading when one attempts to assign an $[M + H]^+$ to an unknown compound. APci (Fig. 15, lower panel) is required to obtain a clearer, less ambiguous indication of the true $[M + H]^+$ of this compound. Even so, one must remain cognizant of the fact that the experiment is being conducted using an acetonitrile-containing solvent and that the m/z 215 species is an acetonitrile adduct of the target molecule.

4. Monoisotopic vs Chemical (Average) Molecular Mass

The relative molecular mass* that is determined by the mass spectrometer is numerically different from the chemical (average) molecular mass used to calculate molar concentrations or reaction stoichiometries. For the elements

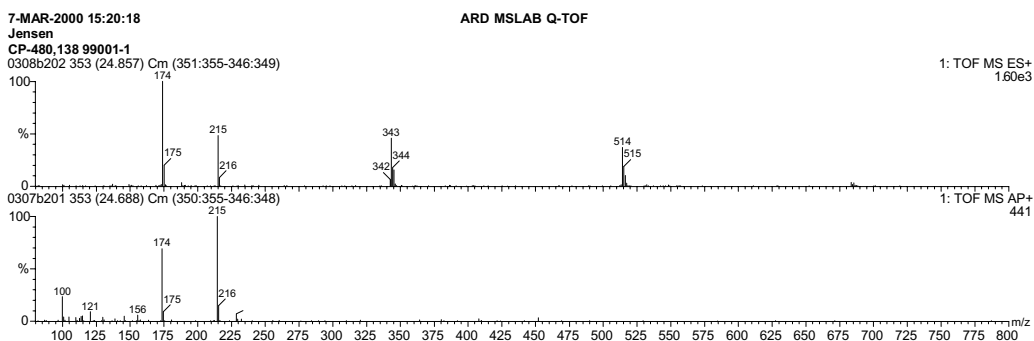

FIGURE 15 APci (top panel) and ESP (bottom panel) mass spectra of 4-aminohexahydroindacene.

*Molecular weight is an incorrect scientific term! The numerical value being referenced is a relative molecular mass. It is a mass, measuring a quantity of matter, not the influence on that matter by an external gravitational field. It is a relative mass, not an absolute mass measured in grams, because it is expressed in relation to the standard atomic mass of 12.000000 units (Daltons), assigned to the ^{12}C isotope of carbon. It is a relative molecular mass because it is a sum of all the relative atomic masses of the elements contained within the molecule.

commonly found in organic molecules, the numbers are very close and in many contexts are interchangeable. However, when one discusses an accurate mass measurement made by a mass spectrometer for a molecule that contains significant polyisotopic elements such as chlorine or bromine, or when the mass of the molecule gets large, the numbers become significantly different. One must exercise care and be explicit about which kind of molecular mass number one is discussing.

Further complicating the situation, mass spectroscopists often discuss nominal (integral) masses and exact (or accurate) masses. The term “nominal mass” derives from the fact that the relative atomic masses of all the isotopes are very close to integral values—e.g., carbon is 12, hydrogen is 1, and oxygen is 16. The nominal molecular mass of a molecule is calculated using these nominal atomic mass values. Nominal masses are the values discussed in most instances. Accurate (exact) masses derive from increasing the precision with which the relative masses of atoms and molecules is measured. This increased precision reveals that the masses of the isotopes are not exactly integral. They all—with the exception of ^{12}C , which is arbitrarily assigned to be 12.0000—exhibit a mass defect ranging from a few thousandths to a few hundredths of a dalton above or below the nominal integral mass. Mass-deficient isotopes (oxygen, sulfur, phosphorus, and the halogens) have an exact mass less than the integer. Mass-sufficient isotopes (^{13}C , hydrogen, and nitrogen) have an exact mass greater than the integer. A list of the accurate masses of the isotopes and their natural abundances can be found in most mass spectrometry textbooks and has been published in several places throughout the general chemical literature.⁷²

Even mass spectroscopists use the terms “exact mass” and “accurate mass” interchangeably when they probably should not. An exact molecular mass is the mass calculated from the accepted exact atomic masses of the isotopes for a specified empirical formula. It is the value that one would expect to observe if one could measure a molecular mass exactly. An accurate mass is a value measured carefully, with high precision, on an instrument capable of making such precise measurements, typically expressed to at least four decimal places—the nearest 0.1 mDa. An accurate mass measurement is compared to the exact masses of empirical formulae being considered. Sufficiently accurate measurements can be used to “assign” empirical formulae to peaks in a mass spectrum. Knowing that these two terms are commonly used interchangeably, but that there may be subtle differences in the way practitioners use them, is sufficient for our discussions here. We will comment more on the utility of accurate mass measurements later.

5. Cluster Ions and Adduct Ions

The quest for an ionization method that guarantees a molecular ion for all compounds has driven the development of softer and softer methods. As the goal is approached, a wealth of new exceptions to the rule have been observed. Cluster ions and adduct ions form in the matrix (for FAB ionization) or in the spray of the API methods, depending on the nature of the compound, the matrix, the solvent, or extraneous salts present in the sample or in the instru-

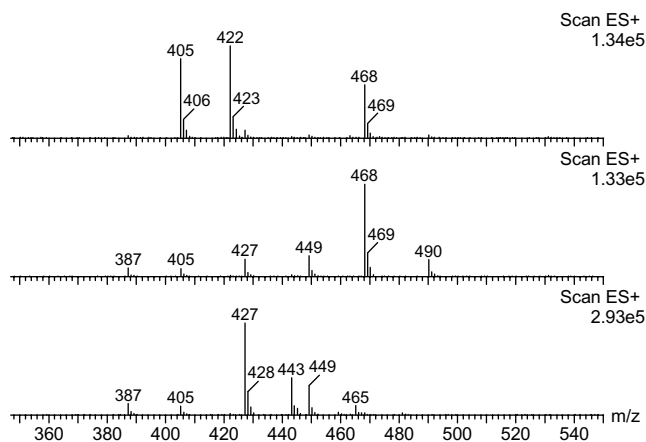

FIGURE 16 Formation of different adduct ions under different solvent conditions. Samples of a 404-Da molecule dissolved in and introduced in (top panel) 1:1 acetonitrile/20 mM aqueous ammonium acetate, (middle panel) 1:1 acetonitrile/water, and (bottom panel) 1:1 methanol/water.

ment. Although these species complicate interpretation of results and require appropriate care in interpretation, their presence can be useful.

The ubiquitous nature of the sodium cation often leads to Na^+ cationization and the presence of $[\text{M} + \text{Na}]^+$ in the mass spectrum in addition to, or in place of, $[\text{M} + \text{H}]^+$. Efforts to either remove or add Na^+ from the sample result in changes in the relative abundances of the $[\text{M} + \text{H}]^+$ and $[\text{M} + \text{Na}]^+$. Addition will often cause replacement of other labile protons with additional sodium atoms. Addition of lithium or potassium can replace the Na^+ , with the appropriate mass changes, to confirm the identity of the Na^+ adducts. Ammonium cationization will often occur from LC-MS mobile phases containing an ammonium buffer salt. Acetonitrile solvent adducts will also often form.

An example of a molecule that exhibits extreme dependence on solvent conditions is shown in the partial spectra of Figure 16. The molecule has a 404-Da relative molecular mass. The material is produced as the sodium salt. Samples of the same material have been dissolved in and introduced into the electrospray ion source using three different solvents. The m/z 405 species is the $[\text{M} + \text{H}]^+$. The m/z 422 species is an $[\text{M} + \text{NH}_4]^+$. The m/z 427 species is an $[\text{M} + \text{Na}]$. The m/z 468 species corresponds to an $[\text{M} + \text{Na} + \text{acetonitrile}]^+$. Examining any of these three spectra in isolation, one cannot easily tell which is the real $[\text{M} + \text{H}]^+$. However, once one knows that a particular class of molecule—such as this one—behaves in this manner, one can use the presence of the cluster ions as additional supporting evidence for assigning the molecular mass of the compound. This phenomenon adds uncertainty about assuming the behavior of unknown compounds. If one can safely assume that an unknown impurity or degradant has a structure sufficiently similar to that of the parent molecule to behave in the same manner, then the adduct formation helps to confirm molecular mass assignments. Looking for 17 Da (NH_4^+), 22 Da (Na^+), 38 Da (K^+), or 41 Da (acetonitrile) mass differences, or various combinations of these numbers, will provide some level of comfort in assuming adduction behavior.

6. Isotope Patterns

The consideration of molecular mass is further complicated by the existence of a number of significantly polyisotopic elements. Isotope patterns in a mass spectrum are the manifestation of the relative abundances of the naturally occurring isotopes. A number of elements are polyisotopic, some of the more dramatic examples being bromine and chlorine. Tin is the most dramatic, having a total of 10 naturally occurring stable isotopes of significant abundance spread over a 12-Da range, 7 of which have 5% relative abundance or greater. Given this complication, determination of the “correct” molecular mass is controversial. Polyisotopic elements immediately divide practitioners into two camps. One camp says the molecular mass is that calculated using the lowest mass isotope of each element in the molecule. The other camp says the molecular mass is that calculated using the mass of the most abundant isotope of each element. In most instances, these two rules generate the same number. The most abundant isotope of carbon, hydrogen, oxygen, nitrogen, sulfur, phosphorus, and all of the halogens is indeed the lowest mass isotope. Boron-containing molecules or organometallic compounds containing a polyisotopic transition metal or heavy metal may more appropriately require application of the second rule.^{71, 73} Applying either of these rules, however, becomes even more complicated when a molecule contains, for example, three or more chlorine atoms, two or more bromine atoms, or more than one metal atom.

a. In Normal Mass Spectra

In conventional mass spectra the isotope patterns deriving from the presence of polyisotopic elements are striking and quite noticeable. An excellent example is the ESP spectrum shown in Figure 17 for a compound with a $C_{14}H_{12}NOFCl_2$ empirical formula. The m/z 300 $[M + H]^+$ and the m/z 269 neutral loss fragment (resulting from neutral loss of methylamine) clearly show Cl_2 isotope patterns which match well with simulations.* The m/z 234

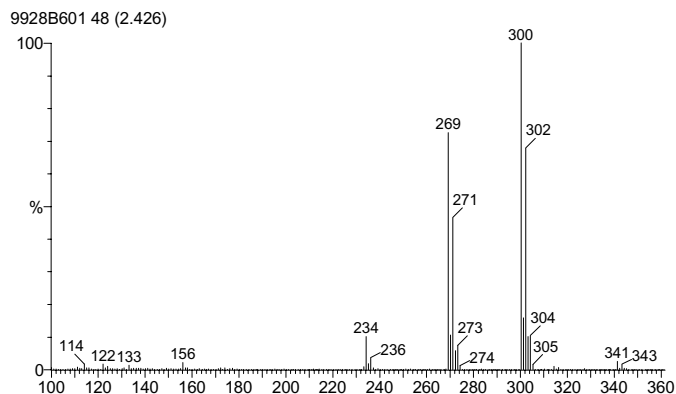

FIGURE 17 ESP mass spectrum of a molecule containing two chlorine atoms.

*The well-done mass spectrometry data systems all have isotope pattern modeling programs built in. A number of other stand-alone simulation programs are also available.

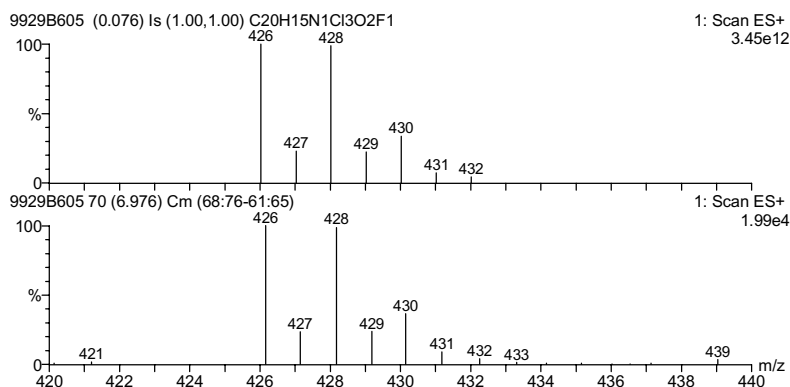

FIGURE 18 Comparison of the isotope pattern for the observed $[M+H]^+$ (bottom panel) with the predicted model (top panel) for $C_{20}H_{15}NO_2FCl_3$.

fragment results from further loss of one of the chlorine atoms, illustrating a clear Cl_1 isotope pattern, and the utility of the isotope patterns in assigning structure.

The close match of simulation (Fig. 18, upper panel) and observation (Fig. 18, lower panel) of the $[M+H]^+$ of another chlorine-containing compound, along with some chemical considerations of the history of the sample, permitted assigning the structure of the unknown compound based solely upon the isotope pattern.

b. In MS–MS Product Ion Spectra

The interpretation of isotope patterns changes when applied to MS–MS product ion spectra. Consider the product ion spectrum in the top panel of Figure 19 of the same m/z 300 $[M+H]^+$ discussed above. The experiment was performed on a triple quadrupole instrument by selecting the m/z 300 species with the first analyzer under unit resolution conditions. The m/z 300 species was collisionally activated in the second quadrupole collision cell. The product ion spectrum resulting from collision-induced decomposition was recorded in the third quadrupole mass analyzer. Recall that the empirical formula of this molecular ion is $C_{14}H_{13}NOFCl_2$. Why have the very prominent isotope patterns disappeared? Because one has selected the m/z 300 species as the parent, there is no longer any consideration of polyisotopy. This parent is a monoisotopic parent—namely $C_{14}H_{13}NOF^{35}Cl_2$. Methylamine neutral loss produces a single species— m/z 269. Further fragmentation with sequential loss of chlorine atoms produces single species— m/z 234 and m/z 199—because the only chlorine isotope that can be lost from this selected m/z 300 parent is a ^{35}Cl atom.

Why does an isotope pattern reappear in the product ion spectrum of the m/z 302 parent (Fig. 19, middle panel)? The elemental composition of the parent is now $C_{14}H_{13}NOF^{35}Cl_1^{37}Cl_1$. The m/z 271 species shows no polyisotopic signature because its formation results from loss of CH_3NH_2 from the parent to give $C_{13}H_8OF^{35}Cl_1^{37}Cl_1$ —only one possible elemental composition. Loss of the first chlorine atom, however, now permits production of two possible elemental compositions— $C_{13}H_8OF^{35}Cl_1$ and $C_{13}H_8OF^{37}Cl_1$ at m/z

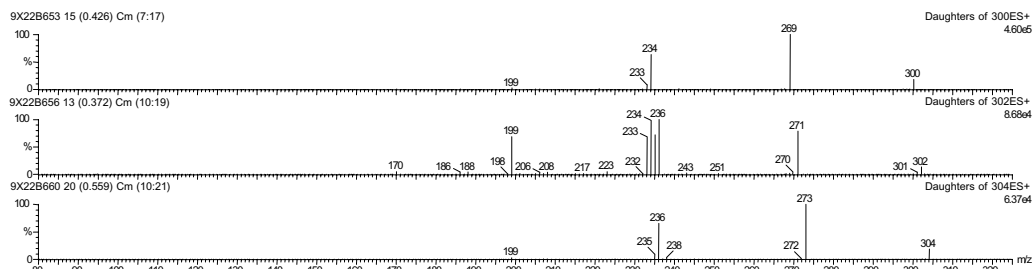

FIGURE 19 MS-MS product ion spectra of the m/z 300 (top panel), m/z 302 (middle panel), and m/z 304 (bottom panel) $[M + H]^+$.

234 and m/z 236. They are of equal abundance because of the equal probability of loss of either a ^{35}Cl or a ^{37}Cl atom in the fragmentation process. The fact that the natural abundances of the chlorine isotopes is approximately 3 to 1 is irrelevant here. Selecting the m/z 302 species as the parent sets the isotope ratio of ^{35}Cl to ^{37}Cl in this experiment to be 1 to 1. The isotope pattern disappears on loss of the second chlorine to give the m/z 199 species because the source of polyisotopy is now completely gone.

All evidence of isotope patterns in the product ion spectrum of the m/z 304 parent (Fig. 19, bottom panel) disappears because the selected parent is monoisotopic— $\text{C}_{14}\text{H}_{13}\text{NOF}^{37}\text{Cl}_2$. Justification for the absence of isotope patterns is identical to that of interpretation of the m/z 300 product ion spectrum. The detailed explanation of this excellent example serves to illustrate the care one needs to exercise in interpreting isotope patterns (or the lack thereof) in MS-MS spectra. At the same time, it demonstrates the structure-indicating power of careful interpretation.

With the recent development of the combined quadrupole time-of-flight tandem instrument geometry, MS-MS product ion spectra are starting to appear in the literature with isotope patterns reflecting the natural abundance of the involved elements. Considering the discussion above, how does this occur? Note that our selection of parent ions for collision-induced decomposition in the experiments described above was done under unit resolution conditions. With a tandem instrument composed of a quadrupole and a time-of-flight mass analyzer, the resolution of the first mass analyzer can be set to substantially less than unit resolution, such that the entire isotope pattern can be selected as the “parent.” This approach preserves the isotope pattern information while providing MS-MS product ion information. This new consideration must be added when one interprets isotope patterns in MS-MS spectra—namely to identify the instrument on which the experiment is being done and how it is set up.

*Some individuals have taken offense at the usage of the originally coined term “daughter ion” in describing the ion genetic relationships resulting from a collision-induced decomposition experiment. The more palatable term “product ion” has come into use as an alternative. We have attempted to refer to product ions in our discussions. Notwithstanding, the term “granddaughter” conveys a certain meaning about the skipping-of-generations relationship between a product formed by two or more sequential chemical reactions from its original parent. No companion term comparable to “product ion” has yet arisen that conveys this meaning. For this reason, we still use the term “granddaughter ion” here in this limited context.

7. Unimolecular Decompositions vs Granddaughter* Ions

The theoretical concept behind MS–MS involves unimolecular decomposition to establish ion genetic relationships between fragments and their parent structures. The difficulty in interpreting a conventional mass spectrum consisting of more than one component is determining which fragment belongs to which parent. Another problem occurs when a fragment gives rise to another fragment via a sequence of fragmentations. This dilemma is tremendously improved by having a chromatographic separation on the front of the experiment, giving some assurance that one is looking at the mass spectrum of a single compound and that all fragments are ultimately derived from one parent. This is not the case when one still has co-eluting components. MS–MS experiments seek to eliminate this uncertainty. These experiments assume an “infinitely thin” collision zone and single collisions of the parent with a collision gas, depositing only sufficient energy to induce one unimolecular decomposition reaction. These assumptions are not sustained when a physically large quadrupole collision cell is used. Multiple collisions at high energy are possible. Product ions can also undergo collisional activation before they leave the collision cell. Granddaughter and great-granddaughter ions can be formed and detected in the MS–MS spectrum. How does one tell a unimolecular decomposition from a multistep decomposition? Fragmentations requiring the breaking of multiple bonds at multiple sites in the molecule can indicate multistep decomposition.

Examination of the collision energy dependence of the product ion spectrum is a functional test. To illustrate, the product ion spectra of the m/z 300 $[M + H]^+$ of a molecule of empirical formula $C_{14}H_{12}NOFCl_2$ at three different collision energies are shown in Figure 20. This is the same molecule on which the isotope pattern discussion in Section IV.D.6 is based. The top panel, at low collision energy, shows significant survival of the $[M + H]^+$ and loss of a 31-Da species, corresponding to neutral loss of methylamine—a sensible fragmentation, as the original molecule contains an aliphatic *N*-methylamine side chain. Only just appearing is an m/z 234 fragment, corresponding to further

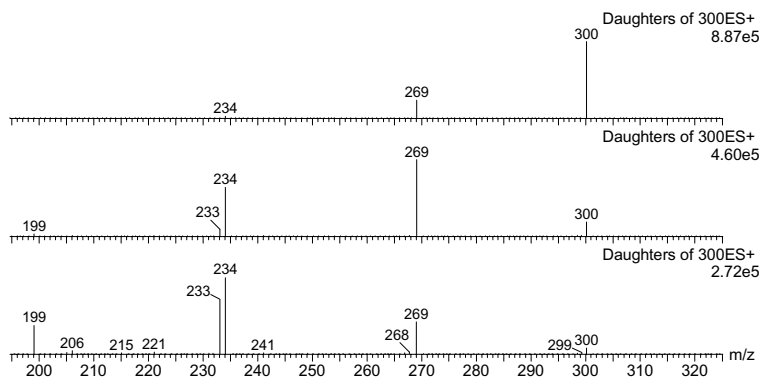

FIGURE 20 MS–MS product ion spectra of the m/z 300 $[M + H]^+$ at 10 V (top panel), 20 V (middle panel), and 30 V (bottom panel) interface cone voltages.

loss of one of the chlorine atoms. That the methylamine and chlorine moieties are distant from each other in the original structure implies that these are two separate events and that the m/z 269 species is losing the chlorine. If chlorine were to be lost directly from the parent ion, an m/z 265 species would be present, and it is not.

Increasing the collision energy, as illustrated in the two lower panels of Figure 20, further destroys the $[M + H]^+$ and induces more extensive fragmentation of the m/z 269 species. It increases the relative abundance of the first chlorine atom loss and induces a further loss of the second chlorine atom, producing the m/z 199 species. The collision energy dependence of the abundance and appearance of product ions indicates that these species are the result of a sequence of fragmentations, and helps one correlate back to the original structure of the molecule.

8. Multiply Charged Ions

ESP-generated multiply charged ions are most frequently discussed in the examination of peptides and intact proteins. The general observation is that peptides need to be on the order of 1500–2000 Da or larger to form abundant multiply charged ions (i.e., doubly charged ions). Although doubly charged molecular ions have been reported in the electron ionization mass spectra of polycyclic aromatic hydrocarbons,⁷⁴ mention of multiply charged ions in the context of classic mass spectra of small molecules is rare. In our work on impurities and degradants of small pharmaceutical molecules, however, we are starting to see an increasing frequency of doubly charged molecular ions in the electrospray mass spectra—molecules with relative molecular masses as low as 500–600 Da. The factors that determine whether or not and to what extent a molecule will form doubly charged molecular ions are still under investigation. How does one tell if one has a doubly charged species?

ESP mass spectra of compounds often contain van der Waals clusters of the molecule. Numerologically, these species appear at two times the relative molecular mass of the molecule plus one. Consider the example spectrum shown in Figure 21. The m/z 403 species could be assigned to be the $[M + H]^+$ of the compound in question, indicating a relative molecular mass of 402 Da. It was indeed the most abundant peak in the spectrum. A proton-bound dimer would correspond to a $[2M + H]^+$ peak at m/z 805, consistent with the expanded spectral portion shown in Figure 22. The relative abundance of the m/z 805 species is approximately 10% that of the m/z 403 species, consistent with typical relative abundance observations of $[M + H]^+$ and $[2M + H]^+$. The convention would be to assign the $[M + H]^+$ to be the largest peak in the spectrum. The fact that a 402-Da molecular mass exhibited an illogical mass difference between this and the drug substance molecule under investigation prompted reexamination of the m/z 403 region and the putative assignment of this species as the $[M + H]^+$.

Close examination reveals that the peaks comprising the isotope pattern of the m/z 403 species in Figure 21 appear at 0.5-Da intervals. The nature of the instrument on which this spectrum was obtained and the confidence

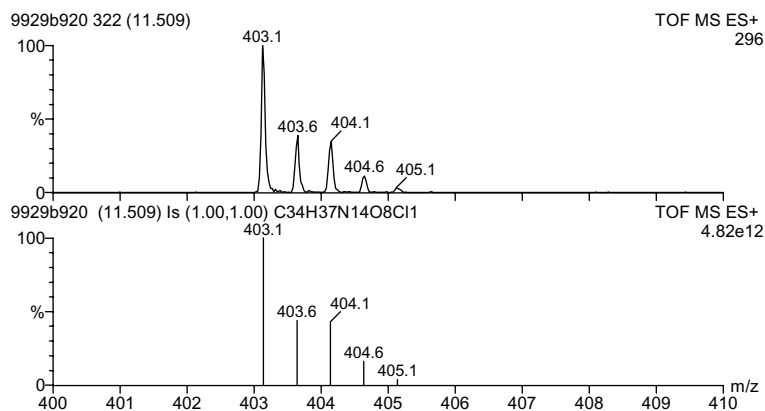

FIGURE 21 Comparison of the isotope pattern of the doubly charged molecular ion region (top panel) and the isotope pattern modeled (bottom panel) from the $C_{34}H_{37}N_{14}O_8Cl_1$ elemental composition of the m/z 403 doubly charged molecular ion.

in mass assignments indicate that these mass assignments were indeed correct and that this spectrum represents a doubly charged ion. Recall that the mass spectrometer does not measure mass but mass to charge ratio. Typically, for small molecules, ions carry only a single electrostatic charge, and the m/z value reduces to the mass. The interval between isotope peaks in a pattern such as this should be 1 Da. The 0.5-Da spacing indicates that the m/z 403 species is really a $[M+2H]^{2+}$. The m/z 805 species is the true $[M+H]^+$, and the molecular mass is really 804 Da. This reassigned molecular mass and a consideration of the synthetic chemistry of the drug substance being studied were sufficient to propose a reasonable identity of the impurity.

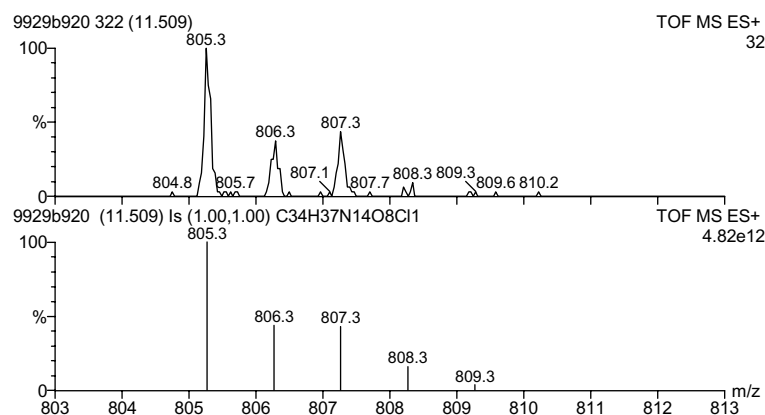

FIGURE 22 Comparison of the isotope pattern of the singly charged molecular ion region (top panel) and the isotope pattern modeled (bottom panel) from the $C_{34}H_{37}N_{14}O_8Cl_1$ elemental composition of the m/z 805 singly charged molecular ion.

9. Polymer Patterns vs Multiply Charged Ion Series

Another striking feature that can be seen in the overall appearance of a mass spectrum is a repeating series of peaks at a regular interval—a “polymer pattern.” It is almost as striking as an isotope pattern. Such a pattern is illustrated by the spectrum shown in Figure 23, an ESP mass spectrum of a mixture of poly(ethylene glycol) (PEG) molecules (Structure 3). Various PEG mixtures and similar polymers are frequently used as mass calibrants and accurate mass reference standards. The spectrum shown is of a mixture of two commercially available PEG preparations of 200 and 400 Da average molecular masses.* The constant interval between the repeating peaks is 44 Da, the mass of the PEG repeating unit. The m/z 239 peak is the $[M+H]^+$ of a PEG molecule with five repeating units—PEG₅. The m/z 261 peak is the $[M+Na]^+$ of PEG₅. The m/z 476 species is the $[M+NH_4]^+$ of PEG₁₀. The sample solution was prepared by dissolving the PEG in aqueous ammonium acetate, providing a source of ammonium cation. This spectrum illustrates the interesting phenomenon of Na^+ cationization and of preferential NH_4^+ cationization by the larger PEG polymers. Recognizing these features, the complicated spectrum can be easily interpreted. One can visually pick out the components of each series and estimate the average molecular masses of the original PEG starting materials. An obvious PEG polymer pattern was key in identifying a drug-excipient interaction in a formulation containing PEG. The drug substance, a carboxylic acid, formed a series of esters with the terminal alcohol group of the PEG molecules. The mass spectrum clearly showed this pattern of peaks, separated by 44 Da, with the masses offset from those of PEG by the mass of the drug substance.

With the increasing application of ESP to the examination of intact proteins (illustrated by the example in Figure 24), one observes a pattern outwardly resembling that of a polymer. This feature is not in fact a polymer pattern but a multiply charged ion envelope of a single chemical species. The spectrum in Figure 23 represents the $[M+H]^+$ of a collection of molecules of different sizes. The protein used here is bovine serum albumin, a single molecule with a chemical molecular mass calculated from this spectrum of 66,424 Da. The definitive way to differentiate a polymer pattern from a multiply charged ion series of a protein is evaluation of the spacing of the peaks. A polymer pattern will show peaks spaced at a constant mass interval across the entire series. A multiply charged ion series will show steadily increasing mass spacing as one traverses the pattern from low mass to high mass.

While this chapter is primarily concerned with the characterization of small molecules, it is useful to point out some of the differences in interpretation and thought process needed to interpret mass spectra of proteins. The shift

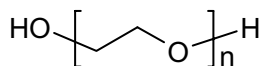

STRUCTURE 3 Poly(ethylene glycol), $(C_2H_4O)_nH_2O$, r.m.m. $44n + 18$.

*Note here that the term “average molecular mass” applied to a polymer implies yet another nuance in the usage of the term “molecular mass.”

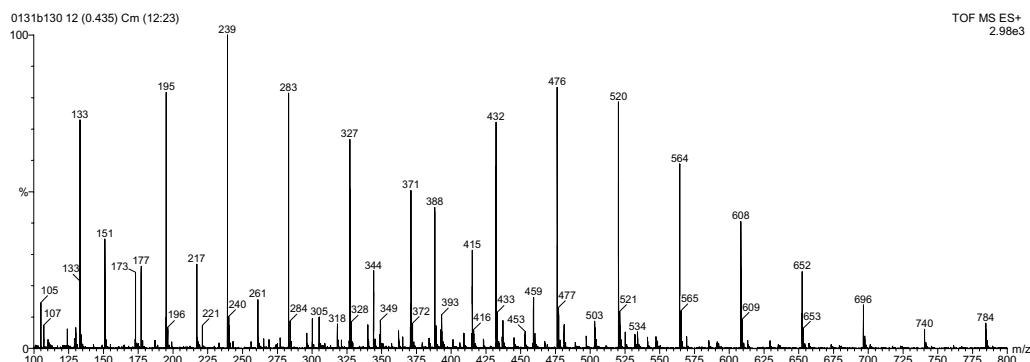

FIGURE 23 Positive ion ESP mass spectrum of a poly(ethylene glycol) mixture.

from monoisotopic molecular masses in small molecules to chemical molecular masses in peptides and proteins is necessary when the chemical entities exceed 1500 to 2000 Da. Mass calibration procedures and philosophies of instrument operation change. The concept and application of chemical molecular mass accuracy changes from 0.1 to 0.2 Da accuracy for nominal monoisotopic measurements to 0.01–0.02% for proteins (acceptable 0.01% accuracy for the bovine serum albumin example used here is ± 7 Da). In short, the mass spectrometry of proteins and other intact biopolymers deserves an entire monograph of its own.

10. Accurate Mass Measurements

The mass spectrometry community is experiencing a resurgence of activity concerning accurate mass measurements. Improvements in performance of the rTOF mass analyzers have stimulated this interest. John Beynon's⁷⁵ demonstration that a sufficiently accurate measurement could be used to indicate an empirical formula is the basis for this interest. Confidently establishing an empirical formula for an unknown molecule is a significant step toward characterizing the molecule's structure.

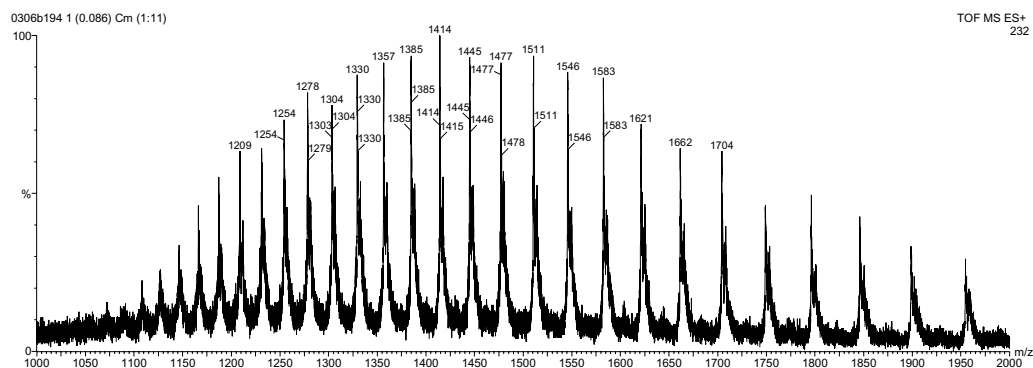

FIGURE 24 Positive ion ESP mass spectrum of bovine serum albumin. The average molecular mass observed here for this protein is 66,424 Da. There are two additional higher mass proteins in this sample.

The challenge is to have an instrument capable of making accurate mass measurements, to have one that can be operated in the required manner on demand, and to have confidence that the measurements obtained accurately represent the species being studied. Historically, this area has been the domain of sector instruments and Fourier transform instruments. Improvements in rTOF instruments are challenging this dominance. If the ability to obtain accurate mass measurements is a requirement, one must accept this instrumental challenge.

One must also accept the challenge and responsibility of using accurate mass measurements correctly. Kondrat⁷⁶ illustrates some of the prevalent misconceptions about the utility and appropriateness of accurate measurements. Busch⁷⁷ illustrates the use and limitations of accurate mass measurements. Biemann's⁷⁸ discussion drives the point home in much more detail. He lists three typical uses for accurate mass measurements: elucidation of fragmentation pathways, confirmation of structure of synthetic products, and elucidation of completely unknown structures. The demands for necessary precision, accuracy, and care in measurements increase in the order given. Instructions to authors on use of accurate mass measurements from the *Journal of Organic Chemistry*⁷⁹ and the *Journal of the American Society for Mass Spectrometry*⁸⁰ now reflect this concern for proper use of such measurements. One mass spectrometry laboratory in a pharmaceutical company^{81, 82} routinely did accurate mass measurements on all samples in support of the synthetic organic laboratories. Our experience suggests that accurate mass measurements, although very valuable when used properly, are secondary experiments to be done when needed.

11. Mass Spectral Fragmentation Compendia

The concept of the organic functional group—that a particular organic functional group will behave in essentially the same way, regardless of other functional groups attached to it—holds true in the mass spectrometer, too. For this reason, compilations of mass spectral fragmentation data for organic compounds are useful sources for help when one interprets mass spectra. Two of the better-known libraries are the NIST/EPA/MSDC mass spectral database, maintained by the United States National Institute of Standards and Technology, and the Wiley–McLafferty database, published by John Wiley & Sons, Inc. These two differ in that the NIST collection contains only one spectrum representing a given compound. The Wiley–McLafferty collection contains a larger number of spectra, but includes multiple spectra for some compounds, intending to capture information on variability of spectra from observation to observation and instrument to instrument. There are a number of smaller and more specialized collections. The Thermodynamics Research Center at Texas A&M University still collects compounds and compiles data, which eventually are incorporated into the NIST and Wiley–McLafferty libraries. Several compendiums have been published.^{83–85} They are dated, but nevertheless effectively capture the collective fragmentation information before their publication. Unfortunately, all of these information sources discuss electron ionization spectra. EI fragmentation rules can be of limited assistance

in interpreting MS–MS product ion spectra. One small collection of chemical ionization information has been published.⁵⁹

Compilation of spectral catalogs for the soft ionization techniques—chemical ionization, FAB, and API—has not occurred, for at least two reasons. First, the exact nature of a soft ionization spectrum depends upon instrument and sampling conditions. Second, for many compounds analyzed by the soft ionization techniques, the spectrum consists principally of a molecular ion. A compilation of soft ionization spectra, in its ideal form, would be a compilation of molecular masses. Movements promoting the compilation of MS–MS product ion spectra have surfaced several times. As we have seen from some of the discussions above, these too depend upon exact operating conditions. Lack of an acceptable standard set of conditions has hampered everyone's efforts to make such a project happen.

12. Interpreting Spectra for Structure

All of the aspects discussed above for extracting structural information from mass spectral data come into play in some way when one is presented with a structure elucidation problem; however, this is not the complete set of tools and techniques. Finding that one obscure but revealing literature reference, flashes of insight in the middle of the night, snippets from one's collective personal and professional experiences, and interactions with others practicing the art are all ill-definable but nevertheless important contributions to this process. One can apply a degree of systematic practice, but structure elucidation from spectral (and other) data is still largely an empirical method and still requires significant amounts of time spent simply staring at the data.

V. ROLE OF NMR

A. Introduction

The ability of NMR to provide information regarding the specific bonding structure and stereochemistry within a molecule has created broad applicability across physics, chemistry, biology, and medicine.^{86–90} NMR provides a powerful analytical tool for structural elucidations. Unfortunately, the sensitivity of NMR traditionally has been limited compared with that of other analytical techniques. For example, conventional sample requirements for NMR are on the order of 25 mg compared with less than 1 mg for mass spectroscopy. For this reason, NMR spectroscopy historically has not been the first approach for an analytical chemist when identifying an unknown compound.

Recent technological advancements in the field of magnetic resonance have allowed significant strides in improving sensitivity levels.^{91–93} This becomes particularly important in the structural characterization of drug impurities and degradants, which often are available only in extremely limited quantities. The nondestructive, noninvasive nature of NMR spectroscopy makes it a valuable tool for the characterization of low-level impurities and degradants. In addition, NMR can be considered close to a “universal detector” for hydrogen and carbon, as well as for other magnetically active nuclei. This is both good

and bad, because all signals are detected—those arising from the compound of interest as well as all those from other components in the sample, such as solvent and starting materials. Quantitation is accurate over a dynamic range of nominally 4 orders of magnitude, although it is not as precise as that of other analytical tools particularly at low levels. This poses a challenge for studying mixtures containing low-level components. The preference is therefore, if possible, to isolate a given impurity before study by NMR rather than to analyze a mixture.

The following discussion focuses exclusively on what are termed “small molecules” in the industry, namely compounds with a molecular mass on the order of one 1000 Da or less. The study of proteins, polymers, and other such “macromolecules” by NMR warrants an entirely different approach that is beyond the scope of this book. Similarly, we will restrict our discussion to liquid-state NMR spectroscopy, since the quantity of sample available for the characterization of a degradant or impurity is typically far below reasonable amounts needed for most solid-state NMR techniques. The overall characterization strategy we will use for NMR is shown in Figure 25.

B. Information Gathering

Arguably the single most important piece of non-NMR data used by the NMR spectroscopist is the total molecular mass. Although not required for structural elucidations, this information greatly facilitates the characterization process by reducing the number of possible structures. As discussed in Section IV.A, certain mass changes are indicative of specific structural fragments. Furthermore, in many cases fragmentation patterns can identify which portion of the molecule differs from the parent species, thus pinpointing the degradation site. However, one should keep in mind the capabilities and limitations of each technique when identifying possible structures with or without atmospheric pressure. The harshness of the ionization technique will determine whether the sample was partially destroyed, for example, in the case of peroxides. Also, if LC–MS was performed, one should consider the possibility of co-elution of multiple components, especially stereoisomers. All of this information must be balanced with the NMR data when considering plausible structures.

Another fruitful source for identifying possible structures is the sample's origin. Was the sample extracted from a mother liquor, isolated from a bulk lot, or synthesized from precursors? It is useful to know the synthetic route or isolation pathway followed to prepare the sample, at least the last two to three steps. Not only will this provide clues to the possible structure based on predicted chemical reactions, it will also reveal any possible contaminants in the NMR sample. This will become important if the sample purity is low. Some examples of common contaminant sources are residual excipients, other formulation components such as intravenous bags and reaction vessels (contaminants from previous use), plasticizers, and stopcock grease.

Unfortunately often little is known about the inherent properties of a degradant or impurity before it has been fully characterized. There are several properties, if the information is available, that are useful to know for proper handling of the NMR sample. First, it is essential to have an approximate idea

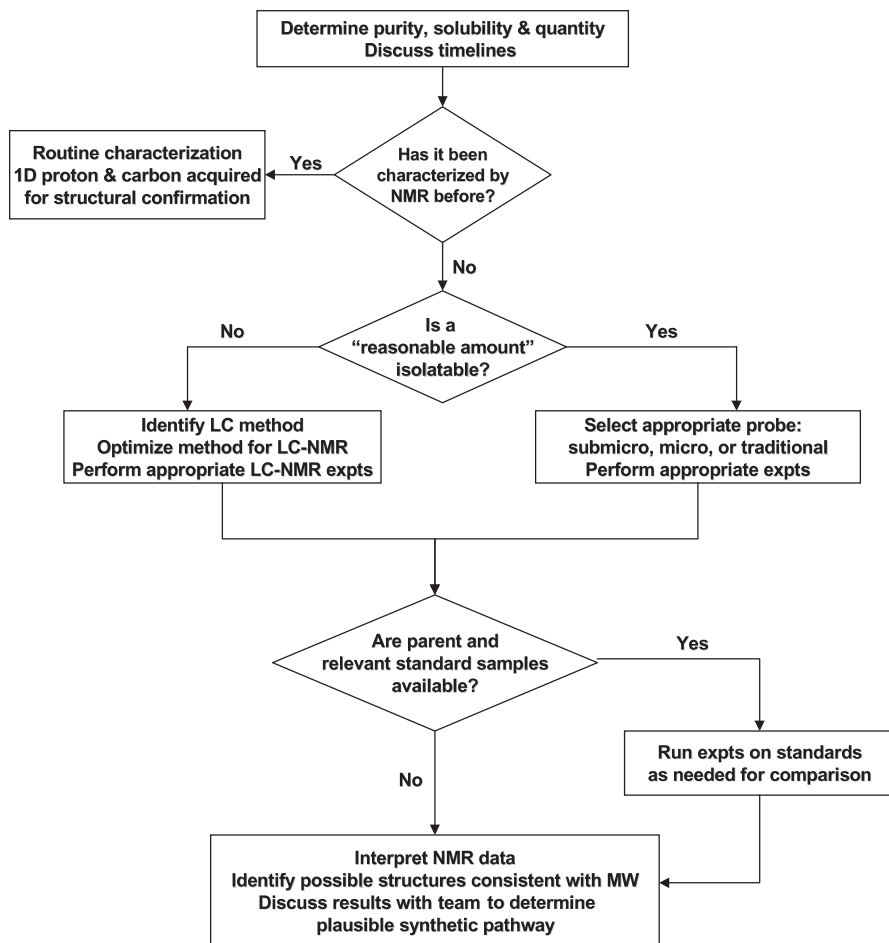

FIGURE 25 Flow chart for structural characterization of impurities and degradants by NMR. 1D, one-dimensional; MW, molecular weight.

about the quantity and purity of the sample, because this will determine which NMR hardware is most appropriate. We will discuss specific quantity requirements in Section V.C on NMR instrumentation, but for now, let it suffice to say that approximately 1 mg of targeted compound is required. Of course, this value is directly related to the sample purity, because 1 mg of sample with a purity level of 50% would contain only 500 μg of targeted compound. For traditional NMR, i.e., not LC-NMR, one would prefer a purity level of at least 80%, where 90% or greater should be the target for isolation. Of course, the quantity of sample observed by NMR relates to the solubility in the selected solvent. Preliminary solubility tests, therefore, are important to identify an appropriate NMR solvent and hence maximize sensitivity. Related to purity is salt content. A large amount of salt in the sample, that is several times the amount of degradant, significantly changes the magnetic susceptibility of the sample. This may be beyond the tuning range of the probe and will therefore

make it challenging or impossible to tune and match the probe. The effect on the resulting data is poor resolution and coherence selection, which is essential for indirect detection experiments, as well as reduced sensitivity.

If information is available regarding stability, it is useful for appropriate sample handling. Possible sources of instability include light, heat, air, and stability in solution. Unfortunately, this information is usually not known *a priori*. Therefore, one should minimize risk by taking suitable precautions as described in Section V.D on sample preparation. Because this is an unknown research sample, safety hazards are also unknown, so one should proceed with at least the same level of caution that applies for the parent species.

The parent is often a useful starting point to assist in the interpretation of the NMR spectra of the unknown degradant or impurity. A sample of the parent compound ideally should be run in the same solvent used for the impurity for the most straightforward comparison, because chemical shifts and resolution may change somewhat in different solvents, particularly in the proton spectrum. Of course, solubility differences between the impurity and parent may preclude using the same solvent. Both the one-dimensional proton and carbon spectra of the parent should be obtained. Two-dimensional proton–carbon correlation spectra may also be needed to make all resonance assignments.

Additional information may come from a variety of sources. Certainly a proposed structure based on a plausible chemical structure and the total molecular mass is helpful. However, one must keep in mind that proposed structures are based on preliminary data only and thus may not be consistent with subsequently collected data. If LC–NMR is to be performed, then it is essential to obtain details of the method to be used. Other information may include color to suggest aromaticity, infrared (IR) absorption to detect carbonyl stretches, and relative chromatographic retention time to evaluate polarity compared to the parent.

C. NMR Instrumentation

The three main factors that determine the appropriate selection of NMR equipment are quantity, solubility, and stability. The quantity of sample determines the detection limits required. Because the quantity of sample is usually limited, it is important to identify the NMR probe that can accommodate the entire sample without unnecessarily diluting it in excessive solvent. The sample's solubility in the selected solvent is also important. Obviously one should choose a solvent that is highly soluble to maximize the amount of sample in solution. If the solubility is low, using a smaller sample tube size will not help to concentrate the sample. Last, stability is important, because we wish to ensure that the sample does not change over the course of acquiring the data. For unstable compounds, it may be necessary to separate additional degradants from the target species. For this purpose, chromatographic techniques can be combined with traditional NMR techniques.^{94–97}

Regardless of individual sample characteristics, there are several general instrumentation guidelines for performing the experiments described. Beginning with the NMR console itself, it is imperative that the system be able

to perform quadrature detection, because this significantly minimizes instrument artifacts that appear in the spectra.^{98,99} Antivibration legs reduce spectral noise that arises from floor vibrations. This is essential at high field strengths—400 MHz and above. Similarly, temperature control minimizes thermal instabilities, which may produce unwanted ridges in two-dimensional data sets. Temperature control is also useful for certain experiments such as the study of rotamers. Digital filtering capabilities, while not required, improve spectral quality of two-dimensional data sets by filtering out noise outside the spectral window.¹⁰⁰ A minimum field strength of 400 MHz is recommended to achieve the resolution and sensitivity necessary for reliable low-level impurity characterizations. The experiments described here are for protons and carbons, so two radiofrequency (also called RF) channels optimized for these frequencies are required. Ideally, one channel is dedicated to protons, while the other (sometimes designated X) channel covers a broad range of frequencies that include carbon. A Z axis gradient channel is recommended to significantly improve the coherence selection and hence the overall spectral quality of two-dimensional experiments.

Regarding general probe specifications, if the console is equipped with a gradient, then the NMR probe requires a corresponding gradient coil to accommodate it. A single Z axis gradient should suffice. The probe must also have at least two RF coils, one for protons and one for carbons or X nuclei, in addition to the deuterium coil used to lock the signal. Probes are designed such that one coil is concentrically inside the other. The inner coil yields the highest sensitivity. Therefore, for proton detection experiments, one ideally should choose a probe with the proton coil as the inner coil. This is called a broadband inverse probe, for an H–X probe. Alternatively, for optimal carbon detection, one should designate the X coil to be the inner coil, which is called a broadband observe probe. The field strength of the probe must also match that of the magnet; at least 400 MHz is recommended.

Several probe sizes are commercially available, and if one intends to do impurity and degradant characterizations routinely, it is valuable to have a representative range of sizes. The probe size is expressed in terms of the diameter of the sample tube for which it is designed. The most commonly used probe size is 5 mm. This is an appropriate choice if one is not limited by sample quantity. The sample size is ideally 25–50 mg in 0.5–0.75 mL of solvent, although as little as 1 mg of material can be used. Obviously increasing the sample concentration will reduce the experiment time required to obtain adequate signal-to-noise ratios.

If the amount of sample is limited, a good alternative is the family of “microprobes.” Microprobes are available in either 2.5- or 3-mm sizes. The sample volume is approximately 150 μL . This is suitable for samples on the order of 1 mg down to hundreds of micrograms. For smaller samples, on the order of tens to hundreds of micrograms, a “submicroprobe” is available.^{91–93} This probe, also known as a “SMIDGE” probe, is usually an inverse detection probe, in other words, it is optimized for proton detection. The tube diameter is 1.7 mm, which is the size of a standard capillary tube. It has an active volume of approximately 30 μL . Decreasing the sample tube size effectively concentrates the sample by reducing the amount of solvent required. Concentrating

the sample in the active coil region increases the number of spins detected and thus increases observed signal-to-noise ratios in the NMR spectra. Using a smaller tube size therefore will yield no significant advantage if there are solubility limitations preventing an increase in concentration. If solubility is very poor, the standard 5-mm probe affords the greatest ease of use.

Another probe choice is LC-NMR, which combines the mixture separation capabilities of liquid chromatography with the structural elucidation capabilities of NMR.^{94–97} To perform LC-NMR experiments, one must have both the LC accessory for the NMR console and an LC-NMR probe. The LC accessory consists of an LC system with either a variable wavelength UV detector or a diode array detector. It therefore requires a UV active chromophore for the targeted compound to be detected. An optional loop collector allows individual fractions to be stored for future NMR experiments. Individual fractions are sent to the LC-NMR probe, and NMR experiments that employ solvent suppression are performed. Currently the only available LC-NMR probes are optimized for proton detection, because the sensitivity prohibits reasonable carbon detection. Gradient capabilities greatly enhance solvent suppression and are therefore strongly recommended for an LC-NMR system. Sample sizes range from hundreds of micrograms down to hundreds of nanograms, although this lower limit is nontrivial to achieve. LC-NMR is suitable for unstable compounds, because it is able to separate multiple components in a sample mixture. The technique is limited by solvent suppression, which effectively “burns holes” in the spectrum at the solvent chemical shifts, thereby obscuring any sample signals in these regions. This, combined with its inherently low achievable sensitivity, makes it a secondary choice compared to other NMR alternatives.

D. Sample Preparation

Deuterated solvents are used in NMR for two reasons. First, deuterium provides a signal on which to lock the spectrometer frequency, thus enhancing long-term stability. Second, it dramatically reduces the proton signal that arises from the solvent, which would otherwise overwhelm the signal of the targeted compound. Solvents should be 99.9+% deuterated. If possible, it is recommended that 1-mL ampules rather than larger solvent bottles be used. This ensures the integrity of the solvent and avoids contamination during sample preparation. It also prevents absorption of water and deuterium exchange with hydrogen in air over time. Some common deuterated solvents used for NMR studies include dimethyl sulfoxide (DMSO), chloroform, methanol, water, acetone, and acetonitrile. DMSO is considered by many to be a “universal solvent,” since it provides excellent solubility for a wide variety of compounds. In addition, its high boiling point makes it ideal for variable temperature experiments, which are useful for dynamics studies. One point to note is that DMSO absorbs water over time, so care in storage conditions is essential. Protic solvents such as water and methanol provide proton sources for rapid exchange with labile protons. This makes NMR detection of species such as N–H and O–H protons impossible in these solvents. Also, some compounds, such as peroxides, may dissociate in protic solvents.

As we learned in our discussion of NMR instrumentation, the volume of solvent depends on the specific probe and tube size chosen. In general, one should minimize the total amount of solvent to concentrate the sample and hence increase the observed signal-to-noise ratio. Concurrently, adequate solvent must be used so that the sample height is above the top of the coil to ensure proper field homogeneity across the sample. Ideally the sample should be symmetric about the coil region for maximum field homogeneity. To minimize the degree of shimming required to achieve good resolution, the sample height should be roughly equal to that of the standard NMR sample used to create the shim file. Otherwise, there may be a significant difference in the shim values necessary to optimize the line shape. A standard proton sample used to measure resolution is 1%, by volume, chloroform in deuterated acetone. To properly reference the spectra, trimethylsilane (TMS) is often added as an internal reference standard. The chemical shift is set to 0.0 ppm for both protons and carbons. One must be extremely careful to add only a minuscule amount of TMS to the sample so as not to overwhelm the target signals. Typically not more than vapor is added. Alternatively, one can use the solvent signal itself as an internal reference for the chemical shift.

Clean glassware is essential for characterization of low-level impurities and degradants. Remember that one is probably working with the world's supply of the sample, so it is imperative to avoid contamination. For this reason, we recommend not reusing 5-mm NMR tubes for this purpose, but rather using a new tube for each impurity or degradant characterization. The justification is that the price of a 5-mm NMR tube is much less than the value of the sample. Similarly, we recommend not reusing 1.7-mm tubes for the same reason. In addition, thorough cleaning of 1.7-mm tubes is challenging. The cost of most 2.5- to 3-mm NMR tubes, however, is significant, so usually these tubes are reused. Special NMR tubes with plugs that are susceptibility-matched to particular solvents are also available. Use of these tubes can increase sensitivity, although they cost significantly more than traditional glass tubes. These tubes are always reused. For LC-NMR, disposable syringes are available as an alternative to cleaning glass syringes, although one must be certain that the sample is inert to the plastic material of the syringe. The LC-NMR system, including the probe and any loops to be used, should be washed for several minutes before use. The LC pump and degasser should be running for at least 30 min before use. Using deuterated solvents enhances detection capabilities by greatly reducing solvent signal contributions. This facilitates data interpretation.

Use safety precautions at least as rigorous as those for the parent species. To prepare the sample, use a pipette or syringe to place a minimal amount of solvent into the sample vessel. Samples should be prepared in the smallest vessel possible, preferably with a conical bottom, to reduce loss. The pipette should also be appropriately small to minimize sample loss. Use the pipette to dissolve as much of the sample as possible. Transfer this solution to the NMR tube (or small vessel for LC-NMR). Repeat until the desired solvent volume is used and the sample is completely transferred to the NMR tube. Cap or seal the tube. Inspect the tube for any residual solids. Solids decrease both the sensitivity and the resolution achievable and may produce a broad hump in the spectral baseline. To remove residual solids, warm the sample tube very

slightly by rolling it rapidly between the hands or by applying a heat gun at a distance. Use caution not to heat the sample significantly. Alternatively, one can filter the solution, but this may cause significant sample loss. Also, be sure that the degradant or impurity is not expected to react with the filter. Last, before placing the sample into the magnet, be sure to eliminate any air bubbles, because bubbles will make shimming more challenging and will cause adverse effects in the LC–NMR system.

To avoid instability, keep the sample out of light by covering it completely with aluminum foil when not in the magnet. To avoid thermal instability, do not heat the sample above ambient conditions. Keep the sample capped or sealed to minimize exposure to air. Dissolve the sample in solvent immediately before running the NMR experiments to evaluate its stability in solvent. Obtain a standard proton spectrum immediately after making up the sample as a stability reference. Obtain a second proton spectrum after the final NMR experiment to verify that sample integrity was maintained. Obtain another proton spectrum if any additional experiments are subsequently required.

E. NMR Experiments

I. Getting Started

Once the sample is prepared, load it into the magnet. Tune and match the probe for both protons and carbons, lock on the deuterium signal, and shim the probe. If the sample does not adequately tune or match, there may be an excessive amount of residual salt present, in which case the sample must be further purified. Spinning the sample improves resolution by reducing field inhomogeneities in the x-y plane. However, instabilities are introduced by the spinning itself, so one should never spin the sample for any long-term experiments, such as nuclear Overhauser effect measurements or two-dimensional experiments. The resolution improvement is trivial compared to the line width of carbon signals, so there is no advantage to spinning the sample when acquiring carbon detection data. The only case, therefore, when one may want to spin the sample is for a simple one-dimensional proton experiment. However, it is important to remember that spinning sideband signals arise in the proton spectrum at multiples of the spinning speed on either side of each observed resonance.¹⁰¹ The intensity of sideband signals depends on the quality of shimming. Poor shimming gives rise to more intense sideband signals. This may confuse the interpretation of the data, particularly when one is deciphering low-level contributions to the spectrum. We therefore recommend running all experiments described here without spinning the sample for ease of data interpretation and optimal stability. The experiments described here are based on the four-step CYCLOPS phase cycle to minimize unwanted quadrature image artefacts in the observed spectra.^{99, 102} For best results, the number of scans should therefore equal 2^N , where N is a positive integer. Depending on the amount of available sample, one should allow between 8 and 48 h to acquire and process the standard set of six experiments described below.

2. One-Dimensional Experiments

For all the one-dimensional (1-D) experiments described, the number of points should be enough to define the peaks in the spectrum. The transformed peaks should each have roughly 15 points defining them for reasonable resolution. The receiver gain can be set using the autogain feature of the NMR software. In general, the gain should be maximized to enhance sensitivity, while remaining below the limits of the receiver. If the signal is amplified beyond the receiver limits, the signal will be clipped in the time domain. The Fourier transform of the resulting square wave in the time domain is a sinc function in the frequency domain, which produces a detrimental wave pattern in the baseline.

The most basic NMR experiment is the one-pulse proton experiment.^{103,105} It comprises a 90° pulse on the proton channel followed by acquisition. The pulse duration should be set equal to the measured 90° proton pulse for the probe. The recycle time, or time between scans, should be greater than five times T_1 of the sample. A default value 1–2 s is often used. Proton chemical shifts typically range from 0–10 ppm, so the spectral width should be set to be at least this large. A good approach is to set the spectral width to a larger value, such as 15 ppm, to identify the actual limits of the resonances observed for a given sample. Then the spectral width can be reset to a smaller value more appropriate to the sample. Typically 4096 or 8192 (4K or 8K) points adequately cover a 10–12 ppm range. Acquiring an even number of scans minimizes unwanted quadrature image artifacts. Integrating each of the observed proton resonances is useful for data interpretation. Once the proton spectrum is integrated, one can estimate the sample purity to determine if further purification is necessary. There should be no more than roughly 20% contaminants in the sample.

The standard carbon experiment decouples protons from carbons to enhance sensitivity.¹⁰⁶ In the absence of proton decoupling, each carbon resonance is split by one more than the number of protons attached to that carbon. Because, unlike that for protons, the natural abundance of ^{13}C is only 1.1%, it is critical to maximize sensitivity to detect carbon in a reasonable amount of time.^{107,108} The most commonly used proton decoupling scheme is WALTZ-16.¹⁰⁹ Usually protons are the only nuclei that are decoupled in a standard carbon experiment. Other spin- $1/2$ nuclei, such as fluorine, are not decoupled and thus split each carbon resonance by one more than the number of attached fluorines (for example, see Fig. 26). This can be particularly advantageous for identifying fluorinated carbon entities. Because the carbon signals are often too weak to observe in a small number of scans, one needs to make a reasonable approximation for the spectral width. A standard carbon spectrum covers the range from 0 to 200 ppm with 32–64K data points. Because of the relatively long T_1 relaxation time of carbons, common practice is to use less than a full 90° pulse, such as a 30° pulse, and a recycle time of 0.2 s. A line broadening of 1 Hz improves sensitivity without significantly reducing resolution.

The distortionless enhanced polarization transfer (DEPT) experiment is a carbon selectivity experiment.^{110–116} Depending on the pulse length selected, one can selectively observe different types of carbon entities. We recommend setting the DEPT proton pulse length to 135°. In this case, quaternary carbons are suppressed, methylenes are inverted, and methine and methyl carbons

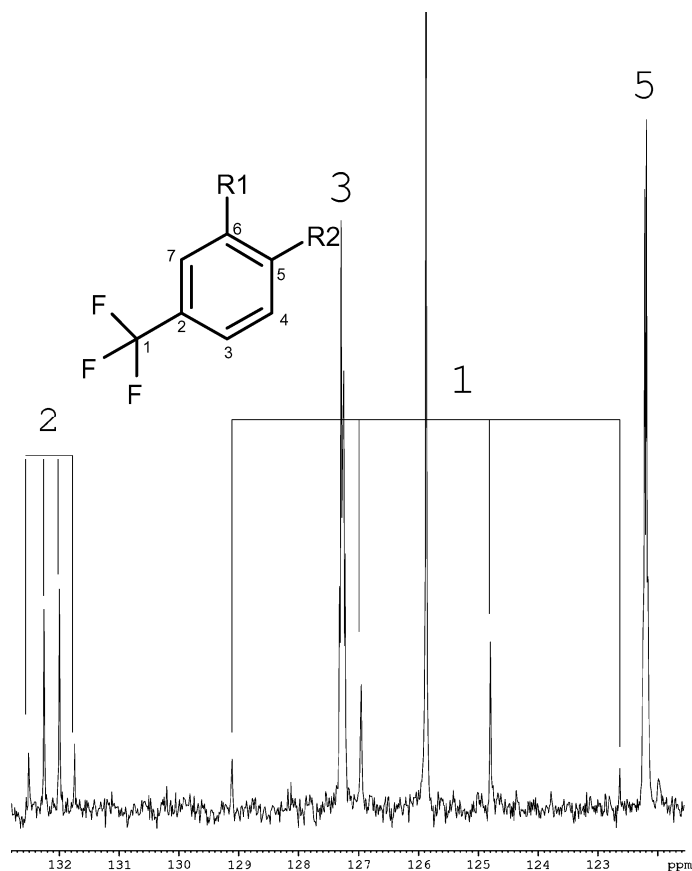

FIGURE 26 One-dimensional carbon spectrum showing splitting due to a trifluoro group. Notice that the affected resonances appear as quartets due to splitting by three equivalent spin- $1/2$ nuclei. The size of the coupling constant increases dramatically with proximity to the fluorines. This greatly facilitates the assignment of carbon resonances.

appear upright. Methines and methyls are distinguished based on chemical shift and two-dimensional proton correlations. Methines usually appear downfield of methyls. Alternatively, if time permits, the entire series of DEPT experiments can be performed to conclusively distinguish methine from methyl resonances. One second is a reasonable default value for the recycle time. The spectrum should be set to 0–200 ppm with 32–64K data points and four dummy scans.

3. Two-Dimensional Experiments

There are several general considerations for identifying appropriate two-dimensional (2-D) experiments to use for structural elucidation. First, most of the experiments described here are available both in gradient and nongradient versions. Gradients are used in these experiments to improve coherence selection that is otherwise performed using elaborate phase cycle schemes.^{117, 118} It is therefore possible to achieve improved signal selectivity and reduced spectral

artifacts with fewer acquisitions using gradient selection. Using two dummy scans before each acquisition establishes steady state equilibrium. The primary disadvantage of gradient coherence selection is reduced sensitivity. Therefore, if the low quantity of sample available requires a large number of scans for sensitivity reasons, one may prefer to use nongradient versions of the experiments described and instead rely upon phase cycling for signal selectivity.

On the topic of sensitivity, the two-dimensional experiments described here are all proton detection experiments. The reason is that protons are an abundant and hence easily detected nucleus, while ^{13}C has a low natural abundance and thus is more challenging to detect. The corresponding magnetogyric ratios also make protons more readily detectable than carbons. Experiments that traditionally were based on carbon detection thus often have modern day equivalent versions that transfer the carbon magnetization to protons and detect the corresponding proton signal. This is known as “inverse detection” or “indirect detection,” since the carbon signal is indirectly detected via its effect on the observed proton signal.^{119–122} Inverse detection experiments are particularly valuable for the characterization of impurities and degradants, since the sample quantity is often quite limited. For the 2-D experiments described here, the spectral width of the proton dimension should be equal to that determined for the 1-D proton spectrum, and the spectral width of the carbon dimension should be equal to that determined for the 1-D carbon spectrum. If the 1-D carbon spectral width has not yet been determined, then 0–200 ppm is a reasonable default range. Two dummy scans are used to establish a steady state equilibrium before each acquisition. A good compromise of data set size versus adequate resolution is 2048 points in the T_2 dimension and 512 points in the T_1 dimension. This data set size is appropriate for all the 2-D experiments described in this section.

The experiment traditionally used to detect proton–proton scalar couplings is known as a “COSY”^{117, 123} for correlation spectroscopy. The one-dimensional proton spectrum is shown along each of the two axes, and off-diagonal peaks show correlations between neighboring protons. Each proton also exhibits a correlation to itself, which appears along the diagonal axis of the spectrum. These self-correlation peaks do not provide any additional information and, depending on resolution limitations, may obscure cross peaks near the diagonal. It may therefore be advantageous to add a “double quantum filter” to the COSY experiment to reduce contributions along the diagonal. The double quantum filtered COSY (DQFCOSY)^{124–126} provides the same information as a standard COSY with improved resolution near the diagonal due to reduced self-correlation signals. For this homonuclear experiment, the spectral width is set equal to that of the 1-D proton spectrum in both dimensions. The recycle time is typically 1 s.

For heteronuclear correlations, HETCOR historically was the standard experiment used to detect proton–carbon scalar couplings.^{127–129} The disadvantage of HETCOR is that it is a carbon detection experiment. Therefore it has limited sensitivity as previously discussed. There are two modern inverse detection equivalent experiments for short range proton–carbon scalar couplings. They are heteronuclear single quantum coherence (HSQC)^{130–132} and heteronuclear multiple quantum coherence (HMQC).^{133–135} Both experi-

ments show the 1-D proton spectrum along T_2 and the 1-D carbon spectrum or projection along T_1 . Cross peaks correlate protons directly bonded to carbons. A proton resonance showing no correlations must be bonded onto a noncarbon entity, e.g., O—H or N—H groups. Similarly, a carbon resonance showing no correlations must be a quaternary carbon. This information is complementary to that obtained from the DEPT experiment, because one can also match proton integrals to corresponding carbons to distinguish methine, methylene, and methyl carbons. Since quaternary carbons are identified using the DEPT experiment, one can set the carbon spectral width of this 2-D experiment to only cover the protonated carbon region, nominally 0–180 ppm, to improve resolution in this dimension. Comparing the HSQC and HMQC experiments, the HSQC tends to yield higher resolution, while the HMQC tends to yield higher sensitivity. Thus, if sample quantity is limited, the HMQC is preferred. Otherwise, the HSQC is preferred. A coupling constant for $^1J(\text{C,H})$ of 145 Hz is recommended for either experiment. A 1-s recycle time should be sufficient.

Similar to the short-range correlation experiments described, a long-range scalar coupling experiment is also available. The heteronuclear multiple bond correlation experiment (HMBC) detects scalar couplings between protons and carbons that are separated by multiple bonds.^{122, 136–138} We recommend setting the long-range coupling constant, $^nJ(\text{C,H})$, to 10 Hz and the short-range coupling constant, $^1J(\text{C,H})$ to 145 Hz. The pulse sequence filters out contributions from short-range couplings. For aliphatic systems, correlations are typically observed between protons and carbons separated by two bonds. In aromatic systems, correlations are observed between protons and carbons separated by three bonds. Low-intensity $^2J(\text{C,H})$ correlations may also be observed in aromatic systems. (See, for example, Fig. 27.) Because the HMBC experiment detects weak couplings, it is an inherently insensitive technique. It is therefore wise to allow more time for acquisition of the HMBC compared with the previous experiments described. A 1-s recycle time should be sufficient. HMBC, combined with COSY or DQFCOSY, DEPT, HMQC or HSQC, and 1-D proton and carbon sequences comprise the standard set of experiments used as a first pass for structural elucidations of impurities and degradants.

4. Additional Experiments

If more information is required than is available from the standard set of experiments, one needs to perform additional experiments. One common example is if information regarding stereochemistry is necessary. The 2-D experiments previously described all relate to through bond correlations and not spatial relationships. One experiment that specifically addresses through space interactions is known as the nuclear Overhauser effect (nOe) experiment.^{139–142} The nOe experiment shows correlations between nuclei that are in close proximity to each other. A target signal is irradiated, and this alters the intensity of signals from neighboring nuclei. The resulting alteration of signal intensity is known as the nuclear Overhauser effect. Taking the difference between the irradiated spectrum and a standard spectrum leaves only the target signal, which is inverted, and the resulting nOes. This 1-D proton experiment requires very high instrument stability, so if available on the instrument,

it is useful to employ temperature control to ensure thermal stability. Sixteen dummy scans also ensure that a steady state equilibrium has been established.

Other common experiments include 1-D spectra of nitrogen, fluorine, oxygen, and other nuclei of pharmaceutical interest. However, with the exception of fluorine, these active nuclei have very low natural abundance which makes data acquisition extremely time consuming.¹⁰⁸ As we discussed earlier, fluorine couplings can be identified by splitting patterns in the 1-D carbon spectrum. For example, a trifluorinated carbon will appear as a quartet in the 1-D carbon spectrum. (See Fig. 26, for example.) The size of the coupling constant will determine the number of bonds separating the fluorine and carbon, since fewer bonds in between the two increase the strength of interaction and hence the size of the coupling constant. If pairs of peaks are observed in the 1-D spectra, this is often indicative of rotamers. Rotamers occur when the rotation about a bond, usually a nitrogen-carbon bond, is slow compared to the

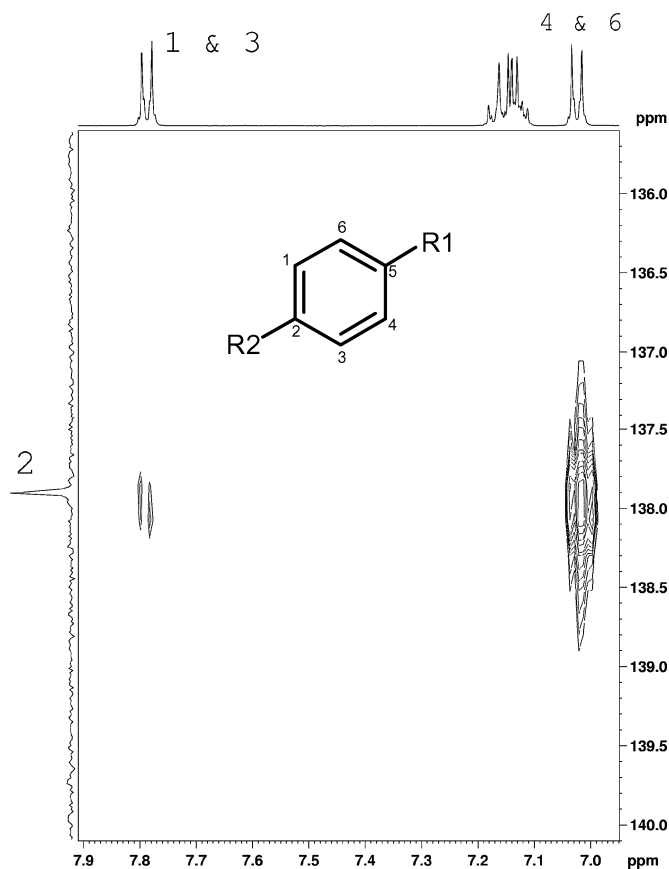

FIGURE 27 Comparison of strong and weak long-range scalar correlations in an HMBC spectrum. A strong intensity correlation is observed between carbon 2 and protons on 4 and 6, since the parameters are optimized for a three bond separation on an aromatic ring. A weak intensity correlation is observed between carbon 2 and protons on 1 and 3, since this corresponds to only a two-bond separation.

NMR time scale (microseconds to seconds). In this case, NMR observes two distinct yet equivalent entities. Elevating the temperature increases the rate of rotation such that, at the coalescence temperature, pairs of peaks coalesce to 1, and an average conformation is observed.¹⁴³ Another useful experiment addresses labile protons, such as N–H and O–H groups. The experiments described thus far detect proton–carbon and proton–proton interactions and do not specifically address protons bonded to other nuclei. As mentioned when discussing NMR solvents, the presence of protic solvents causes labile protons to exchange rapidly, rendering them unobservable by NMR. We can use this to our advantage. A proton spectrum is first acquired using an aprotic solvent. A few drops of deuterium oxide are then added to the sample, and the proton spectrum is reacquired. Labile protons will exchange with the D₂O and hence disappear from the spectrum. With this arsenal of techniques, we are now prepared to obtain sufficient data to begin elucidating a structure.

F. Data Interpretation

I. Primary Interpretation

A logical beginning is the one-dimensional proton and carbon spectra. Start by comparing the carbon spectrum with the DEPT spectrum to identify the number of protons attached to each carbon. It is useful when interpreting the data to label each carbon resonance as quaternary, methine, methylene, or methyl for easy reference. Next total the number of each type of carbon and compare these numbers to those for the parent. Remember that NMR detects only magnetically inequivalent species, so when counting carbons in the parent structure, be sure to count all equivalent carbons as only one unique carbon entity. Carbon peak intensities can provide some clues as to the number of magnetically equivalent carbons present, although proton integration is more quantitative. Methines will usually appear downfield of methyl carbons.¹⁴⁴ If a carbon resonance is in question, one can check the HMQC (or HSQC) spectrum and corresponding proton integration values for confirmation. The differences in carbon counts between the impurity and the parent will point out any obvious changes from the parent. These numbers can also be compared to the corresponding numbers for any proposed structures, which may rule out some possibilities immediately. A visual comparison between the parent and impurity carbon chemical shifts will also identify any obvious differences. This is especially useful, for example, when determining the oxidation site of an *N*-oxide or sulfoxide, since carbons neighboring the oxidation site will be shifted downfield compared to the corresponding peaks in the parent (see Fig. 28, for example). When comparing spectra, recall that minor differences may arise if different solvents are used. This is usually insignificant for carbon spectra but is more noticeable for proton spectra.

At this point, we are finished with the DEPT spectrum and can continue by identifying an appropriate starting point for specific assignments. There is inevitably at least one proton or carbon peak, and usually several, that one can assign immediately. This may be based on chemical shift. For example, a carbonyl should appear as a quaternary significantly downfield in the carbon spectrum, while aliphatic quaternaries appear significantly upfield. Carbon

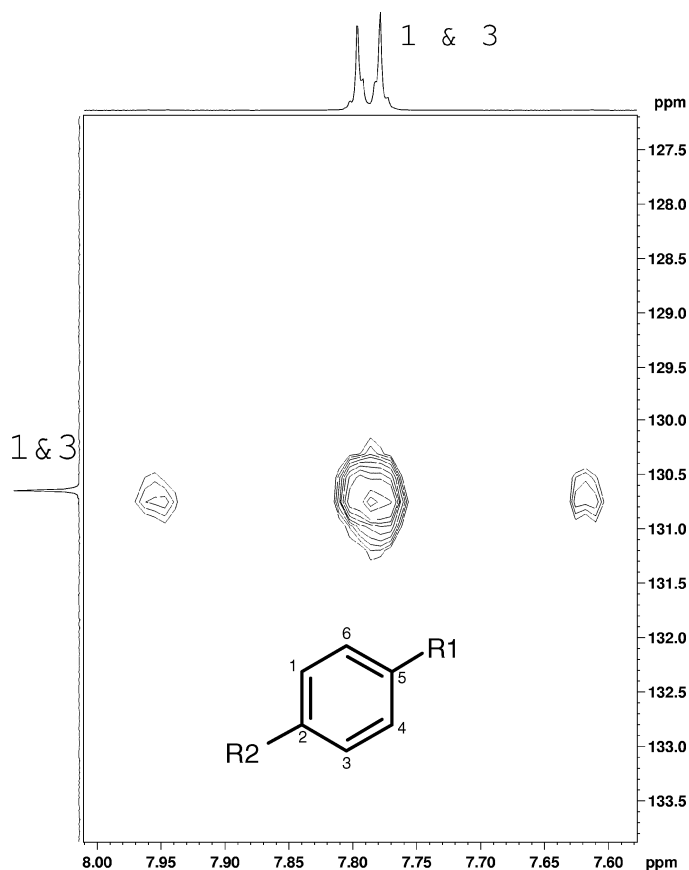

FIGURE 28 Comparison of carbon spectra for a parent compound and its associated *N*-oxide. Notice the carbons immediately neighboring the oxidation site are shifted downfield, and carbon 5 is significantly broadened. The upfield shift of carbons 2 and 3 reflects this shift in electron density.

multiplicities due to fluorine coupling are also excellent starting identifiers. Recall that the size of the coupling constant will determine the actual number of bonds separating the carbon and fluorine. In the proton spectrum, a particular peak may be assigned based on both chemical shift and integration. If no peaks can be identified using this approach, then it is necessary to go to the next step by looking at correlations as a unique identifier. For example, there may be two methyl triplets in the proton spectrum, but only one is expected to neighbor a methine as identified using the DQFCOSY spectrum (see Fig. 29, for example). A starting point needs to be identified for each spin system in the molecule. It is therefore useful to identify several starting points to facilitate assignments.

Once a starting point is identified, one can use the 2-D correlations to map out the rest of the structure. First, if starting with a protonated carbon group, use the HMQC to identify the proton directly bonded to the carbon or vice versa. The multiplicity of the proton resonance will identify the number of neighboring protons, since the multiplicity is equal to one more than

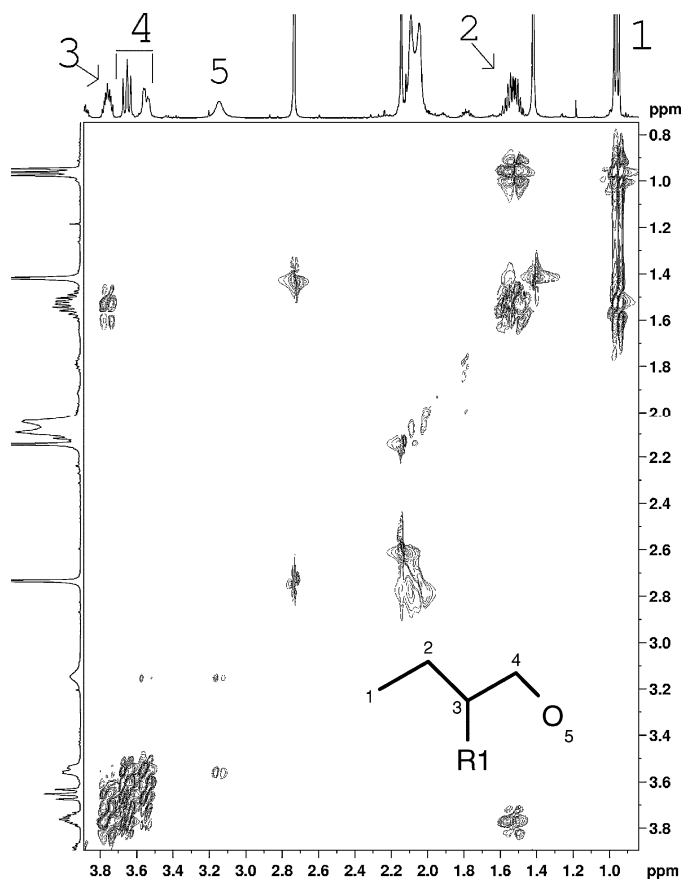

FIGURE 29 DQFCOSY spectrum of an extended spin system. Methyl 1 correlates to methylene 2, which neighbors methine 3. Methine 3 correlates to methylene 4, which in turn neighbors hydroxyl proton 5.

the number of neighboring protons.¹⁴⁵ This will help determine which carbon type is bonded to this carbon. Labile protons may only show weak couplings, so bear this in mind when evaluating proton multiplicities. Next use either the DQFCOSY or the HMBC spectrum to identify the neighbor (or neighbor once removed for long-range aromatic correlations). Remember that in the HMBC spectrum, for two protonated carbons correlated to each other, a cross peak will exist from the proton of the first to the carbon of the second. An additional cross peak will exist from the carbon of the first to the proton of the second (see, for instance, Fig. 30). This built-in redundancy of the HMBC is particularly useful when limited spectral resolution obscures a correlation peak. Of course, this redundancy is not possible for correlations to quaternary carbons, in which one must rely on observing a correlation from the quaternary carbon to the proton resonance of its neighbor. On the issue of redundancy, once all of the proton and carbon resonances have been assigned, it is a good idea to confirm that all of the observed 2-D correlations are consistent with the proposed assignments.

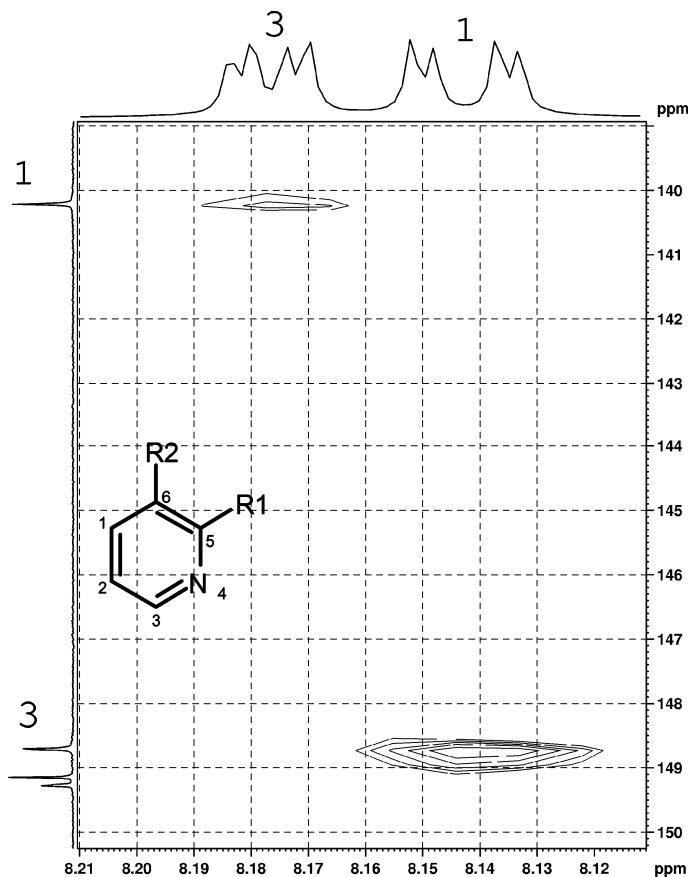

FIGURE 30 This HMBC spectrum shows that, for two protonated carbons correlated to each other, a cross peak will exist from the proton of the first to the carbon of the second, and an additional cross peak will exist from the carbon of the first to the proton of the second. Here we see a correlation between carbon 1 and proton 3 and an equivalent correlation between carbon 3 and proton 1.

Assignments based on 2-D correlations can often be confirmed by information found in the 1-D NMR spectra. For instance, if two protons neighbor each other as evidenced in the DQFCOSY spectrum, their proton resonances should show the same coupling constant. Aromatic ring protons often show an additional hyperfine splitting, which helps to distinguish ring protons from other electron-rich proton resonances. Labile protons found in N–H and O–H groups reduce the measured proton integration of these peaks. In addition, these proton resonances are broadened by the electron density of the X nucleus. (See, for example, Fig. 31.) This may make 2-D correlations to these groups too low in intensity to observe.

Once all the proton and carbon assignments have been made, one should have a reasonable picture of the actual structure. Recall that we have not directly investigated any nuclei other than protons and carbons, so be sure to keep in mind other possible heteroatoms that may be present. Certainly proton and carbon chemical shifts and correlations (or lack thereof) will pro-

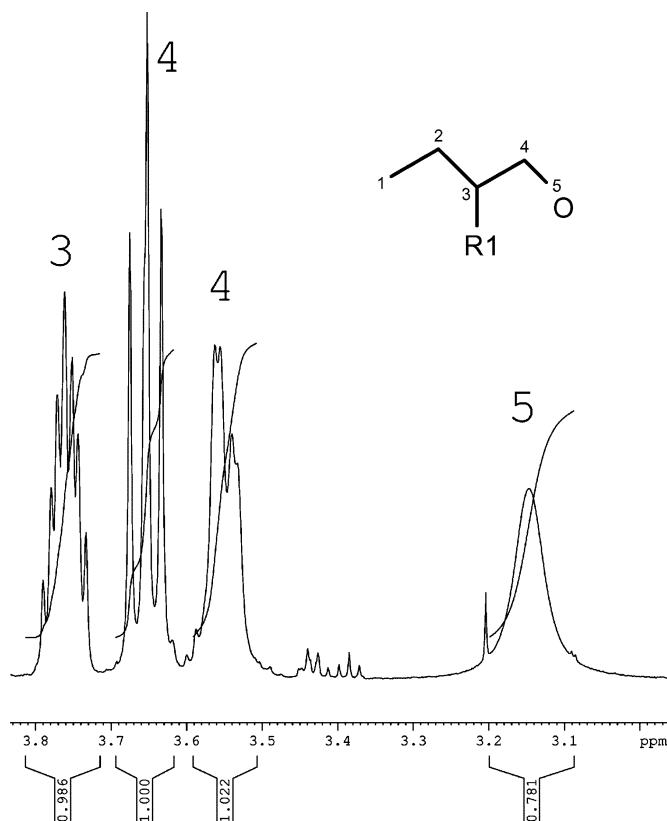

FIGURE 31 Labile protons found in N—H and O—H groups reduce the measured proton integration of these peaks. Here we see that the integration of the hydroxyl proton is less than the expected value of 1.00. Labile protons are broadened, as seen in the line width of resonance 5 compared to that of 3 and 4.

vide clues to the presence of other nuclei. Also, as previously discussed, NMR is limited to identifying magnetically inequivalent nuclei.¹⁴⁶ Therefore, the NMR spectra of a particular molecule often will be indistinguishable from the corresponding dimer, trimer, etc. Possible structures will therefore include these equivalent structures as well. We need to rely on molecular mass and other complimentary information to make this distinction. This brings us to the secondary interpretation.

2. Secondary Interpretation

As mentioned, for the structural elucidation of impurities and degradants, it is useful to compare the proton and carbon assignments to those of the parent compound. It will be immediately obvious which peaks have changed or disappeared. This will identify the site of degradation or reactivity. This is a valuable strategy for the determination of oxidation sites for *N*-oxides and sulfoxides (for instance, see Fig. 28). In either case, the carbon and proton resonances immediately neighboring the oxidation site should shift significantly downfield to reflect the enrichment of the electronic environment by the addi-

tion of oxygen. Also, any protons observed in the parent to be attached to the nitrogen will no longer be observed for the *N*-oxide. If there is no clear resemblance between the parent and impurity spectra at all, then the impurity may have derived from an alternative source. In this case, one should refer to the list of possible sources previously described to identify a likely candidate. One can then proceed in a similar fashion by comparing the proton and carbon assignments for the impurity to the corresponding chemical shifts for the excipient, precursor, or other identified source. Also, determine whether the parent or other source of the impurity sample was run as a salt form or a free base, because proton and carbon resonances may arise from the salt. These peaks should be easily identifiable by comparison to proton and carbon chemical shifts for known salts.

The next step is to compare the data and structural information obtained by NMR to any other information gathered. More specifically, is the structural information obtained by NMR consistent with any proposed structures? If not, identify the particular areas of inconsistency to propose new structures. Even if a structure is identified to be consistent with the NMR data, it is important to consider if any other structures may also be consistent with the data. As mentioned, NMR cannot distinguish magnetically equivalent nuclei, and the characterization strategy outlined here does not explicitly detect nuclei other than carbon and hydrogen. One may also use spectral simulations to lend credibility to a specific structure.¹⁴⁷ However, simulations should not be taken as proof of structure but rather be used to suggest plausible structures. The structure proposed based on the NMR data must be consistent with the total molecular mass, as determined by mass spectrometry. This is especially important for distinguishing monomers from dimers, trimers, etc.

At this point it is advantageous to reconvene with the characterization team to discuss the structural information obtained by NMR. Specifically, the group should identify areas of consistency or inconsistency of information gathered from other sources compared with the NMR conclusions. For example, the degradation site or other deviation from known compounds identified by NMR should be consistent with the location identified by mass spectral fragmentation patterns. It should be noted that there have been some cases in which the fragmentation was inconclusive for determining the reaction site. The proposed structure should also be consistent with any other information available, such as carbonyl stretches observed by IR and relative polarity determined by HPLC. If a structure has passed all the requirements thus far, one needs to determine if it can be derived from a plausible synthetic route. In other words, is it consistent with the reaction pathway and chemical entities present in the reaction vessel? If additional structural information is required, it is necessary at this point to identify appropriate follow-up experiments to perform. For example, if the stereochemistry at a chiral center is critical to the understanding of the system, nOe experiments may be useful to investigate spatial relationships. To improve the confidence level in a proposed structure, it may be necessary to synthesize the proposed structure using a well-established synthetic route and then repeat the NMR characterization on the synthesized compound. Comparing the proton and carbon spectra of the unknown with

the known compound should confirm consistency of structure. Finally, the team should draw conclusions based on the identified structure, including potential toxicity, plausible synthetic routes, and ways to prevent its formation.

VI. REFERENCE STANDARDS

An impurity is any component of a drug substance (excluding water) that is not the chemical entity defined as the drug substance. The impurity profile of a drug substance is a description of the impurities present in a typical lot of a drug substance produced by a given manufacturing process. The description includes the identity or some qualitative analytical designation (if identified), the range of each impurity observed, and the classification of each identified impurity.

The underlying assumption is that the analytical methods used to evaluate impurities in a drug substance are suitable for their intended purpose at each stage of development.¹⁴⁸

Whether the material is called an analytical reference standard, a working standard, or an authentic sample, material must eventually be supplied (preferably solid form) to the analyst to quantify impurities. Only with a sufficiently pure sample can the analyst accurately measure the response of an impurity in an assay. The impurity's molar absorptivity in a UV detector may differ widely from that of other components, resulting in either an underestimate or overestimate of its presence by HPLC. An impurity's response to developing sprays used in TLC is best quantified by comparison to known concentrations.

The sample should be as pure as possible, but standards have been used where the major constituent is approximately 85% of the mixture, as long as the remainder is made up of known compounds. Suggestions to use mixtures as reference standards have been made to reduce the number of assays run and the number of samples handled. This is clearly the case for a racemic mixture in an achiral HPLC assay, where both enantiomers have the same retention and detector response. It can also be beneficial to use known mixtures of diastereomers as a standard, provided there is sound reasoning that they give equivalent response to the method of detection.

A. The Process

Because reference standard material will eventually be consumed, replacement material must be isolated or synthesized. Due to this process, the method of preparing the standard should be reproducible for the future. Laboratory synthesis of a reference standard is preferred. The synthetic route does not have to be extremely efficient, since only 100–200 g will be required over several years. Preparative chromatography to acquire gram quantities can be practical where the separation is clean and the target compound is present above 3% in a concentrated mixture.

When the origin of the standard material is unique, the future source of the reference sample for a standardized test procedure may be in jeopardy.

For example, a concentrated source of an impurity may disappear if a chemical procedure is altered. An early production lot might have provided a waste product containing many grams of the impurity, and improvements to the reaction greatly reduced it. The need for the reference standard persists, but the source is gone. In this case, a new route to the impurity must be developed.

The first batch of reference standard usually evolves from an HPLC peak or a TLC band deemed to be present at a level important to the analyst. Assumptions must be made initially about response to a UV detector or to a TLC detection method. The best source of authentic material matching the peak or band of concern is from the process that led to the sample displaying the impurity. The development laboratory and/or the pilot plant is usually that source. LC-MS at this point can give a theoretical mass that may be informative. Enrichment of the impurity follows until the structure can be determined using other instrumentation.

B. Amount of Reference Standard

A small amount (0.1–2 g) of purified material matching the peak or band of interest may be sufficient. Identification of the impurity can lead to a chemical understanding of its source and later, to controls that eliminate or greatly reduce its presence. A small amount of pure sample may reveal a large molar absorptivity and lead to the conclusion that its level was greatly overestimated. The need for further material is thus eliminated. A moderate amount of material (2–25 g) may be enough to support all analytical efforts through New Drug Application filing. A large single lot sample (100–200 g) of a persistent impurity can provide consistency from early analytical work to quality control and support of manufacturing. The best way to determine the quantity of standard that will be required for a given impurity is to communicate with all groups that will use the standards.

The reference material is best provided as one lot to the analysts. Lot-to-lot variability is eliminated and the quality control unit can dispense samples with known stability. One designated storage location for all standards assures more accurate tracking of supplies over time and identifies the need for replenishing in an efficient manner. Multigram containers can be stored under the most favorable conditions then opened and subdivided when needed. A 3-year expiration period is assigned to the reference material unless there is evidence a shorter shelf life is needed. When expiration occurs, the remaining material need not be discarded. After simple laboratory procedures such as recrystallization and assignment of a new lot number, the material can again be qualified as a standard.

C. Isolation Approach Involving Reaction Enrichment

Intentional stress of the reaction conditions affording the active pharmaceutical ingredient may lead to greater levels of target impurities. The laboratory chemist can often alter conditions to have a detrimental effect on the intended product, steering the outcome to produce impurities. Varying temperatures,

concentration of reactants, or order of addition can give a rich source of impurities. It is important to simultaneously research as many potential impurities as possible to proceed efficiently. Interaction with all of the analysts on the project is critical. Any newly enriched HPLC peak may be of interest for additional assays. Knowledge of how to generate the impurity will be passed to the product development chemist so that detrimental conditions can be avoided.

Unstable compounds are problematic. A sample purified in the laboratory might have a short shelf-life and poor performance as a standard. Compounds altered by assays are also inconvenient. For example, substituted benzylic alcohols can dehydrate under acidic HPLC conditions, or carboxylic esters can hydrolyze in aqueous mobile phase. An impurity isolated from an active pharmaceutical ingredient as an organic salt of an organic compound poses two problems at once. The analyst must account for both the acid and the base. In the case of a toluenesulfonic acid salt of an aliphatic amine, two different methods of detection might be needed. The toluenesulfonic acid in a reverse-phase HPLC assay can be monitored by UV light, but the aliphatic amine, with no chromophore, must be measured by a different technique.

VII. SUMMARY

The objective of this chapter is to give guidance with residual solvents as well as degradation and impurity analysis for pharmaceutical drug candidates. Purposeful degradation knowledge is provided for guidance in developing and executing purposeful degradation experiments. A process for isolating and identifying process-related impurities and degradation products is also outlined herein. The identification of process-related impurities and degradation products provides an understanding of impurity formation and degradation mechanisms. If the identification process is performed at an early stage of drug development, there is adequate time for improvements in the drug substance process and drug product formulation to prevent these impurities and degradants from forming long before the filing stage when it is too late.

REFERENCES

1. International Conference on Harmonisation Steering Committee. *Impurities: Residual Solvents*. Federal Register 62(247) 67377 (1977).
2. Kovats, E. S. *Helv. Chim. Acta* 41:1915, 1958.
3. Zhou, X., Hines, P. A., White, K. C., and Borer, M. B. *Anal. Chem.* 70:390, 1998.
4. Loeper, J. M. and Grob, R. L. *J. Chromatogr.* 457:247, 1988.
5. Sadtler, P. and Sadtler, T. *Am. Lab.* 29(21), 1997.
6. Hampson, P. *Anal. Proc.* 21(6):208, 1894.
7. MacDonald, B. F. and Prebble, K. A. *J. Pharm. Biomed. Anal.* 11:1077, 1993.
8. MacLeod, S. K. *Anal. Chem.* 63:557A, 1991.
9. International Conference on Harmonisation Steering Committee. *Stability Testing of New Drug Substances and Products*, 1999.
10. *USP 24-NF 19*. The United States Pharmacopeial Convention, Inc., Rockville, MD, 1999.
11. US. Food and Drug Administration. *Drug Stability Guidelines*, February 1987.
12. Knapman, K. *Mod. Drug Discovery* 3:53–57, 2000.

13. Byrn, S., Pfeiffer, R., Ganey, M., Hoiberg, C., and Poochikian, G. *Pharm. Res.* 12:945–954, 1995.
14. Zollinger, H. *Color: A Multidisciplinary Approach*. Wiley-VCH, New York, 1999.
15. Lowry, T. H. and Richardson, K. S. *Mechanism and Theory in Organic Chemistry*, 3rd ed. Harper & Row, New York, 1987.
16. Ahuja, S. *Impurities Evaluation of Pharmaceuticals*. Marcel Dekker, New York, 1998.
17. Greenspan, L. *J. Res. the Natl. Bur. Stand. (U.S.)* 81A:89–96, 1977.
18. Carstensen, J. T. *Drug Stability Principles and Practices*, 2nd ed., Vol. 68. Marcel Dekker, New York, 1995.
19. Bordwell, F. G., Cheng, J., Ji, G., Satish, A. V., and Zhang, X. *J. Am. Chem. Soc.* 113:9790–9795, 1991.
20. Hudlicky, M. *Oxidations in Organic Chemistry*, ACS Monograph 186, American Chemical Society, Washington, DC, 1990.
21. Boccardi, G. *Farmaco* 49:431–435, 1994.
22. Howard, J. A. *Free Radicals*, Vol. II. John Wiley & Sons, New York, 1973.
23. Porter, N. A. *Membrane Lipid Oxidation*, Vol. 1. CRC Press, Boca Raton, FL, 1990.
24. Huyser, E. S. *Free Radical Chain Reactions*. Wiley-Interscience, New York, 1970.
25. Walling, C. *Tetrahedron* 41:3887, 1985.
26. Mollica, J. A., Ahuja, S., and Cohen, J. J. *Pharm. Sci.* 67:443–465, 1978.
27. Battino, R. *Oxygen and Ozone*, Vol. 7. Pergamon Press, Oxford, UK, 1981.
28. Tokunaga, J. J. *Chem. Eng. Data* 20:41–46, 1975.
29. Denisov, E. T. and Denisova, T. G. *Handbook of Antioxidants*. CRC Press, New York, 1999.
30. Ainley, W. and Weller, P. J. *Handbook of Pharmaceutical Excipients*, 2nd ed. The Pharmaceutical Press, 1994.
31. Barclay, L. R., Artz, J. D., and Mowat, J. J. *Biochim. Biophys. Acta* 1237:77–85, 1995.
32. Giulivi, C. and Cadenas, E. *Arch. Biochem. Biophys.* 303:152–158, 1993.
33. Liebler, D. C., Baker, P. F., and Kaysen, K. L. *J. Am. Chem. Soc.* 112:6995–7000, 1990.
34. Davies, M. J., Forni, L. G., and Willson, R. L. *Biochemistry* 255:513–522, 1988.
35. Moore, D. E. J. *Pharm. Biomed. Anal.* 5:441–453, 1987.
36. Allen, J. M. Basic principles of drug photostability testing. Presented at the *Photostability 1999 Conference*, Washington, DC, 1999.
37. International Conference on Harmonisation Steering Committee. *Photostability Testing of New Drug Substances and Products*, Federal Register 62(95), 27115–27 (1996).
38. Tonnesen, H. H. *Pharmazie* 46:263–265, 1991.
39. ISO, 1st ed., 1993.
40. Ryer, A. *Light Measurement Handbook*. International Light, Newburyport, MA, 1997.
41. Yoshioka, S., Ishihara, Y., Terazono, T., Tsunakawa, N., Murai, M., Yasuda, T., Kitamura, Kunihiro, Y., Sakai, K., Hirose, Y., Tonooka, K., Takayama, K., Imai, F., Godo, M., Matsuo, M., Nakamura, K., Aso, Y., Kojima, S., Takeda, Y., and Terao, T. *Drug Dev. Ind. Pharm.* 20:2049–2062, 1994.
42. Allen, J. M. *Principles of Actinometry*. Photostability 1999 Conference, Washington, DC, 1999.
43. Wirth, D. D., Baertschi, S. W., Johnson, R. A., Maple, S. R., Miller, M. S., Hallenbeck, D. K., and Gregg, S. M. *J. Pharm. Sci.* 87: 31–39, 1998.
44. Shaw, P. E., Tatum, J. H., and Berry, R. E. *Carbohydr. Res.* 5:266–273, 1967.
45. Jorgensen, W. L., Laird, E. R., Gushurst, A. J., Fleischer, J. M., Gothe, S. A., Helson, H. E., Paderes, G. D., and Sinclair, S. *Pure Appl. Chem.* 62:1921–1932, 1990.
46. Debesis, E., Boehlert, J. P., Givand, T. E., and Sheridan, J. C. *Pharm. Tech.* 6(9):120–137, 1982.
47. International Conference on Harmonisation Steering Committee. Draft Revised Guidance on *Impurities in New Drug Substances*, Federal Register 65(140), 45085–45090 (2000).
48. International Conference on Harmonisation Steering Committee. Draft Revised Guidance on *Impurities in New Drug Products*, Federal Register 65(137), 44791–44797 (2000).
49. Skoog, D. A. *Principles of Instrumental Analysis*, 3rd ed. Saunders College Publishing, Philadelphia, 1985.
50. Still, W. C., Kahn, M., and Mitra, A. *J. Org. Chem.* 43:2923, 1978.
51. Knox, J. H. and Pyper, H. M. *J. Chromatogr.* 363:1–30, 1986.

52. *Waters Preparative Liquid Chromatography Catalog*, Waters Corporation, 1998.
53. Porsch, B. J. *Chromatogr.* 658:179–194, 1994.
54. Carta, G. and Stringfield, W. B. *J. Chromatogr.* 658:407–417, 1994.
55. Colin, H., Hilaireau, P., and se Tournemire, J. 8:302–312, 1990.
56. Verzele, M., De Coninck, M., Vindevogel, J., and Dewaele, C. *J. Chromatogr.* 450:47–69, 1988.
57. Gervais, D. P., Laughinghouse, W. S., and Carta, G. *J. Chromatogr.* 708:41–53, 1995.
58. Thomson, J. J. *Philos. Mag.* 24:209, 1912.
59. Harrison, A. G. *Chemical Ionization Mass Spectrometry*, 2nd ed. CRC Press, Boca Raton, FL, 1992.
60. Wood, G. W. *Mass Spectrom. Rev.* 1:63–102, 1982.
61. Barber, M., Bordoli, R. S., Sedgwick, R. D., and Tyler, A. N. *J. Chem. Soc. Chem. Commun.* 325–326, 1981.
62. Surman, D. J. and Vickerman, J. C. *J. Chem. Soc. Chem. Commun.* 324–325, 1981.
63. Vestal, M. L. *Mass Spectrom. Rev.* 3:447–480, 1983.
64. Carroll, D. I., Dzidic, I., Stillwell, R. N., Haegele, K. D., and Horning, E. C. *Anal. Chem.* 47:2369–2373, 1975.
65. Yamashita, M. and Fenn, J. B. *J. Phys. Chem.* 88:4452–4459, 1984.
66. Hillenkamp, F. and Karas, M. *Methods Enzymol.* 193:280–294, 1990.
67. McLafferty, F. W. *Tandem Mass Spectrometry*. Wiley-Interscience, New York, 1983.
68. Sharp, T. R. and Horan, G. J. Presented at *45th ASMS Conference on Mass Spectrometry and Allied Topics*, Palm Springs, CA, 1997.
69. D'Agostino, P. A., Hancock, J. R., and Provost, L. R. *Rapid Commun. Mass Spectrom.* 9:1038–1043, 1995.
70. Colorado, A. and Brodbelt, J. *Anal. Chem.* 66:2330–2335, 1994.
71. Kowalski, M. H., Sharp, T. R., and Stang, P. J. *Org. Mass Spectrom.* 22:642–643, 1987.
72. DeBievre, P. and Barnes, I. L. *Int. J. Mass Spectrom. Ion Processes* 65:211–230, 1985.
73. Sharp, T. R., Smith, D. E., Heah, P. C., Buhro, W. E., Crocco, G. L., Bodner, G. S., Fernandez, J. M., and Gladysz, J. A. *Adv. Mass Spectrom.* 10B:1359–1360, 1986.
74. Sharp, T. R., Lee, H., Ferguson, A., Marsh, K. N., and Harvey, R. G. Presented at the *36th Annual Conference on Mass Spectrometry and Allied Topics*, 1988.
75. Beynon, J. H. *Nature (Lond.)* 174:735, 1954.
76. Kondrat, R. *J. Am. Soc. Mass Spectrom.* 10:661, 1999.
77. Busch, K. L. *Spectroscopy* 9(7):21–22, 1994.
78. Biemann, K. *Methods Enzymol.* 193:295–304, 1990.
79. *Journal of Organic Chemistry* 58:7A–12A, 1993; 65:14A–19A, 2000.
80. Any recent issue of the *Journal of the American Society for Mass Spectrometry*.
81. Gilliam, J. M., Landis, P. W., and Occolowitz, J. L. *Anal. Chem.* 55:1531–1533, 1983.
82. Gilliam, J. M., Landis, P. W., and Occolowitz, J. L. *Anal. Chem.* 56:2285–2288, 1984.
83. Budzikiewicz, H., Djerassi, C., and Williams, D. H. *Mass Spectrometry of Organic Compounds*. Holden-Day, San Francisco, 1967.
84. Porter, Q. N. *Mass Spectrometry of Heterocyclic Compounds*, 2nd ed. John Wiley & Sons, New York, 1985.
85. McLafferty, F. W. and Venkataraghavan, R. *Mass Spectral Correlations*, 2nd ed., Advances in Chemistry Series 40. American Chemical Society, Washington, DC, 1982.
86. Derome, A. E. *Modern NMR Techniques for Chemistry Research*. Pergamon Press, Oxford, UK, 1987.
87. Ernst, R. R. *Principles of Nuclear Magnetic Resonance in One and Two Dimensions*. Clarendon Press, Oxford, UK, 1987.
88. Abragam, A. *Principles of Nuclear Magnetism*. Clarendon Press, Oxford, UK, 1989.
89. Slichter, C. P. *Principles of Magnetic Resonance*, 3rd ed. Springer-Verlag, Berlin, 1990.
90. Harris, R. K. *Nuclear Magnetic Resonance Spectroscopy*. Longman Scientific & Technical, New York, 1990.
91. Martin, G. E., Crouch, R. C., and Zens, A. P. *Magn. Reson. Chem.* 36:551–557, 1998.
92. Martin, G. E., Guido, J. E., Robins, R. H., Sharef, M. H. M., Schiff, P. L., Jr., and Tackie, A. N. *J. Nat. Prod.* 61:555–559, 1998.
93. Martin, G. E., Hadden, C. E., Tackie, A. N., Sharaf, M. H. M., and Schiff, P. L., Jr. *Magn. Reson. Chem.* 37:529–537, 1999.

94. Kaerner, A., Dow, L., Jackson, D., and Borel, A. Recent development and applications of HPLC–NMR for structural elucidation. Presented at the *41st ENC Conference*, Pacific Grove, CA, 2000.
95. Kaerner, A. and Maple, S. The development and applications of exact mass HPLC–NMR–MS. Presented at the *41st ENC Conference*, Pacific Grove, CA, 2000.
96. Farrant, R. D., Mills, G., and Walker, V. Identification of the Species Produced by the Reaction of P5C and Puridoxal Phosphate Using LC–NMR–MS. Presented at the *41st ENC Conference*, Pacific Grove, CA, 2000.
97. Olson, D. L. Trace Analysis Using Capillary HPLC–NMR. Presented at the *2nd SMASH NMR Conference*, Argonne, IL, 2000.
98. Derome, A. E. *Modern NMR Techniques for Chemistry Research*. pp. 77–80. Pergamon Press, Oxford, UK, 1987.
99. Traficante, D. D. *Concepts Mag. Reson.* 3:181–195, 1990.
100. Braun, S., Kalinowski, H.-O., and Berger, S. *150 and More Basic NMR Experiments*, p. 55. Wiley-VCH, Weinheim, 1998.
101. Derome, A. E. *Modern NMR Techniques for Chemistry Research*, p. 41. Pergamon Press, Oxford, UK, 1987.
102. Derome, A. E. *Modern NMR Techniques for Chemistry Research*, pp. 77–82. Pergamon Press, Oxford, UK, 1987.
103. Sanders, K. K. and Hunter, B. K. *Modern NMR Chemistry*, 2nd ed. Oxford University Press, Oxford, UK, 1993.
104. Friebolin, H. P. *Basic One- and Two-Dimensional NMR Spectroscopy*, 2nd ed. VCH, Weinheim, 1993.
105. Braun, S., Kalinowski, H.-O., and Berger, S. *150 and More Basic NMR Experiments*, pp. 45–49. Wiley-VCH, Weinheim, 1998.
106. Kalinowski, H.-O., Berger, S., and Braun, S. *Carbon-13 NMR Spectroscopy*. John Wiley & Sons, Chichester, UK, 1988.
107. Braun, S., Kalinowski, H.-O., and Berger, S. *150 and More Basic NMR Experiments*, pp. 50–54. Wiley-VCH, Weinheim, 1998.
108. Harris, R. K. *Nuclear Magnetic Resonance Spectroscopy*, p. 236. Longman Scientific & Technical, New York, 1990.
109. Shaka, A. J., Keeler, J., and Freeman, R. *J. Mag. Reson.* 53:313–340, 1983.
110. Bendall, M. R., Pegg, D. T., Doddrell, D. M., and Field, J. *J. Mag. Reson.* 53:520–526, 1983.
111. Bendall, M. R. and Pegg, D. T. *J. Mag. Reson.* 53:40–48, 1983.
112. Bendall, M. R. and Pegg, D. T. *J. Mag. Reson.* 53:272–296, 1983.
113. Derome, A. E. *Modern NMR Techniques for Chemistry Research*, pp. 143–151. Pergamon Press, Oxford, UK, 1987.
114. Schenker, K. V. and Philipsborn, W. V. *J. Mag. Reson.* 66:219–229, 1986.
115. Doddrell, D. M., Pegg, D. T., and Bendall, M. R. *J. Mag. Reson.* 48:323–327, 1982.
116. Braun, S., Kalinowski, H.-O., and Berger, S. *150 and More Basic NMR Experiments*, pp. 180–182. Wiley-VCH, Weinheim, 1998.
117. Hurd, R. E. *J. Mag. Reson.* 87:422–428, 1990.
118. Tolman, J. R., Chung, J., and Prestegard, J. H. *J. Mag. Reson.* 98:462–467, 1992.
119. Tyburn, J. M., Brereton, I. M., and Doddrell, D. M. *J. Mag. Reson.* 97:305, 1991.
120. Vuister, G. W., Boelens, R., Kaptein, R., Hurd, R. E., John, B. K., and van Zijl, P. C. M. *J. Am. Chem. Soc.* 113:9688, 1991.
121. Hurd, R. E. and John, B. K. *J. Mag. Reson.* 91:648, 1991.
122. Willker, W., Leibfritz, D., Kerschebaum, R., and Bermel, W. *J. Mag. Reson.* 31:287–292, 1993.
123. Jeener, J. *Ampere International Summer School, proposal*. Basko Polje, 1971.
124. Piantini, U., Sorensen, O. W., and Ernst, R. R. *J. Am. Chem. Soc.* 104:6800–6801, 1982.
125. Brereton, I. M., Crozier, S., Field, J., and Doddrell, D. M. *J. Magn. Reson.* 93:54–62, 1991.
126. Braun, S., Kalinowski, H.-O., and Berger, S. *150 and More Basic NMR Experiments*, pp. 168–371. Wiley-VCH, Weinheim, 1998.
127. Martin, G. E. and Zektzer, A. S. *Two-Dimensional NMR Methods for Establishing Molecular Connectivity*, Chap. 3. VCH, Weinheim, 1988.
128. Bax, A. and Morris, G. A. *J. Mag. Reson.* 42:501–505, 1981.

129. Freeman, R. and Morris, G. A. *J. Chem. Soc. Chem. Commun.* 684–686, 1978.
130. Bodenhausen, G. and Ruben, D. J. *Chem. Phys. Lett.* 69:185–188, 1980.
131. Braun, S., Kalinowski, H.-O., and Berger, S. *150 and More Basic NMR Experiments*, pp. 397–400. Wiley-VCH, Weinheim, 1998.
132. Kay, L. E., Keifer, P., and Saarinen, T. *J. Am. Chem. Soc.* 114:10663–10665, 1992.
133. Muller, L. *J. Am. Chem. Soc.* 101:4481–4484, 1979.
134. Braun, S., Kalinowski, H.-O., and Berger, S. *150 and More Basic NMR Experiments*, pp. 384–387. Wiley-VCH, Weinheim, 1998.
135. Hurd, R. E. and John, B. K. *J. Magn. Reson.* 91:648–653, 1991.
136. Bax, A. and Summers, M. F. *J. Am. Chem. Soc.* 108:2093–2094, 1986.
137. Ruiz-Cabello, J., Vuister, G. W., Moonen, C. T., van Gelderen, P., Cohen, J. S., and van Zijl, P. C. M. *J. Mag. Reson.* 100:282–303, 1992.
138. Martin, G. E. and Zektzer, A. S. *Two-Dimensional NMR Methods for Establishing Molecular Connectivity*, pp. 267–273. VCH, Weinheim, 1988.
139. Kinns, M. and Sanders, J. K. M. *J. Mag. Reson.* 56:518–520, 1984.
140. Neuhaus, D. and Williamson, M. *The Nuclear Overhauser Effect*. VCH, Weinheim, 1989.
141. Derome, A. E. *Modern NMR Techniques for Chemistry Research*, pp. 97–127. Pergamon Press, Oxford, UK, 1987.
142. Noggle, J. H. and Schirmer, R. E. *The Nuclear Overhauser Effect—Chemical Applications*. Academic Press, San Diego, 1972.
143. Harris, R. K. *Nuclear Magnetic Resonance Spectroscopy*, pp. 119–131. Longman Scientific & Technical, New York, 1990.
144. Abraham, R. J., Fisher, J., and Loftus, P. *Introduction to NMR Spectroscopy*, pp. 16–26. John Wiley & Sons, Chichester, UK, 1988.
145. Harris, R. K. *Nuclear Magnetic Resonance Spectroscopy*, p. 26. Longman Scientific & Technical, New York, 1990.
146. Abragam, A. *Principles of Nuclear Magnetism*, pp. 480–481. Clarendon Press, Oxford, UK, 1989.
147. Williams, T., Blinov, K., Elyashberg, M., and Martirosian, E. Recent Advances in the Use of NMR Prediction and Automated Structure Elucidation Software for Natural Product Characterization. Presented at the *SMASH NMR Conference*, Argonne, IL, 2000.
148. *USP 24–NF 19*, Section 1086. The United States Pharmacopeial Convention, Rockville, MD, 1999.

5

PREFORMULATION STUDIES

EDWARD LAU (deceased)

E.L. Associates, Wilmington, DE 19807

- I. INTRODUCTION
 - A. Product Development of a New Drug Entity
 - B. Preformulation Study in Support of New Drug Product Development
- II. PREFORMULATION STUDIES
 - A. Need for a Preformulation Study
 - B. Stages of Preformulation Studies
 - C. Preformulation Study for Drugs and Health-Care Products
 - D. Preformulation Report
 - E. Format of the Preformulation Report
- III. ANALYTICAL TECHNIQUES AND INSTRUMENTS FOR PREFORMULATION STUDIES
 - A. Specific Detection
 - B. Separation Sciences
 - C. Thermal Analytical Methods
- IV. REGULATORY REQUIREMENTS FOR PREFORMULATION
 - A. Regulatory Compliance
 - B. Quality Control for a Preformulation Study
- V. SUMMARY AND CONCLUSIONS
- APPENDIX 1
- APPENDIX 2
- APPENDIX 3
- REFERENCES

I. INTRODUCTION

For the past five decades, scientific data collectively known as preformulation studies have been developed for supporting the dosage form design of a new drug and its quality control. Preformulation studies gained momentum in the 1950s and imposed scientific principles and rationale on formulation development to minimize trial-and-error efforts. Before the advent of preformulation study, developing the dosage form depended on the formulator's experience, some knowledge of the excipients used, and the basic, functional product testing. Such a study is built on a knowledge of physical pharmacy, the study of physical and chemical principles of pharmaceutical science,¹ and biopharmaceutics, the study of the influence of formulation on the therapeutic availability of a drug product.²

In the pharmaceutical industry, preformulation is not generally carried out by one department alone. This activity integrates efforts of well-coordinated tasks among many research teams: analytical research, basic pharmaceuticals, quality control, dosage forms development, and others throughout the

development cycle. Because there is a close relationship between preformulation and the development cycle, the cycle must be well understood.

The cycle for modern pharmaceutical product development involves preformulation studies along with regulatory compliance for marketing success. This chapter incorporates scientific management and industrial perspectives with scientific approaches. Food and Drug Administration (FDA) involvement and vigilance related to regulatory compliance are noted. This chapter convenes reference sources for the theoretical aspects of testing. The information outlines contents for a thorough preformulation report. Discussion of scientific principles and theoretical fundamentals for testing procedures are brief, as these presentations can be found in textbooks or review papers. However, testing methods, current advances, regulatory requirements, and development contributions are explicitly discussed.

A. Product Development of a New Drug Entity

The process of bringing a new drug product onto the pharmaceutical market has evolved into a well-defined system within the global pharmaceutical industry. Generally, a new drug molecule intended for a certain therapeutic area has been chosen from a screening program in the drug discovery stage, meeting the preselected biological and therapeutic criteria with evidence of good performance. In some instances, a molecule of the lead compound may be modified chemically or physicochemically to enhance its therapeutic properties.

Upon satisfactory completion of the criteria, the drug is further assessed and nominated as a candidate for future development by a product selection committee for market introduction. The selection process is a team-effort, multiple-discipline decision. Members of the team represent a cross section of corporate functional organizations, such as research and development (R&D), production, marketing, medical, and quality assurance/quality control (QA/QC) departments of the company.

Regulatory development processes entailing investigational new drug (IND) application, new drug application (NDA), or abbreviated new drug application (ANDA) may be followed after the identification process for development candidates. This beginning commitment to a new drug is succeeded by various stages in the development process from discovery research to market introduction. The time required for completion is commonly 4 to 12 years, with the success rate of bringing a developed compound to the market estimated at 10%.

B. Preformulation Study in Support of New Drug Product Development

The journey of development from the discovery of a new active drug to a pharmaceutical product is lengthy. Although the financial reward for a successful product is great, the failure rate of bringing a product into the market is extremely high. Also to be considered are the varied and unpredictable investment in time and expenditures on an unsuccessful product. Termination of a project depends on the results of continuing experimentation. Thus, constant focus on the development events is essential for making critical decisions. The

essential project management team must track progress, provide distribution of resources, and make rapid managerial decisions for business success.

A typical development track activity for preformulation monitoring may be divided into several phases, as discussed in the following.

I. Selection of a Drug Substance for Dosage Form Development

In the biological screening of chemical compounds, a chemical entity is identified as a candidate for development. The selected compound as tested during screening may not be the ideal compound for further development, as outlined next.

a. Structure Modifications

In many instances, modification of the chemical structure or physical property may prove to optimize the therapeutic and pharmaceutical values of the candidate. A series of preformulation investigations must be performed to ensure that the change in the molecule is required and justified.

b. Purity

Optimal purity of a development compound in the early stage may not be necessary as the purification process continues to be improved. The level of purity of substances used for the discovery and early development stages should be practical, depending on the prevailing stage of synthesis. However, the purity profile must be established, and quality consistency must be enforced. The final progress in synthesis must be based on a commitment to ultimate quality with highest purity.

c. Chirality

Chirality is the existence of different configurations of a substance with an identical chemical structure. This substance may be resolved into enantiomers with nonsuperimposable mirror images. Thus, a chemical substance having two isomers is known as a chiral compound. Chiral substances having a 50:50 mixture of the two enantiomers are known as racemic.

Frequently one of the enantiomers does not have active pharmacologic properties. In such a case, the drug formulation should not include a chemical moiety that does not have therapeutic value once the separation technique is available and is considered to be economical. In addition to physiological activities, stereospecificity influences the physicochemical properties of drugs. Let's take as an example the enantiomer of ibuprofen compared with the racemate. The chiral compound has higher aqueous solubility, higher density, and better flowability, but a lower intrinsic dissolution rate.³

For development of a new chemical entity, the resolution of an optically active compound should be available in an earlier stage of the discovery process of the preformulation study. Selection of the enantiopure component or racemic mixtures to be a market product must be decided before patent application and IND submission. Heavy investment in the wrong chiral compounds may be lost if another enantiomer is to be developed.

d. Salt Forms Selection

Many synthetic substances to be used in solid dosage form are too limited in solubility to be therapeutically effective. The desirable solubility for an oral solid is suggested to be more than 1 mg/ml (0.1%). To increase solubility, a weak basic drug such as an amine may react with respective mineral acids to form salts, that is, hydrochloride (more than 40% of the salt marketed), sulfate, or phosphate. For an amine with two functional groups, a mono- or dihydrochloride salt may be formed, depending on the condition and amount of hydrochloric acid added. For an organic acid, a salt with sodium or potassium can easily be formed. Because a molecule of salt is polar, it should be freely soluble in water, reaching a therapeutic solubility level. The other types of acids commonly used for salt formation with a weak base are sulfonic acids and carboxylic acids.

For semisolid dosage forms such as ointments and creams, an organic acid derivative of a base is used to produce an oily substance that circumvents formulation problems and enhances drug partitioning through the skin. Organic acid salts such as oleate, octanoate, or undecylenate are used for this purpose.

To assist in the selection of the salts for the final drug substance for IND and subsequent NDA, a number of salts based on available information must be prepared and tested in the preformulation program with the following properties taken into account:

- Solubility (according to therapeutic purpose)
- Hygroscopicity
- Bioavailability
- Stability

An *in situ* salt screening technique for basic drugs has also been reported.⁴ The solubilities obtained by this technique are in agreement with those of the authentic compounds. Selection of the proper salt improved the manufacturing, stability, and bioavailability of the dosage forms. Following are examples illustrating the effects of selecting the proper salt form during preformulation:

- The free base of amonifide has undesirable processing properties, including high porosity, low compressibility, and bad flow properties. Replacing the free base with its dihydrochloride salt improved its processing in direct tablet compression.⁵
- The hydrochloride salt of REV-5901 revealed instability due to anhydrous monohydrate conversion of the salt form.⁶
- Various salts, sodium, potassium, hydrogen sulfate, phosphate, and chloride, of RS-82856 were prepared with the preformulation parameters; solubility, hygroscopicity, and intrinsic dissolution rate were also determined. The hydrogen sulfate salt was chosen as the candidate because of the twofold increase in bioavailability when compared with the parent compound.⁷

e. Prodrugs

As discussed previously, the design of solid dosage forms depends on bioavailability, which is controlled by the processes of dissolution and absorption.

Although a drug substance may dissolve rapidly, adsorption may be slow in some instances, reducing bioavailability.

Manipulation of the lipophilicity of a molecule, such as by the formation of an ester, may increase the rate of its absorption through the gastrointestinal (GI) tract. The esterified molecule is subsequently converted back to the original molecule after transport through the GI tract. The esterified molecule, which may readily hydrolyze back to the parent molecule, is known as a prodrug.

On the other hand, formation of a prodrug such as a phosphate ester may increase hydrophilicity, thus enhancing solubility. For example, the solubility and dissolution rate of the *n*-hydroxymethyl derivative of lomefloxacin is higher than those of the parent compound, and it can be converted readily back to the original molecule.⁸ Commonly used prodrugs are procaine penicillin metronidazole phosphate and chloramphenicol sodium succinate.

f. Metabolites

The metabolism study of a drug candidate should be carried out in the earlier stage of development soon after the selection process. The major metabolites should be tested pharmacologically and toxicologically against the candidate. If similar profiles are found, consideration should be given to replacing the original drug candidate with its metabolite.

2. Intellectual Property Protection and Patent Filing

Ensuring the market exclusivity rights for a new drug as protected intellectual property is of ultimate importance. Intellectual property is generally of four types:

- Patents: protection of useful inventions, which may be processes, machines, articles of manufacture, or composition of matter
- Copyrights: protection of the original expression of an idea fixed in a tangible medium of expression
- Trade secrets: almost anything that is not generally known and that gives the owner a competitive business advantage. The owner must take precautions to ensure that the trade secret remains a secret.
- Trademarks: identifying a product and distinguishing it from others

Of these, patent filing is used more extensively and, therefore, is important to the market exclusivity protection of a drug product.⁹ A patent application is sometimes an afterthought when the invention is already a reality. An inventor rarely studies patent law before inventing. More often, invention is based on ingenuity and a perceived need for the product. Patent protection most often becomes a negotiation process to attain eligibility after the process of invention.

In contrast to the majority of inventors, pharmaceutical companies anticipate the prerequisites of patent application before discovery. In fact, the strategic plan in drug development includes the details of a successful patent assignment. Application requirements are well defined and known. The rules of record keeping and legal verification in the notebook format by the discovery chemist are well documented. Extensive synthesis of a series of analogues

for an intended compound is realized, and biological activities are characterized. Other physical properties generated from the preformulation study such as chirality and polymorphism are well documented to cover future patent infringement.

3. Selection of Analytical Technique and Development

Analytical techniques are fundamental to new drug development. Without them, no evaluation of the quality of materials, product precursors, or final product can be made. No biological or pharmacologic responses in the preclinical or clinical stages can be measured. Analytical methods must be developed early and before the product development stage, and often in the drug discovery stage. Methods may be improved and optimized as the study progresses. These methods must be qualified and, in some cases, validated according to the regulatory requirements before use in investigational studies. Selection of analytical techniques should be based on the elements of the study; specificity, accuracy, precision, sensitivity, and speed of a test must be justified for the method selected.

4. Preparation and Submission of IND

To gain regulatory approval for the initiation of a clinical study, an IND application must be prepared and submitted to the FDA. An IND is an application to the FDA to obtain exemption from the status that prohibits an unapproved drug from being shipped via interstate commerce. This is the precursor of an NDA, part of the regulatory process toward marketing approval of a new drug. IND requires three major types of documentation:

- Animal toxicology and pharmacology
- Clinical protocol and investigator qualifications
- Chemistry, manufacturing, and control (CMC), where some physico-chemical information of the drug (referred to as preformulation studies) is required

5. Clinical Trial Studies

Clinical studies must comply with Good Clinical Practice (GCP), and the preparation of clinical supplies must be regulated by current Good Manufacturing Practices (cGMP).

During the preparation of the dosage form for clinical trial, the need for an initial clinical supply is small, as the number of patients for the trial is small and the available drug substance is limited. The optimal dosage form evolves as the clinical study and product research progress. Therefore, it is not necessary to spend much time or resources on dosage form development in the early stages of the trial. If the marketing success in the IND stage of a compound is low, an elaborate design for a dosage form such as tablets may not be wise. Generally, a simple capsule suffices for the purpose. The capsule may be manufactured rapidly with minimal research efforts in preformulation and prepared manually with a hand-filled machine. In addition to the advantage of utilizing minute amounts of available drug substances, the matching of the placebo or camouflage of a referenced product used in a double-blind study

can be accomplished conveniently. Specifications of the clinical supplies must be established, and the QA/QC operation with its stability study per GMP and GCP should be followed.

6. Development and Manufacturing of Dosage Forms

Pharmaceutical dosage forms are a delivery system compounded with the active substance and a number of ingredients to facilitate ease of administration and manufacture. Generally, the dosage forms are solid, liquid, injectable solution, nasal spray, cream, or ointment, collectively referred to as *conventional dosage forms*. In addition to these more traditional forms, recent technological advances, new routes of product administration, and better ways of achieving patient compliance are now accepted by the market. These products include novel drug-delivery systems such as controlled or sustained drug delivery, transdermal patches, nasal delivery, and target site-specific delivery of biotechnology products. Preformulation study as a source of information for product dosage development is a key element of product success.

7. Establishment of a QA/QC System

To establish quality assurance, control of dosage forms, starting from clinical trial to production for market introduction, must be imposed on in-process operations and product testing for compliance with the specifications and guidelines of quality operation to ensure product attributes. Occasionally, specifications may be revised because of new evidence discovered in the continuous preformulation study.

The first step in the product development process is establishing specifications after exploratory research to bring a product to market. Specifications are the quality definition of an article (dosage forms or the related materials for production) upon which acceptance for eventual market distribution is based. The data for establishing pharmaceutical product specifications for both drug substances and dosage forms are defined by identity, purity, strength, and quality, derived from the preformulation study.

8. Preparation of a New Drug Application

The NDA is basically the manufacturer's request to the FDA to market a new drug in the United States. As an agreement between the FDA and the manufacturer, the NDA relates the firm's commitment to manufacturing, quality standards, and drug development activities. Some information included in the NDA may have been submitted earlier in the IND with additional and revised information in the NDA submission. Data and information included are CMC, nonclinical pharmacology and toxicology, human pharmacokinetics and bioavailability, microbiology (for anti-infective drugs only), clinical and statistical sections, case report forms and tabulations, and samples and labeling.

9. Abbreviated New Drug Application

The ANDA is required to market a generic drug product. It is the application for duplicating a drug product that the FDA has previously approved. The submission requires CMC data. A portion of that information may be derived

from preformulation, without data from expensive clinical trials. Evidence of human bioavailability must be demonstrated. In some cases, this requirement may be waived and replaced by a dissolution study.

II. PREFORMULATION STUDIES

Preformulation is the study of the chemical and physical properties of the drug components prior to the compounding process of the formulation. The purpose of the study is to understand the nature and characteristics of each component and to optimize conditions of the dosage form manufacture.

Before formulation development, preformulation data must be generated to aid the development process and the physicochemical properties must be defined. The interaction between the drug components and the excipient used in the formulation are generally included in the study, resulting in intelligent selection of the excipients. The preliminary drug degradation profiles are included in the study to guide the formulation of a stable product. Also included are the analytical characteristics of the component (analytical profiles). A study of this subject aids the development of the monitoring process during the course of formulation development.

IND and NDA guidelines issued by the FDA and the International Conference on Harmonization (ICH) recommend preformulation studies. This regulatory preference may be expanded into a comprehensive preformulation program based on scientific knowledge, industrial experience, and quality consideration to provide information for optimal formulation development, improvement, and product extension.

A. Need for a Preformulation Study

Scientific and regulatory justifications for acquiring preformulation data include the following.

1. Establishment of drug specifications intended for toxicologic evaluation and clinical supply preparations
2. Formulation of clinical supplies and establishment of their preliminary specifications
3. Providing scientific data to support dosage form development and evaluation of product efficacy, quality, stability, and bioavailability
4. Evaluation of the stability of early developed dosage forms
5. Fulfillment of the requirement of the CMC section of the IND and subsequent NDA or ANDA

B. Stages of Preformulation Studies

Timely preformulation data availability is critical because it is an essential prerequisite of development. Delayed progress may result if preformulation data are not available on time. For example, before drug release for safety evaluation, the specifications of the test article must be established. Physical properties, such as melting point, ultraviolet spectrum, and thin-layer

chromatography (TLC) (for the active substance and its impurities), from preformulation are essential for the preliminary specification. Initial data may be simple but should support the development cycle schedule.

To meet the requirement for the timely release of preformulation data, separate reports may be published consecutively and distributed occasionally (it is suggested that they be published in three parts at different phases of the development cycle). They can be periodically revised as developments advance. The preformulation is performed in several stages with different development cycles, which are discussed in the following.

1. Preformulation Report, Part 1: Physicochemical Properties and Analytical Testing for Drugs

This level of preformulation should be initiated in the beginning of the development cycle. The data consist of physicochemical properties of the chemical substance and analytical properties useful in the development of analytical methods, the evaluation of material quality, and testing for the acceptance of the formulation developed. In the early stage of development, the synthetic scheme is developed and the material available for preformulation may be limited. Thus the lack of supply quantities may affect the quality of data obtained. As the development cycle is pushed forward and the drug availability improves, data should be updated or refined with the use of more complicated and accurate methods. Part 1 of the preformulation report may be published before the establishment of specifications. The portion of this report consisting of analytical data may be known as an “analytical profile” in some organizations.

2. Preformulation Report, Part 2: Data Supporting the Development of Dosage Forms

Before formulation development, extensive data must be generated to aid the process. In addition, stability, incompatibility, and solid-state characteristics of a drug must be studied to support product development and improvement.

The selection of the appropriate methods for dosage form evaluation may also be considered as part of the preformulation studies. The evaluation of the dosage form is based on testing: pharmaceutical testing (friability, hardness, disintegration, and dissolution, etc.), bioburden testing (microbiology, etc.), and bioavailability studies. Part 2 of the preformulation report includes revised data from the previous report. New investigations should be discussed before the initiation of the marketed dosage form development.

3. Preformulation Report, Part 3: Support for Quality Control and Finished Product Manufacturing

Previously published preformulation data, with the addition of updates with advanced techniques, are included in part 3. Revised pharmaceutical data as well as specifications, analytical methods of the interim developed product, and issues regarding difficulty of QA/QC may be included. Part 3 of the preformulation report must be published before the marketed product is finalized in “Biobatch,” a scale-up production of 10% of a manufacturing lot.

C. Preformulation Study for Drugs and Health-Care Products

The guidelines and formats for preformulation study described in this chapter are generally applicable to different health-care products, including conventional drug products, biotechnology-derived products, and dietary supplements. Because of the unique physicochemical nature and physiological activity of the products, modification of the study may sometimes be required to obtain meaningful data for the development of prospective products and/or dosage forms.

In the pharmaceutical industry, various products are manufactured based on the following classifications.

- Regulatory classification, such as prescription drug, generic drug, over-the-counter (OTC) products, biotechnology products, dietary supplements
- Physical classification, such as solids, oral liquids, semisolids, and parenteral products
- Dosage forms classification according to use for human or animal consumption

Pharmaceutical products in the regulatory classification are listed in the sections that follow. Their respective concepts with related preformulation studies are discussed.

1. Ethical, or Prescription, Products

Ethical, or prescription, product manufacturers are innovative product development organizations, based in R&D. Most of the pharmaceutical businesses belong to the category of brand-name product (a specific brand name may be given to a particular product), which generates major revenue for the industry. The prerequisite for market introduction of a brand-name product is the FDA approval of the NDA, a lengthy and expensive process. The manufacturing operation is regulated by the cGMP.

In this chapter, most discussion on the creation of preformulation data focuses on the development of the solid dosage form, as the majority of ethical and generic products are tablets or capsules. The guidelines for the generation of preformulation data for other dosage forms such as oral liquid, cream, ointment, lotion, and parenteral products may be modified based on the tablets or capsules program and according to the physical state of the products and manufacturing process requirements.

2. Generic or Multisource Products

Frequently more than one firm may obtain approval to market the same product, which is known as a “multisource product.” The Waxman–Hatch Act of 1984 allows pharmaceutical products to be manufactured and marketed by firms other than the original innovator, upon ANDA approval. Because the chemical name rather than the brand name of the original product is used, this type of product is generally referred to as “generic.” A generic product must have the same active ingredient and route of administration as the innovative product. Although no clinical trials are required, bioequivalency of the generic

product to the innovative product must be exhibited and documented in the ANDA.

The generic product introduction permits competition among some drug products in the market, resulting in a lower cost with minimum quality compromise. Generic products including human or animal drugs may be manufactured by a generic house or an innovative product manufacturer such as a major ethical pharmaceutical house. Many health-care providers, state purchasing agencies, and insurance companies prefer generic drugs for patient prescriptions because of the low price. The prerequisite for the market introduction of the generic product is the approval of the ANDA with manufacturing in compliance with cGMP.

The preformulation study tasks for the generic products are simpler than those for the original prescription products. By the time the generic product is marketed, the innovative drug product may have been sold for a long time. Most of the preformulation data and information have been published and can be found in publications such as the *Analytical Profile for Drug Substances and Excipients*¹⁰ and in the *United States Pharmacopeia (USP)*¹¹ and foreign pharmacopoeia.¹²

3. Biotechnology Products

Biotechnology products are pharmaceutical products prepared by industrial processes that involve the use of biological systems such as fermentation or tissue culture. For some industries, these processes involve the use of genetically engineered organisms. The preparation of products generally involves recombinant DNA, monoclonal antibody/hybridoma, continuous cell lines, and cellular therapy technology.

The biotechnology-derived drug substances are primarily protein or peptide or long-chain molecules (with the exception of short-chain peptides), which may be subjected to degradation by hydrolysis or other denaturation mechanisms. Thus, stability is a serious concern in process handling, formulation, and storage of these materials. Knowledge of pharmacologic properties and toxicity and clinical experience with the isolated protein or peptide may be available to a certain extent.

For biological licensing, two different processes may bring the biotechnological product into the market upon FDA approval. For certain well-characterized biotechnology and synthetic biology products, a biological license application (BLA) is required to gain approval for market distribution. Four categories are defined for this process:

- Therapeutic DNA plasmid product
- Therapeutic synthetic peptide of 40 or fewer amino acids
- Monoclonal antibody products for in vivo use
- Therapeutic recombinant DNA-derived products

For all other biological products, sponsors must submit two applications, an establishment license application (ELA) and a product license application (PLA). Both submission processes (BLA or ELA/PLA) may require nonclinical and clinical data, chemical and biological information, and information on the product manufacturing process and facility. Ultimately, the single-application

BLA system may be the future marketing approval model for submission of all biotechnology-derived products.

Biotechnology products may be different in many respects from the conventional dosage form. A biotechnology-derived drug exists mostly in liquid form, such as proteinlike material with a longer molecular chain that is lyophilic in nature. It may not be heated, because this can cause denaturization of the protein in a short time. The biotechnology dosage forms may be in liquid, parenteral, or special drug-delivery systems, whereas the conventional drug may be primarily in solid form with acceptable solubility and stability.

Modification of the preformulation format for biotechnological products from the original guidance must be considered. The sections regarding chemical structure, physicochemical properties, and stability may be revised according to the nature and characteristics of proteins and peptides. Aside from the conventional analytical instruments and techniques used in the study of small molecules, methods such as amino acid analysis, sequence analysis bioassay, immunoassay, and enzymatic assay are commonly used and should be included in the report.

4. Over-the-Counter Products

OTC, or nonprescription, products are self-treatment medications available without a physician's prescription. These products are intended to treat symptoms of minor discomfort, illness, or injury. Examples of OTC products are analgesic tablets, first-aid preparations, cough suppressants, antifungal agents, and antiperspirants.

Generally, no preformulation study is required, as the formulations of most OTC products are the extension of the marketed product with a change in the content of the active substance only.

5. Dietary Supplement Products

A dietary supplement product is a dosage form containing dietary ingredients such as vitamins, minerals, herbs, and amino acids, as well as substances such as enzymes, organ tissues, metabolites, extracts, or concentrates. After the enactment of the Dietary Supplements Education and Health Act (DSEHA) of 1996, dietary supplements, especially herbal products, have gained much popularity with consumers. Herbal products (also known as botanicals, nutraceuticals, or phytochemicals) occur in nature. Traditionally, little information about the ingredient contents, chemical structures, pharmacologic and toxicologic data, and clinical indications of these products is scientifically documented.

Herbal crude materials are heterogeneous and are available as dried materials, powder extracts, or liquid concentrates. According to the DSEHA, manufacture or distribution of dietary supplements does not require FDA registration or approval before hand. However, the product must be identified on the label as a "dietary supplement," and the label contents must follow an FDA format.

The unique or peculiar aspect of herbal materials that is different from conventional pharmaceuticals is in the definition. The crude drug material or

preparation is considered to be composed of active constituents. Thus, the efficacy of a botanical drug is assumed to be possessed by the entire contents of the crude materials or the preparation. A single component isolated from the crude materials alone cannot be regarded as the drug that generates pharmacologic and clinical responses. In summary, the pharmacologic or clinical response to the herbal drug is activated by the entire contents, either in crude form (herbal ingredient) or in dosage form (herbal preparation).

Ingredients of dietary supplements are chemical components with characteristics and properties similar to those of synthetic drugs. The preformulation study should have the same format as studies of conventional pharmaceuticals. Format modification of some herbal products may be revised according to the unique role and distinct characteristics of herbs.

6. Animal Health Products

Animal health or veterinary drug products are the materials intended for animals other than humans, including drugs used in animal feeds. These drugs may be the same as the human drug approved through the NDA, but approval of a new animal drugs application (NADA) is required for marketing. Additional requirements for “animals for food” include environmental impacts, human toxicology, and residue levels in meat for food consumption. Because most dosage forms for animals are similar to those for the human product, the preformulation study should be the same or should be modified slightly if problems such as mixing homogeneity or instability of “premix” occur.

7. Special or Novel Drug-Delivery Systems

Special or novel drug-delivery systems (DDS) refer to the dosage forms prepared with new drug manufacturing technology (excluding conventional products such as tablets, capsules, cream, ointments, injectables, and suppositories). The business advantages of marketing these products are the convenience of patients, circumventing the drug delivery difficulties of conventional products, and line extensions, particularly for the generic competition. These novel product types may be summarized as follows:

a. Built-in Predetermined Schedule, Convenience of Administration, and Compliance by the Patient

i. Oral Dosage Forms. Sustained- or controlled-release tablets or capsules are dosage forms in this category. In addition to convenience, which increases patient compliance, the advantage of the sustained dosage forms is to provide a smooth blood level in absorption over a relatively long period. The product also avoids the peak-and-valley blood level effect that occurs with single-dose tablets administered several times a day.

Most of the oral sustained-release products are diffusional layer tablets coated with an insoluble polymer, such as a tablet with a biodegradable matrix or an osmotic controlled tablet. The mechanism involves the drug dissolved within the semipermeable polymeric coating. After water absorption, the tablet matrix generates an osmotic pressure, which drives the drug solution out through a tiny hole in the coated tablet.

ii. **Transdermal Systems.** Nonoral products developed for the similar purpose of prolonged delivery without frequent oral administration are transdermal patches such as those containing contraceptives, nicotinamide, nitroglycerine, theophylline, or and dramamine.

b. Novel Routes of Administration That Avoid The Destruction of the Drug Molecule in the Body Before Arrival at the Therapeutic Site

Dosage forms with different mechanisms may bypass the organ of absorption, such as the GI tract. These include, for example, the transdermal testosterone patch. Also capable of bypass is the metered dose inhaler for pulmonary delivery of biological products such as a peptide or protein, with a propellant for lung absorption.

c. Increased Convenience and Patient Compliance for Fast-Dissolving Oral Drug Without Water

Development of fast-dissolving tablets for older patients, pediatric patients, or those with physical difficulties is considered to be a project for a new dosage form by the FDA; thus NDA is required. Technologies used to make these products include tablet molding, freeze-drying, spray-drying, and sublimation. Manufacturing processes that add disintegrant and sugar-based excipients can be problematic. Because fast dissolution of a drug molecule may relate to the high-energy powder in amorphous or crystalline forms, special attention must be given to physical stability in addition to chemical stability.

Preformulation for special or novel drug-delivery systems is basically similar to that of the conventional dosage forms. However, there are some items that may be characteristic of the drug delivery system, such as the drug solubility of a propellant cosolvent mixture, the excipients' compatibility with the specific drug delivery system, and stability requirements that are different from those of conventional products. These items deserve additional consideration.

8. Other Health-Care Products

Other products related to the pharmaceutical business include diagnostic products, medical devices, and radiopharmaceuticals. Although they should have preformulation studies developed on an individual basis, they will not be discussed in this chapter.

D. Preformulation Report

The contents and definition of preformulation studies included are generally broader than those found in published articles or conventional textbooks. The intent is to include articles to assist the formulator in developing an optimal and ideal dosage form either for marketing or for subsequent reformulation. Thus, the following considerations should be included in a comprehensive preformulation report.

1. Analytical Profiles (Required for Analytical Method Development)

Analytical profiles of a new drug must be developed in the early stages of drug development, immediately after the candidate substance is selected. Data

are required to create analytical methods for establishing drug purity, quality control release, and preliminary stability evaluation. Structure evaluation in practice has been completed before candidate identification. Interpretation of structure and the methods used may be included in the analytical profiles.

a. Identification of Drug Substance

Identification of a drug substance is the fingerprinting of a drug material. This ensures that the correct material is utilized for biological testing, pharmaceutical investigation, and production. Infrared spectroscopy (with KBr pellet or Nujol mull) is commonly used for this purpose. UV spectroscopy with the material tested in aqueous or alcoholic solution is a convenient method of identification.

Near-infrared (NIR) has gained popularity for identification, as it is a nondestructive technique. Detection may be made by simply sending a reflective beam by fiber optics into the sample. TLC may be the most convenient and least expensive method for such identification testing. It requires basic equipment, reagent, and techniques and is ideal for use in the field or the cost-constrained laboratory. High-pressure liquid chromatography (HPLC) is used extensively in the laboratory for quantitation of drugs and related components. Identification of a drug component can simultaneously be determined by retention times in the chromatogram. Similar data can also be obtained with gas chromatography.

Another simple identification determination of a drug substance is the melting point. A more sophisticated technique is differential scanning calorimetry (Fig. 1). The melting characteristic may be used for identification and is especially suitable for a polymorphic system. The existence of one or more polymorph forms can be identified. For the identification of hydrates or solvates, thermal gravimetric analysis (TGA) is used (Fig. 2).

For identification of chiral components, optical rotatory dispersion (ORD) or circular dichroism (CD) techniques may be used. With the appropriate column, HPLC may be used most effectively for chiral compound identification.

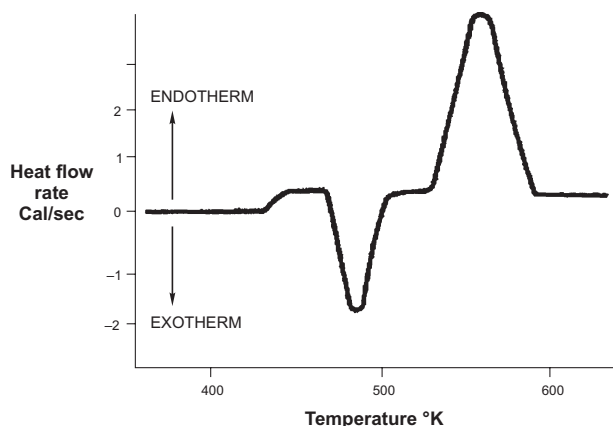

FIGURE 1 Differential scanning calorimetry thermogram.

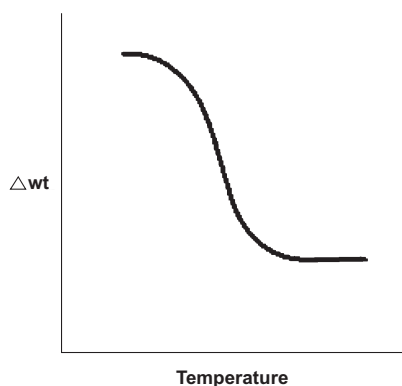

FIGURE 2 Curve of thermogravimetric analysis.

b. Purity, Degradation Products, and Retained Solvent

Purity is the measurement of the quantity of a prevalent component of a drug substance when only that component is present. The purest material is generally regarded as a reference standard and is used to determine the purity of a drug by a comparative UV spectroscopic method. However, the precision of the UV method may not be high in some cases. Furthermore, the absolute purity of a reference material may be impractical to measure; thus, UV for purity determination may have its limitations.

Titration methods such as acid–base, oxidative, or precipitate are conventionally used per the USP for the determination of strength, potency, or purity of drug substance. Potentiometric methods using automatic titrators for nonaqueous titration are commonly used in the quality control laboratory. Most drug substances are the salts of an organic base such as the hydrochloride salts, which can be titrated with perchloric acid in a nonaqueous solvent, for example, acetic acid with the addition of perchloric acetate. Titration adapted as a purity measurement for a drug substance is limited, as it may titrate only one functional group such as an acid or a base. However, other extraneous material in a sample with a titratable functional group will interfere with the assay and give an erroneous result.

Another approach to measuring purity is to determine impurities quantitatively after resolution by chromatography. The idea is to look at the impurities as a reflection of purity (i.e., a substance is considered pure when no impurity is found). Because the detection of a minute amount of substance impurity is precise, the sensitivity of determination is generally high. Thus, minute amounts of impurities can be detected. The presence of impurities can best be detected by TLC, CE, HPLC, or GLC.

Qualitatively, purity may be detected by melting and cooling. The melting range determination of the USP is a simple yet excellent tool for comparing the purity of the same solid materials. The purer the substance, the narrower the melting range. Thus the substances with lower purity yield wider melting ranges.

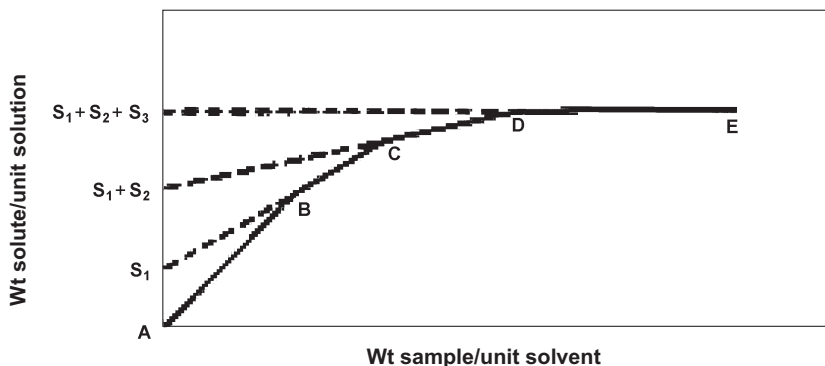

FIGURE 3 Phase-solubility diagram of a three-component mixture.

c. Absolute Purity

In most cases, the purity of a pharmaceutical substance is determined by comparison of the reference standard with the known purity assigned. On the other hand, when no reference standard sample is available, the purity is determined by an absolute method in which the calculated result is based on theory and not by a comparative method. Purity established by analytical methods such as phase-solubility analysis¹³ or differential scanning calorimetry (DSC)¹⁴ is known as absolute purity (Figs. 3 and 4).

2. Chemical Properties

Chemical structure is established earlier in the discovery stages, immediately after the substance is synthesized, to ensure substance integrity. The properties determined include chemical structure, molecular weight, and empirical formula.

Elemental analysis (C, H, N, O, and Cl) verifies the empirical formula; thus the molecular weight is first obtained, followed by elucidation of the

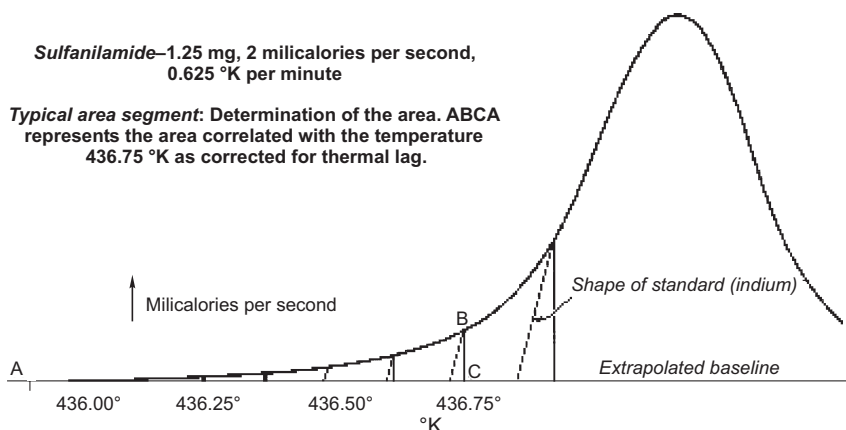

FIGURE 4 Purity determination by DSC.

structure by spectroscopic techniques. The methods commonly employed for structure assignment are nuclear magnetic resonance (NMR) and mass spectrometry (MS). Conventional methods such as infrared (IR) spectroscopy and methods for the characterization of chiral property such as ORD or CD are also used.

The data for structure elucidation should be included in the preformulation reports, and the interpretation and conclusions may be reported in the same manner as those published in the *Analytical Profiles of Drug Substance and Excipients*.

3. Thermodynamic and Physicochemical Properties

a. Dissociation Constant, pK_a

In the development of liquid formulations, such as dosages for early stages of animal pharmacologic studies, improving solubility is a key task for the formulator because most drug substances are not soluble in water. For ionizable substances such as acids or bases, the solubility at a given pH may be estimated if the pK_a is known. On the other hand, the solubility of a nonionizable substance is not affected by pH. The increase in solubility depends on the co-solvent system or solubilization agent.

According to the Henderson–Hasselbalch equation,

$$pK_a = \text{pH} - \log(A^-/\text{HA})$$

where A^- is the ionized species and HA is the protonated species.

The methods of determination are based on the above equation. When A^- equals HA, that is, $(A^-/\text{HA}) = 1$, the last term of the equation drops out. Thus, the pK_a of the drug of interest is the pH value at that ionic concentration ratio.

Common methods of determination of pK_a based on the Henderson–Hasselbalch equation are

- UV spectrometry determination
- Titration determination
- Solubility determination

b. Solubility

Solubility is the concentration of a substance in a saturated solution at a given temperature and relates to thermodynamic properties such as entropy or fugacity of the drug molecule. In the concept of drug adsorption, the delivery of a drug molecule into the systemic circulation requires initial transport through the GI membrane. The mechanism of action is governed by the dissolution and the intestinal permeability of the drug molecule. The driving force of dissolution is the aqueous solubility of its molecule: the higher the solubility (higher hydrophilicity), the faster the rate of dissolution. The subsequent penetration of the lipid membrane depends on the lipophilicity of the drug molecule, which may be correlated with the partition coefficient value. Efficient absorption depends on the proper balance between these two opposite properties.

The study of solubility characteristics is generally carried out in the early stages, as it affects the dosage design, especially in tablets or capsules. It has been suggested that a solubility of less than 1% (10 mg/ml) over a pH range of 1 to 7 at 37°C may result in absorption problems. Poor bioavailability of a dosage form design can be indicated by a simple solubility determination. Conversion of the substance, as in the formation of a salt, may avert the problem. Furthermore, the supply of the new drug substance is limited in the early development stage. Solubility determination does not present a problem and requires a minimum of material.

c. Method of Solubility Determination

Solubility is typically determined by placing an excess amount of solute into a screw-capped test tube of proper size. An appropriate quantity of solvent is added, and the tube is capped securely. Tubes are placed in a bath kept within 0.5°C of the desired temperature. Sample tubes are rotated end over end mechanically until equilibrium is reached.

Periodic samples are taken for analysis to ensure stability and the attainment of equilibrium. Caution must be taken to prevent leakage. After equilibration, the sample is allowed to stand for settling of the excess solids. The solution is carefully withdrawn, filtered, and diluted accordingly. The solution may be analyzed gravimetrically or with suitable analytical methods such as UV or HPLC.

Solubility may be determined according to the function of the study as follows.

i. Solubility as a Function of Temperature. Solubility may be determined at several temperatures and plotted against the reciprocal of the absolute temperature (temperature in °C + 273), resulting in a straight line. This plot is based on the van't Hoff equation,

$$\ln X_2/X_1 = \Delta H^\circ/R(T_2 - T_1/T_1T_2)$$

where X_1 is the solubility at temperature T_1 , X_2 is the solubility at temperature T_2 , ΔH° is the standard heat of reaction, and R is the gas constant. From the van't Hoff equation, the solubility at a given temperature can be estimated.

ii. Aqueous Solubility with Varying Buffered pH Values. Solubility may be determined in various pH values with buffer solutions at constant temperature. For convenience of analysis, buffer systems without UV chromophores are desirable. The solubilities may be determined by UV spectroscopy after proper dilution or by HPLC. Plotting pH versus its related solubility according to the Henderson–Hasselbalch equation includes

$$\text{pH} = \text{p}K_a + \log(\text{B}/\text{BH}^+) \quad \text{for base}$$

$$\text{pH} = \text{p}K_a + \log(\text{A}^-/\text{HA}) \quad \text{for acid}$$

Thus, $\text{p}K_a$ may be obtained, and solubility at a given pH may also be calculated (Fig. 5).

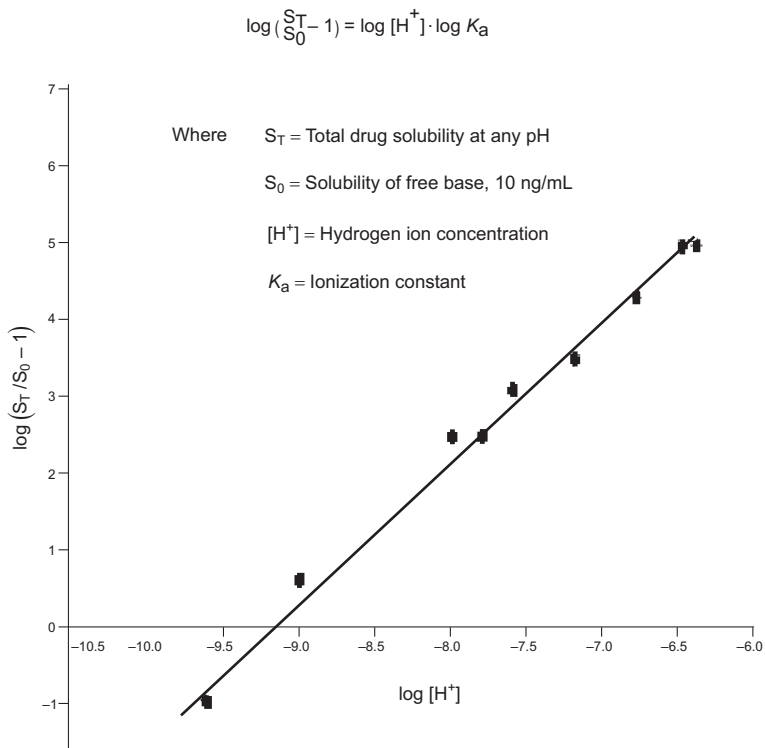

FIGURE 5 Determination of pK_a by solubility.

iii. **Solubility in Organic Solvents.** Solvents such as alcohols, acetonitrile, tetrahydrofuran, and chlorinate solvents are commonly used for drug formulation or analytical determination. Solubility in organic solvents is useful for the development of chromatographic methods or co-solvent systems for less soluble drugs. Determination may be made gravimetrically after evaporation under an IR lamp, or with HPLC.

d. Solubilization

Solubilization is the increase in solubility of a poorly water-soluble substance with surface-active agents. The mechanism involves entrapment (adsorbed or dissolved) of molecules in micelles and the tendency of surfactants to form colloidal aggregations at critical micelle concentration levels. Thus, the critical micelle concentration is the minimum surfactant concentration that begins solubilization of the insoluble molecule. Increases in the concentration of micelles lead to increases in drug solubility.

Some commonly used surfactants approved for use by the FDA for parenteral products are polysorbate 20, 40, and 80; sodium deoxycholate; monopalmitate; and polyoxyethylated substances of fatty acid, castor oil, and sorbitan.

For liquid dosage forms of water-insoluble drugs, solubilization is an important tool in preformulation studies for the selection of surfactants. When

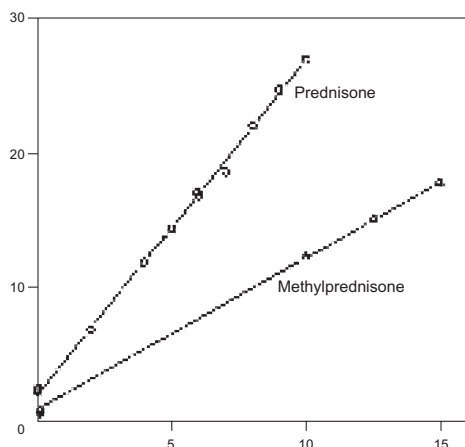

FIGURE 6 Apparent solubilities of some anti-inflammatory steroids as a function of surfactant concentrations.

apparent solubility is plotted as a function of surfactant concentrations, a straight line may result (Fig. 6). The selection of a surfactant may be based on this type of plot with different surfactants.

Other considerations in the selection of surfactants that must be included are toxicity, stability, physiological effects (permeability in the GI tract), and the influences on other pharmaceutical adjuvants such as antioxidants and coloring agents.

4. Pharmaceutical and Mechanical Properties

a. Hygroscopicity and Moisture Absorption/Desorption

Hygroscopicity is the ability of solids to adsorb water onto their surfaces microscopically. The rate of adsorption and the equilibrium amount of water adsorbed depend on the relative humidity of the atmosphere. For solid substances, it is important to learn if the material under study is hygroscopic. Thus, steps into drying and storage, such as humidity control in the production and packaging environments, may have to be established to avoid manufacturing difficulties and instability problems.

Adsorption and desorption isotherms may be determined by monitoring equilibrium moisture uptake or loss in samples stored in desiccators with different relative humidities (saturated salt solution yielding different percentage relative humidity). The amount of water present is determined by loss of drying (LOD), TGA, Karl Fischer titration, the coulometric method, or near-IR spectroscopy.

A relatively fast and less labor-intensive process is the dynamic vapor sorption method. In this automated process, the sample is placed on a microbalance within the environment of a given relative humidity at a constant temperature. The relative humidity is changed continuously with a device controlled by a computer. The change in sample weight is monitored as a function of time or as a function of relative humidity, and the event is recorded. The weight gained (adsorption) or weight lost (desorption) versus relative humidity may

be recorded. Thus, the adsorption/desorption isotherm is obtained. In the same manner, the kinetics of adsorption/desorption may be obtained by measuring the weight of a sample at constant relative humidity and temperature as a function of time.

In the preformulation study, the comprehension of physicochemical properties regarding water–solid surface interaction is beneficial to the handling, formulation, and manufacture of the finished products. Data on sorption/desorption isotherm, hydration of salts of drug product, water sorption of pharmaceutical excipients, and kinetics of water adsorption or desorption of a substance can be obtained effectively by the dynamic vapor sorption method. The knowledge may be utilized for dosage form design and supports the understanding of the mechanism of action.

b. Powder Characteristics

Solid dosage forms such as tablets or some capsules (plug formation in automatic capsule filling) are a compaction of the individual mass of active substances and excipients such as fillers, disintegrants, gliders, and lubricants. The physical interaction of these materials contributes to the making of an acceptable process and a good product. Understanding the powder characteristics of the drug will be helpful in developing the formulation process. The methods of establishing these characteristics are as follows.

i. Bulk Density. Bulk density is the volume of powder per gram of weight in a cylinder, after 50 mechanical taps.¹⁵ Tap density is measured in a tapping machine containing a graduated cylinder that moves up and down. Powdered material is introduced into the cylinder. The tapping begins. The mark of the graduated cylinder is noted before tapping (V_0) and after 2, 4, 6, 8, 10, 15, 20, 30, and 50 taps (V_{50}). The column height as indicated by the mark in the graduated cylinder is related to the volume measured, and the diameter of the volume is fixed. Volume may be calculated accordingly. The powder content (W) is weighed, and the bulk density is calculated as W/V_{50} g/ml. Bulk density may be used as an indication of flow properties. The ratio of tapped density W/V_{50} to fluffy density (W/V_0 g/ml) is known as the Hausner ratio. A good flow is indicated by a Hausner ratio greater than 1.25, and a poor flow may have a value of 1.5.

ii. Angle of Repose. The angle of repose (Fig. 7) is a parameter commonly used for the evaluation of interparticle force.¹⁶ The simplest method for the

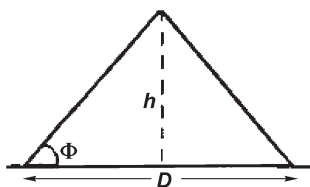

FIGURE 7 Angle of repose.

determination of the angle of repose is the “poured” angle. A funnel with a wide outlet is affixed at a distance of 10 cm above the bench, where a piece of paper is placed directly beneath the funnel. Powder is added while the funnel is closed. The contents flow through and collect on the paper. The diameter of the cone (D) and two opposite sides ($l_1 + l_2$) are measured with rulers. The angle of repose (θ) is calculated from the equation $\arccos[D/(l_1 + l_2)]$. The relationship between flow properties and angle of repose has been established. When the angle of repose is less than 25 degrees, the flow is said to be excellent; on the other hand, if the angle of repose is more than 40 degrees, the flow is considered to be poor.

iii. Compression Properties. Most drug substances cannot be compressed alone and frequently require compression aids such as microcrystalline cellulose to form a tablet. Direct compression is the current method of choice for tablet manufacturing. Generally, a tablet containing less than 50 mg of the active substance can be prepared by the direct compression method. Higher amounts of drug content in a tablet require manufacture by the wet granulation method.

Essential information from the preformulation study must be obtained on the compressibility of the drug substance alone. The correct selection of compression aid, either fragment (e.g., lactose or calcium phosphate) or plastic (e.g., microcrystalline cellulose), depends on the compression characteristics of the drug substance. Such characteristics can be evaluated in terms of elasticity, plasticity, fragmentation, and punch filming by mixing a drug substance of interest with 1% magnesium stearate.¹⁷ Three samples are prepared as A, B, and C. Samples A and B are combined by tumble mixing for 5 min, and C is tumble mixed for 30 min. The samples are then compressed with different conditions specified. After overnight storage, the compact crushing strength of each sample is determined. The interpretation of the drug substance as plastic or fragmented depends on the relative values of samples A, B, and C. For example, if the crushing strengths of the three samples are equal to each other, the material may be considered to be fragmented. On the other hand, the material may be said to be plastic if the crushing strengths are found to be $C > B > A$.

The relationship of punch force and compaction pressures (measured with compaction equipment) to preformulation characteristics such as compactibility, dissolution rate, content uniformity, tensile strength, and disintegration time has been reported.¹⁸

c. Mixing and Blend Uniformity

Mixing or blending is a critical process in the manufacture of dosage forms, especially in the production of tablets and capsules. The tablets or capsules prepared from the blend of poor mixing with active ingredients and excipients may fail the quality control test for content uniformity of the dosage forms. The acceptance limit according to the USP is based on the calculation of an individual assay of 10 tablets with a relative standard deviation equal to or less than 6%.¹⁹ Failure to meet the criteria results in rejection of the production lot.

As a result of a court ruling on generic manufacturing (*USA versus Barr Laboratories*),²⁰ a blend uniformity test has been proposed as a regulatory requirement for the in-process control of the manufacturing for some solid dosage forms. The acceptance limit of blend uniformity for the powder mix currently is the same as that of the content uniformity for the finished product. The idea behind the court's decision is that the in-process control in blend uniformity will give additional assurance that a batch of product will meet the content uniformity test if the blend mix is homogeneous. Difficulty in the study of blend uniformity arises when different types of sampling device are used.

The proper selection of sampling techniques or sampling devices affects the calculation value of the relative standard deviation of a powder mixture, the indication of homogeneity. With the use of conventional side slit thief for sampling for blend uniformity analysis, discrepancy between the two values (blend uniformity versus content uniformity) can be determined. In the manufacture of some tablets, the relative standard deviation of the blend uniformity of a lot of bulk powder mix was found to be unacceptable and should have been rejected, whereas the tablets prepared with that powder blend unexpectedly met the content uniformity test. The noncorrelated relative standard deviation values of these two tests required clarification.

A specially constructed unit-dose compacting thief (Fig. 8) was later used for the blend uniformity analysis of the powder blend. The result showed that the blend uniformity analysis correlated well with the content uniformity test of the tablets. This patented sampling device is so constructed that a preset volume of powder or granulate can be withdrawn from the bulk and subsequently compressed in situ mechanically into a compacted plug. The device is front loading in design to avoid particle segregation and is capable of forming compressed cake with a consistent volume (adjustable for desirable size). Thus, quantitative, precise, and reproducible volumetric samples of bulk powder or granulates may be obtained. In the blend uniformity analysis, several devices or techniques are available for sampling: cone and quartering, scoop sampling, chute sampling, spinning riffler, near-IR optical fiber spectroscopy,

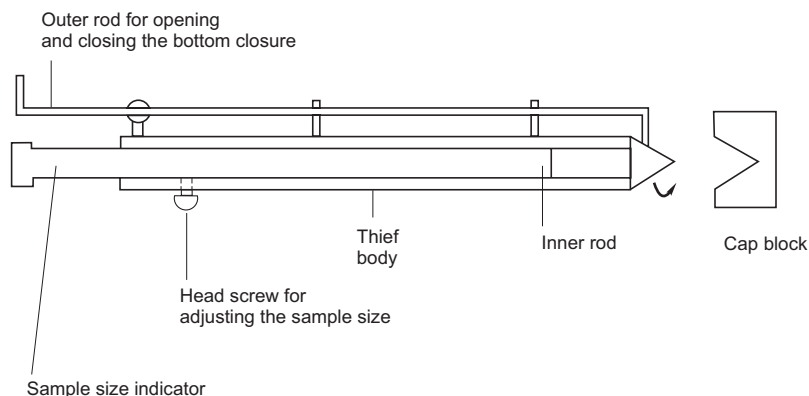

FIGURE 8 Schematic diagram for the unit-dose compacting thief.

and sampling thief. The suitability of these devices/methods should be evaluated and established in the preformulation stage, before the acceptance for process validation and in-process control testing for a new product.

5. Solid-State Characteristics

A solid drug substance may have different internal physical arrangements and exist as different forms (see Chapter 3). Because of the change in thermodynamic force, the metastable solid (most energetic state) may convert into the stable form (least energetic state). The metastable solid is believed to have the greater physiological activity because it has higher fugacity (or escaping tendency), resulting in higher solubility and thus, faster dissolution. The metastable solid may be the material of choice based on the assumption of its bioavailability. However, this metastable material is in the high-energy state and will eventually convert back to the stable state. Furthermore, the conversion may follow a kinetic rate of change but will rapidly and unpredictably change to a stable form once the nucleus of the stable form exists. The discovery of a process for arresting the nucleation of the stable form is a formidable challenge. This will be necessary before metastable crystals can be used.

In solid dosage forms, including tablets, capsules, and powders, the modification of the physical properties of the active drug substance may greatly affect its physiological performance. Thus, thermodynamic changes in the crystalline structures of a given drug can affect the physical properties of a solid drug. This crystalline modified material may have a different solubility, dissolution rate, and physical stability, resulting in an enhanced therapeutic value.

a. Polymorphism

Polymorphism is defined as the existence of a chemical molecule in different crystal forms or crystal packing arrangements. There is evidence to support the claim that most organic compounds are polymorphic. The existence of two polymorphic forms is also prevalent, and three or more polymorphic forms are not uncommon. Different polymorphs have different physical properties, such as melting point, solubility, density, hardness, and crystal shape. Because of the difference in solubility, a difference in dissolution rates of the polymorphs is expected. Bioavailability in animals or humans may be different, therefore, among the polymorphic forms. This potential difference is an important consideration in pharmaceutical dosage form development.

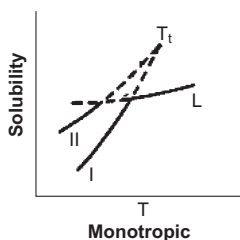

FIGURE 9 Solubilities of two polymorphs in a monotropic system.

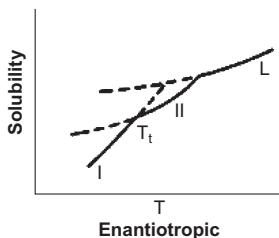

FIGURE 10 Solubilities of two polymorphs in an enantiotropic system.

Polymorphism can be detected by the differences in physical properties due to individual characteristics. Based on the fugacity, which relates to the thermodynamic term, entropy of the solid molecule, polymorphism may be defined as monotropic or enantiotropic. Furthermore, combination of these two systems, monotropic and enantiotropic, may yield a third system. The definition of these categories may best be illustrated by the solubility–temperature plots, based on the van’t Hoff equation. In a monotropic category as shown in Figure 9, the solubility of form I (the stable form) and that of form II (the metastable form) will not intersect each other at the transition temperature calculated only from the extrapolation of the two curves. In the enantiotropic category (Fig. 10), the solubility of form I (the stable form) and that of form II (the metastable form) will intersect each other at the transition temperature. In the combined category (Fig. 11), for which there are two transition temperatures, the solubility of form III will not intersect any other curves.

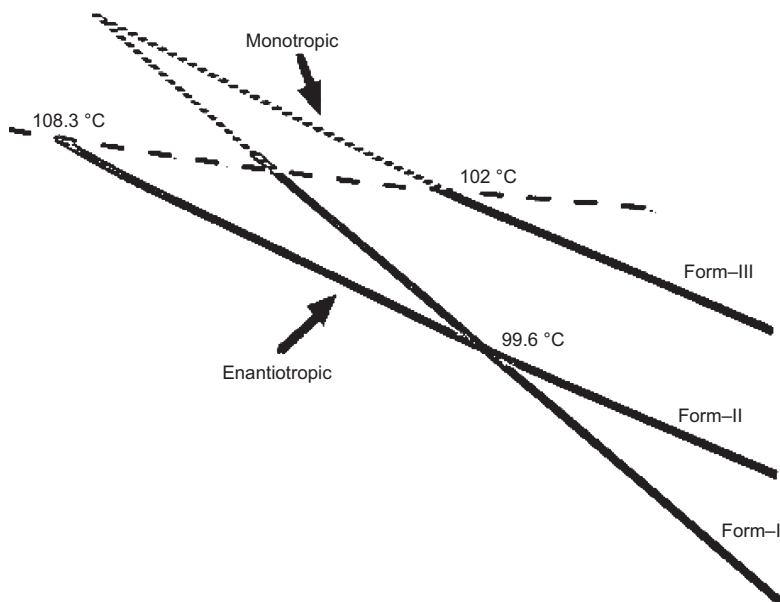

FIGURE 11 Melting point /temperature K curves for an enantiotropic and monotropic combined system.

i. Preparation of Polymorphs. Different polymorphic forms may be prepared by using different conditions such as solvents of crystallization, cooling rate in crystallization, cooling of the melt, freeze-drying, and seeding.

ii. Polymorphic Transition. Thermodynamically, conversion from the higher-energy crystal metastable form (referred to as β or form II) to the lower-energy crystal stable form (referred to as α or form I) is possible. The transition temperature is the temperature at which the two polymorphic forms are in equilibrium. As discussed, the two types of polymorphic transitions are monotropic and enantiotropic. Whereas the transition temperature may be found from the van't Hoff plot for the enantiotropic system, the transition temperature of the monotropic system may be established by extrapolation of the solubility curves.

iii. Methods of Study of Polymorphism. Based on the difference in physical properties, polymorphism has been studied using instruments or techniques described in the following sections.

A. Solubility. The simplicity of the method and the convenience of conducting the study make solubility (Figs. 12 and 13) the best method for the study of polymorphism, providing that there is no metastable conversion taking place during equilibrium. Care must be taken to ensure the absence of the transition of the metastable form. Frequent withdrawal of samples to test the solubility in reaching the plateau is one way to ensure that transition has not occurred. Replacement of the solvent with another suitable choice should be considered if conversion is observed. According to the van't Hoff equation, the plot of log solubility versus $1/\text{temperature in K}$ should be a straight line. In the study of methylprednisolone,²¹ an enantiotropic system with form I (stable form) and form II (metastable form), two straight lines crossing each other at a point are found in the van't Hoff plot, as shown in Figure 12. The intersection is the transition temperature; the lower line below the transition temperature is the stable form; and the upper line is the metastable form below the transition temperature. The relationship is independent of the solvent used.

B. Dissolution Rates. Difficulty in polymorphic study arises from the physical instability of the polymorph during the solubility determination. In a solubility determination of a polymorph, less soluble drugs such as steroids, in particular, require longer times to reach equilibrium. The metastable β form converts to the stable α form during that period, resulting in solubility of the α form. An ingenious method using an intrinsic dissolution technique has been developed that overcomes the difficulty of obtaining the solubility of the metastable β form.²²

C. Hot Stage Microscopy. A hot stage microscope, including a temperature-controlled heating stage, is inserted directly under the magnifying lenses of the microscope. Two coverslips with a sample sandwiched between them are placed on the hot stage. Change in temperature is visually observed with a thermometer. Crystalline transformation can be observed with or without

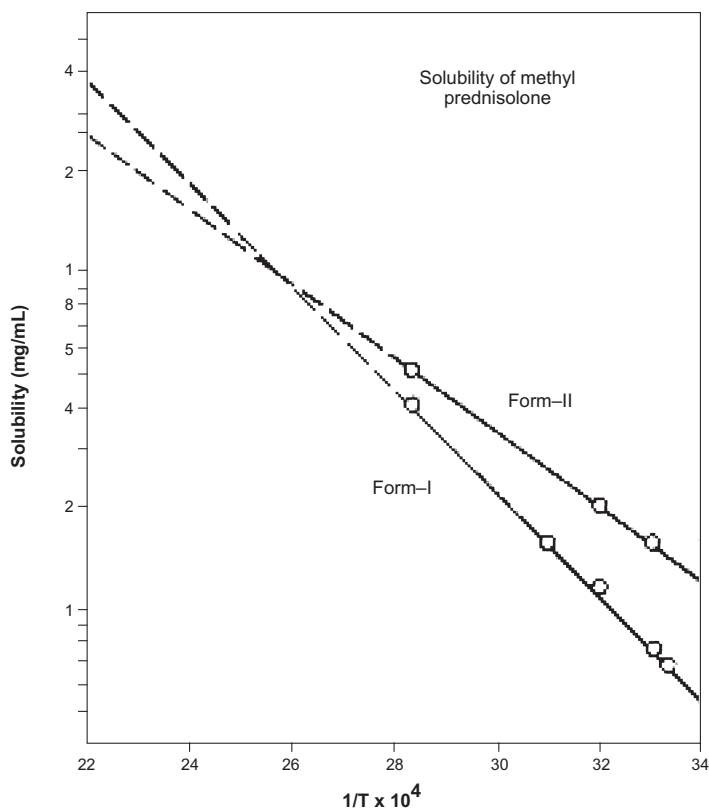

FIGURE 12 Water solubilities of two polymorphic forms of methylprednisolone as a function of temperature.

polarized light, and the change, correlated with the temperature reading, may be recorded. This observation can be performed with a still camera, a TV camera, or other electronic devices. The hot stage microscope is a good complementary tool for DSC. In earlier research, German chemists with hot stage microscopes found many materials to be polymorphic, such as barbitals, sulfonamides, and steroids. The simplicity of the equipment and the use of small amounts of material with existing microscopes enabled them to carry out experiments in a difficult wartime situation with limited scientific resources.

D. Differential Scanning Calorimetry. In the monotropic transition system (Fig. 11), two melting points may be found in the thermogram. The stable α form generally has a higher melting point, and the metastable β form has a lower melting point. The transition temperature, which is higher than both melting points, may not be observed in the thermogram. However, it can be estimated by extrapolation from the van't Hoff solubility curve obtained from the data of the solubility study at several temperatures. There is no interconversion of the two polymorphs in the monotropic system.

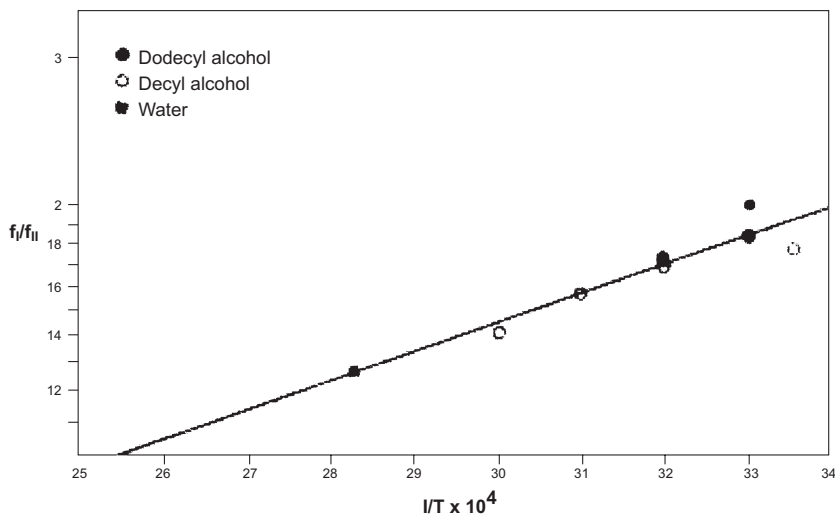

FIGURE 13 Solubility ratio for the two polymorphic forms of methylprednisolone as a function of solvent and temperature.

In the enantiotropic transition (Fig. 11), when the stable α form is heated, only one peak, the melting point, is observed in the thermogram. After cooling (rapid but noncontrolled cooling rate), the same heating curve is obtained.

When a metastable (β) form is heated, the transition temperature appears generally as an exothermic peak (goes from a high-energy level to a low-energy level). This temperature of the exothermic peak shown in the thermogram is lower than the melting points of either stable or metastable forms. On further heating, the melting point of the β form appears in the thermogram higher than that of the α form. To carry the study further, the heating curve of the melt is rescanned and found to be the same as that of the stable form (α form). The melt of the metastable form generally converts back to the stable form. Because there is a transition temperature to be considered, stable or unstable forms must be defined relative to the transition temperature. For this reason, a stable form below its transition temperature becomes a metastable form above its transition temperature.

E. Other Methods. IR or Raman spectroscopy, X-ray diffraction, solid-state NMR, dilatometry, and moisture sorption isotherm may be used as tools for the qualitative or quantitative study of polymorphism. Brief descriptions of these techniques may be found elsewhere in this chapter.

iv. Application of Polymorphism in Pharmaceutical Development. Polymorphs of the metastable forms existing in a higher energy state have a higher solubility than the stable forms and thus better bioavailability. At the outset, a metastable form is a good candidate for dosage form development because it will provide a better bioavailability product. However, the metastable form is not physically stable and will convert gradually, rapidly, or abruptly to the stable form. For a metastable substance, one may argue that the kinetic

conversion rate can be determined and the shelf life established accordingly. Unfortunately, the crystal conversion from the metastable β form to the stable α form may be catalyzed by the seeds of the stable forms. Once the seeds reach a critical cluster, the growth will become rapid and uncontrollable.

In the best case, the product with high bioavailability will not be consistent. In the worst case, the new product changes abruptly or unpredictably into the stable form, resulting in a product with poor performance, particularly in a poorly soluble drug. In some pharmacology studies, dosage forms of a drug prepared with a metastable form yield good absorption data when compared with the stable form.

Nevertheless, this observation cannot be reproduced because of the polymorphic changes that occur when the drug is stored. Until the challenge of controlling or stabilizing the polymorphism conversion is met, the application of polymorphism in pharmaceuticals will be questionable. The knowledge and data on polymorphism are important to the pharmaceutical industry. Many pharmaceutical problems can be explained or avoided if the concept of polymorphism is understood and methods of detection, control, purification, and isolation are available.

b. Hydrates and Solvates (Pseudomorphism)

Hydrates or solvates of a drug substance, similar to polymorphs, are crystal modifications of a drug substance. This characteristic of solvate formation is sometimes known as pseudomorphism. The water of crystallization in hydrates and the organic solvent in solvates are incorporated with the drug molecule to form a unique structure.

The physical properties such as melting behavior and solubility may be varied. Melting behavior can be observed best in the hot stage microscope. In the dissolution study of theophylline, as shown in Figure 14, concentration of the anhydrous form of the drug substance approaches the peak and gradually comes down to the concentration of the solubility of the monohydrate form. Such changes indicate that the anhydrous form may have a higher energy level, but it is a metastable form.²³

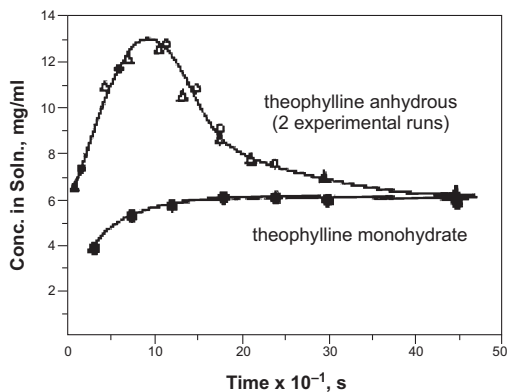

FIGURE 14 Conversion of anhydrous to hydrate-crystal form of theophylline in water.

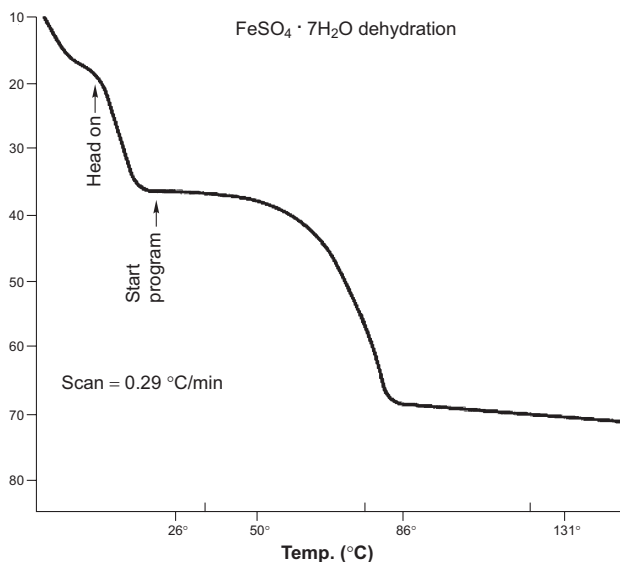

FIGURE 15 TGA for $\text{FeSO}_4 \cdot 7\text{H}_2\text{O}$.

The transformation of the anhydrous sodium warfarin, an amorphous substance, into the solvate, which is crystalline, demonstrates the utilization of technology for some commercial advantages. The amorphous sodium warfarin is crystallized from isopropanol to form a clathrate with a molecular ratio of 2:1. This formation was awarded a patent extension because of the material crystallized out of the solution, resulting in purity improvement.²⁴

Hydrates and solvates can be prepared by crystallization in water or an organic solvent or by conversion of the anhydrous material through moisture or solvent adsorption. In quality control testing, hydrates or solvates are identified by the assay of water of crystallization or solvent found in the crystal. Water determination is achieved by Karl Fischer titration or a coulometric method or loss-on-drying by the USP method. In the preformulation study, the hot stage microscope is a useful simple technique. TGA can also be an informative tool, as shown in Figure 15.

The dynamic moisture adsorption isotherm is another useful tool, exemplified by the water sorption/desorption of DMP 728 zwitterion²⁵ as shown in Figure 16. DSC may not be helpful unless the technique is modified by punching a tiny hole in the pneumatic sample cap, from which the moisture or solvent may escape with a narrow thermal peak. Another method is to place the sample in silicon oil on the sample pan. The thermal effect of solvent boiling out is observed in the thermograph.

c. Amorphous Powders

An amorphous drug substance is a powdered material without crystalline structure. Thus, no X-ray powder diffraction pattern or thermal peaks in the DSC can be observed. Amorphous powder can be prepared by rapid cooling of a solution, coprecipitation with an organic solvent, or freeze-drying or from the melt. Because the entropy of the amorphous powder is high, the solubility

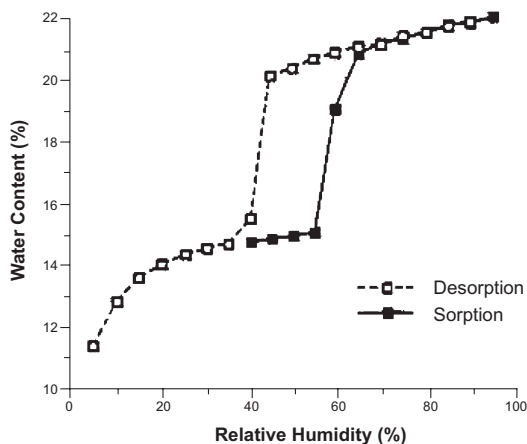

FIGURE 16 Dynamic adsorption/desorption isotherm.

of the amorphous material is the highest among all crystalline forms. One may conclude that the high solubility characteristic is an advantage in the design of a product with high bioavailability. Like a metastable polymorph, the conversion mechanism is not controllable. An amorphous substance may suddenly revert to crystal growth, depending on the nucleation process, resulting in the formation of crystalline materials. Until the technology of retarding nucleation develops, utilization of an amorphous drug for increasing bioavailability is a risky concept. Although products have been manufactured with amorphous material in the injectable form, its validity is debatable.²⁶

In the preformulation study of AG 1284, a human immunodeficiency virus (HIV) protease inhibitor, a concentrated solution of an amorphous form (prepared in various pharmaceutical solvents) exhibits precipitation on standing. The precipitate was identified as a crystalline drug substance with a solubility much lower than that of the amorphous form.²⁷ This phenomenon may be explained by the fact that the solution is considered to be supersaturated based on the equilibrium solubility of the crystalline form. As soon as the homogeneous or heterogeneous nucleation begins (the seed is grown to its critical size or grown on extraneous foreign particles), crystal growth of the stable form will occur. Because the concentration of the drug is higher than the solubility of the crystalline materials, the driving force of the crystal growth is high. Thus, the precipitate is the crystal form, with a solubility much lower than the concentration of the amorphous materials prepared. This observation is a good illustration of the pitfalls of using amorphous substances to formulate some dosage forms intended to increase bioavailability. Because an amorphous material is a high-energy solid, conversion or growth of crystals may occur gradually or spontaneously, resulting in unwanted precipitation in liquid or problems of aggregation in suspension.

d. Morphology, Size, and Surface Area

i. Crystal Morphology. Particle shape or crystal habit can be identified as tabular (cuboid), platy (plates), prismatic (rods), acicular (needle), or bladed

(spatula). Such shapes or habits of crystals may be prepared through the modification of crystallization process parameters, including cooling and stirring rates, the solvent of crystallization, and the addition of a co-solvent or an additive. Conversion of solid forms is possible with heating. It is important to recognize that the different crystal shapes of a material may not necessarily have different physical properties such as melting point, solubility, and dissolution rates. Crystal morphology may be determined by microscope, electron microscope, or image analyzer. A quantitative characterization of solid excipients based on the analysis of individual particles and quantifying particle shape has been published and provides additional information.²⁸

ii. Particle Size Distribution. Particle size and size distribution play an important part in manufacturing processes (such as blending, flow property, and tablet compression) of solid dosage forms (tablet and capsule) as does physical stability in the manufacture of semisolid dosage forms (ointment, cream, and suspension). In solid dosage form with less soluble drugs, particle size is a major consideration for bioavailability.

In the manufacturing environment, particle size distribution of the powder may be determined by the sieving analysis described in the USP.²⁹ In preformulation study and quality control testing, the Coulter counter, an electronic device with a monitoring system, has frequently been used. The operation principle of the instrument is based on the electrical resistance of two electrodes in two separated compartments joined by an orifice with a defined circular area. Each time a particle being measured enters the orifice, the resistance may change proportionately to the size of particle.³⁰ A popular analyzer is the laser light-scattering device. When a particle passes through a laser beam, light scattering occurs in a concentric ring. The diameter of the ring depends on the size of the particle causing the diffraction. The intensity of the ring is in proportion to the number of particles causing the diffraction. The laser particle analyzer is based on this principle.

iii. Total Surface Area. The total surface area of a powder drug is inversely proportional to its particle size; that is, the smaller the particle, the larger the total surface area. Reduction of particle size in a drug substance, especially in the submicron range, may increase the pharmacological activity of a drug. For an insoluble drug, the size reduction to the micron range (micronization) may change the activity from a nonactive component to an active drug substance partly because of the increase in the total surface area.

The total surface area or specific surface area (area/unit weight) is determined by the nitrogen absorption method known as the BET (Brunauer, Emmett, and Teller) absorption isotherm of an inert gas. The principle of this technique is based on the monolayer adsorption of nitrogen at low temperature, which has a fixed spherical volume.³¹ Thus, the amount of nitrogen adsorbed is proportional to the total surface area of the sample.

6. Biopharmaceutical Properties

The therapeutic performance of a pharmaceutical dosage form, particularly oral solid dosage forms, which include the majority of drug products

sold, depends greatly on the biopharmaceutical properties of the drug substance. Biopharmaceutics may be defined as the study of some of the physical and chemical properties of a drug and its dosage forms along with the biological effects observed after administration of the drug in various dosage forms. These properties include solubility, crystal structure, dissolution rate, partition coefficient, and permeability. For oral absorption of a tablet or a capsule, the kinetics of absorption is controlled by two mechanisms: the dissolution of the dosage forms and the permeability of the drug molecule through the GI tract. For a slowly dissolving tablet or capsule, the dissolution rate is the limiting factor in adsorption. When the dissolution is fast, the permeability is the limiting factor in adsorption. Biopharmaceutical properties related to physicochemical nature have been discussed elsewhere in this chapter. The properties associated with absorption will be discussed in the following sections.

a. Partition Coefficient

The partition coefficient is the measure of the lipophilicity of a drug and an indication of its ability to cross the cell membrane. It is defined as the ratio between un-ionized drug distributed between the organic and aqueous layers at equilibrium. The partition coefficient of a drug may be determined by shaking it with equal parts of two immiscible solvents (the organic layer, which is saturated with water, and the aqueous drug solution) until equilibrium is attained. The content of the drug in one of the layers is determined and the value is calculated. Octanol–water partitioning is the system commonly used for the study.

Although the partition coefficient alone does not provide information regarding absorption, it characterizes the lipophilic–hydrophilic balance of a drug and supports the screening of compounds for their biological properties.

b. Permeability in the GI Tract

Permeability is the ability of a molecule to be transported through the GI barrier. Understanding the *in vitro* permeability of a drug allows the prediction of oral absorption and hence its bioavailability.

A drug is absorbed through diffusion across a series of separate barriers where the single layer of epithelial cells is the most significant barrier to absorption. Many *in vitro* methods have been developed for the study of this phenomenon. These methods include small animal gut studies, cell culture (i.e., Caco-2 cell culture model), octanol–water partition coefficients, measures of hydrogen bonding and desolvation energies, immobilized artificial membranes, and retention time on reversed-phase HPLC columns.

Among these testing methods, the small animal GI model and the Caco-2 cell culture model have shown the best correlation with oral absorption *in vivo*. The Caco-2 culture system consists of a monolayer of human intestinal epithelial cells grown on semipermeable supports such as polycarbonate membranes. Because the cells are human in origin, they exhibit many characteristics of the human small intestinal epithelium.³² The permeability coefficients relative to the extents of human drug absorption³³ are listed here:

Drug absorption	Absorption coefficients
Completely absorbed	More than 1×10^{-16} cm/s
More than 1% but less than 100%	0.1 to 1.0×10^{-16} cm/s
Less than 1%	Less than 1×10^{-7} cm/s

This system is widely used in the pharmaceutical industry as an effective model for predicting drug absorption. Other advantages include

- Potential for automation, thus, high throughput robotic operation conducted with cost effectiveness and shortened development time
- Minimal use of animals for experimentation, currently a sensitive issue of society
- Small amounts of drug substance used for multiple testing with the drug substance supply restricted during the earlier discovery stage; processes based on micro technique
- Potential screening method development for testing oral dosage form selection

c. Dissolution Rate and its *in vivo*–*in vitro* Correlation

Dissolution rate determination is the successor of the disintegration test intended for quality control of solid dosage forms such as tablets and capsules. The thinking behind disintegration tests is a simplistic assumption that dosage forms must be disintegrated into small granulates before adsorption. In reality, a disintegration test is a good quality control tool for enteric-coated tablets that tests the ability of the coated tablet to resist disintegration in the simulated GI tract environment. In disintegration test USP, a sample is placed in a specially constructed cylindrical tube with a wire screen bottom. The tube is immersed in a beaker filled with gastric juice maintained at 37°C. The cylinder assembly is controlled by a mechanical device that moves up and down in a reciprocating manner. The disintegration time is at the point at which all disintegrated particles from the tablet escape through the wire mesh and no particles remain in the cylinder.

The dissolution rate is studied originally in a beaker with a stirrer at a constant speed. A tablet is placed in a beaker filled with dissolution fluids, which may be water, simulated gastric juice (without enzyme), or diluted hydrochloric acid. The dissolution fluid is maintained at a constant temperature of 37°C to mimic physiological conditions. The volume of solvent used should maintain a sink condition at all time (generally, the final drug concentration of the dissolution fluid should be less than 10% of the solubility of the drug being tested). The stirrer is installed at a fixed distance above the bottom of the flask in such a way that the tablet will not be crushed by the stirrer. The stirring rate is well controlled, as it affects the dissolution rate by virtue of the thickness of the diffusion layer of the particle. Subsequently, more sophisticated equipment has been developed, with better defined and controlled configurations and conditions, such as shape of the stirrer blade, dissolution flask, stirring rate, deaeration of dissolution media, and vibration effects. The methods of dissolution for solid and transdermal dosage forms are published by the USP; there are five variations known as USP methods 1–5.³⁴

In the study for preformulation, the knowledge of the solubility of the drug substance must be combined with an understanding of dissolution characteristics essential to the development of dosage form to achieve optimal bioavailability and clinical performance. Dissolution of drug substance may be termed *intrinsic dissolution*. The intrinsic dissolution apparatus used for preformulation study is the refined version of Wood's apparatus. A disk compressed with a drug substance is mounted in a rotating head with a specific surface area. The device with the drug substance disk is immersed in the dissolution fluid and maintained at a constant temperature of 37°C, with the same arrangement as that of the rotating basket of the USP method.

The dissolution rate of the drug substance can be calculated from the plot of the concentration of the drug substance as a function of time. Study of the dissolution of metastable polymorph may demonstrate the conversion from the β form to the α form. With the use of the initial rate prior to transition, the solubility of the β form (which is difficult to determine by other means) can be calculated from the dissolution curve.

The original idea behind determining the in vitro dissolution rate was to correlate it with the in vivo absorption rate. The study of half-lives of dissolution rate and absorption rate with acetylsalicylic acid tablets proved to be well correlated.³⁵ Because the concepts of the kinetics of adsorption, distribution, metabolism, and elimination (KADME) were not well understood and because of other technical difficulties in the early stages of pharmaceutical development, the in vitro dissolution and in vitro absorption failed to correlate in some studies. There appeared to be less interest in establishing the correlation. Subsequently, dissolution tests have primarily been used as a quality control process for solid and drug-delivery patch dosage forms. With the advent of pharmacokinetics, more and more studies on correlation are reported. The usefulness of dissolution tests in quality control may finally be extended from product quality to bioavailability. Thus, some correlation between in vivo dissolution and in vitro absorption should be established in the preformulation stage to assist the logical development of dosage forms.

7. Excipient Compatibility Studies

Selection of the excipients such as diluents, binders, disintegrants, lubricants, antiadherants, and glidants for an impending formulation is determined earlier from the preformulation study based on the result of the compatibility experiment. Formulation of a dosage form, especially in solids such as tablets or capsules, requires knowledge of the chemical interaction of the drug substance with adjuvants. Adjuvants or excipients may be numerous in a drug product, as they serve as the functioning agents of the manufacturing process. The excipients facilitate the granulate flow and tablet-compressing operation, as well as providing the product with good bioavailability and patient acceptability. Excipients present in the tablets are bulking and filling agents, disintegrating agents, lubricating agents, coloring agents, taste-masking agents, and stabilizers. They may be found in amounts larger than that of the active substance or in smaller quantities.

A compatibility study focuses on a binary mixture of drug substance and some selected excipients in a fixed ratio with or without added moisture. The

mixture is stored at an elevated temperature in capped vials. The result of the interaction between the active drug and excipients may be determined by techniques such as TLC, high-pressure chromatography, DSC, or solution calorimetry.

A typical compatibility study using TLC and HPLC as monitoring tools is described in the published literature.³⁶ Research also reveals that DSC is becoming increasingly popular as a screening tool for excipient compatibility studies.³⁷ In the study of indomethacin with various excipients (1:1), samples were stored at 37 °C and 50 °C for 1 month. A DSC thermogram obtained with a major thermal change related the interaction of the drug and the excipients. Because no change in thermal behavior was observed, the conclusion was that no solid-state interaction occurred. Compatibility studies using DSC for the drugs dichrofenac sodium and mebeverin hydrochloride have been reported.³⁸

The concern about using DSC alone as a compatibility screening test may be illustrated by the following study. A drug picotamid with some commonly used excipients was studied by the DSC method. The effects on samples of aging and mechanical handling such as blending, grinding, and kneading were studied. In addition to the DSC, a hot stage microscope was also used to observe the thermal changes. The thermal change observed by DSC and thought to be the result of solid–solid interaction was found to be the dissolving of the drug in the melted excipient as observed with the microscope. Inaccurate conclusions could have otherwise been established if DSC alone had been used.³⁹ Because of its simplicity and convenience, DSC has been used extensively and indiscriminately as a screening method for compatibility.⁴⁰ However, proof of the validity of the DSC method in comparison with other analytical techniques for excipient compatibility studies must be well established before the acceptance of this method for screening purposes.

In contrast to the common practice of studying the interaction between a drug substance and excipients as described in the previous section, a proposal had been made that the preparation of initial formulations for stability screening of dosage forms is more meaningful and economical than the test for excipient compatibility in powder mixtures.⁴¹

8. Stability

In a preformulation study, the intent of initiating the stability evaluation is to define a stability detection system that identifies potential degradation products and includes analytical methods for their quantitation. Subsequently, this system is utilized to monitor the degradation process of a new drug either by itself or in a dosage form for a specific period of time, such as the product shelf life.

a. Identification of Potential Degradation Products

Evaluation of the stability of a compound is more accurate and meaningful if it follows the quantitative change in the degradation products rather than the decrease in the intact compound. For most drugs, the change in concentration (of the intact drug molecule as a result of degradation) is small when a determination is made in a relatively short time period, and the precision of the analytical determination is broad. Thus, the accuracy is not reliable.

On the other hand, multiple degradation products may be found, and the toxicity may prove to be significant. Knowledge of the individual species and the amount present is important for ensuring the safety of the product. Furthermore, if the degradation kinetic is a consecutive reaction, the intermediate degradation product present in the product during its shelf life may not be identified if only one sample is taken at one point at the conclusion of the study. An additional advantage of taking several samples over time is to create a degradation rate plot, which may be crucial for the formulator before the conforming kinetic data are available.

b. Forced Degradation

To establish the degradation profile of a new drug, forced or stressed conditions such as hydrolysis, oxidation, photodegradation, and solid thermal decomposition are applied to the drug to generate degradation products that may be monitored by TLC or HPLC.

i. For acid–base hydrolysis, an appropriate concentration of the new drug in 1 N hydrochloric acid or in 1 N sodium hydroxide may be subjected to reflux for 12 h or more. Periodically, a sample of the solution is withdrawn for analysis for degradation products. It is appropriate to take only one point of the refluxed solution after a longer period of heating. For degradation identification, however, it is important to take samples for analysis at several time points. Otherwise, the observation for intermediates may be missed if decomposition proceeds as a consecutive reaction.

ii. For oxidation, the new drug is prepared as a solution and mixed with 20% hydrogen peroxide in a 0.5 N sulfuric acid solution to form a solution with an appropriate drug concentration. An ampule is filled with the solution, and the ampule is sealed and placed in a heating bath for a definite period of time. Periodically, a sample of the solution is withdrawn for analysis for the parent molecule and degradation products.

iii. For photodegradation, an appropriate amount of new drug substance is spread evenly in a Petri dish and subjected to irradiation under a lamp with visible and UV light at a fixed distance. Periodically, a sample of the substance is withdrawn for analysis for intact molecule remains and degradation products.

c. Degradation Product Isolation and Characterization

The degradation products may be resolved from the forced degradation solution by TLC or HPLC. Each degradation product may be subject to limited characterization during the chromatographic process or be isolated as an individual component and subjected to characterization and structure elucidation. These degradation products should be synthesized for other studies such as toxicologic property determination, and authentic samples should be used for quantitative estimation of degradation products.

d. Stability-Indicating Method Development

The only meaningful evaluation of the stability of a drug is to use a stability-indicating method, an analytical method distinguishing the intact

molecule from the degradation products. Ideally, the system should distinguish all degradation products with high resolution from the others. TLC may be used for qualitative identification and semiquantitative estimation in the earlier stage. It would be convenient have a high sensitivity of detection. Ultimately, HPLC with accuracy, sensitivity, and high resolution should be developed for stability testing.

e. Accelerated Stability Program: Storage and Sampling Time

Generally, a considerable waiting period is required to obtain data to establish the expiration date of a drug at shelf temperature (as most of the marketed products are relatively stable). The accelerated stability study, based on the study of rate of degradation in several storage conditions, is frequently used to circumvent this time limitation. Stability programs proposed by the FDA as part of the NDA submission are described below.

Drug samples of adequate amounts for the stability program are placed in a series of closed containers similar to those intended for marketing (miniature size of the market package). These samples are stored under various stress conditions: temperature at 5 °C, 25 °C (ambient temperature), 50 °C and 75 °C, and 75% relative humidity or greater, where appropriate. The samples are exposed to various wavelengths of electromagnetic radiation in the UV and visible ranges (190–780 μm), preferably in open containers.

The sample storage time should be determined so that every degradation can be adequately characterized (i.e., at a sufficient frequency to determine with reasonable confidence the nature of the degradation curve). A stability test may be performed at 3-month intervals during the first year, 6-month intervals during the second year, and yearly thereafter.

Other suggestions include the following conditions for evaluation in stability studies of solutions or suspensions of a bulk drug substance:

- Acidic and alkaline pH
- High oxygen atmosphere
- The presence of added substances under consideration for product formulation

f. Physical Stability of Solid Dosage Forms

Aside from chemical stability, consideration should be given to physical stability as a factor in product integrity in the preparation of solid dosage forms. Physical stability may be viewed as the conversion of an intrinsic physical structure in a solid as it stands for a prolonged period of time in an ambient environment or as the conversion is accelerated by heat or other forms of energy. Changes in physical properties may be spontaneous or gradual. The spontaneous conversion process is detrimental to the stability of a dosage form.

The high-energy state of substances is related to their higher biological activity. A change of state of energy to a lower level usually means loss of potency. For example, a metastable polymorph can be mistakenly chosen as a substance for tablet manufacturing. This high-energy polymorph, which may have higher bioavailability, will convert to the stable polymorph with a lower-energy level on standing. Thus the dissolution rate (a measure of physical

stability) will eventually decrease. Similarly, if a metastable polymorph is used to formulate a suspension product, aggregation will be found on standing. However, if a stable polymorph with a low energy level is used, a stable suspension may result. The physical stability of a suspension may be determined by observing the column height of the suspension in a graduated cylinder.

g. Stability Kinetics and Expiration Date

Obtaining a kinetic date to ensure product stability may not be essential. The design of the accelerated stability program may have taken into consideration certain assumed factors (order of reaction and heat of activation). Thus, the result of the program may be the acceptance of a stable product and an estimated limited expiration date based on observation.

However, an understanding of the reaction kinetics in hydrolysis, oxidation, and photodegradation may increase the knowledge of the degradation mechanism⁴² and often provide elegant alternatives to prevent instability and an accurate determination of the product shelf life (the expiration date).

The kinetics of a drug are generally studied in solution under isothermal conditions. On the other hand, a nonisothermal kinetics study may be carried out in less time at the expense of accuracy. The isothermal solution kinetics include

- Determination of order of reaction
- Temperature effect
- pH profiles of degradation rates
- Solvent effect
- Ionic strength effect

Calculation of the expiration date is based on the Arrhenius equation, the mathematical relationship of temperature and rate of degradation. In addition to the determination of expiration dates, stability studies may be used to identify degradation products that adversely affect product quality. The procedures for accelerating stability testing may be found in compendia such as the USP or European Pharmacopoeia.

Nonisothermal methods for stability prediction use a temperature-programming oven to control the storage environment. Application of nonisothermal stability testing to a drug may provide stability information more quickly than but not as accurately as the isothermal method.⁴³

h. Stability of Phytochemical Products

Phytochemicals (including herbal drugs) are regarded as drug products whose active constituents are crude drugs (herbal ingredients) or preparations of crude drugs (herbal products). A crude drug or preparation of crude drug is considered in its entirety as an active constituent according to the Federal Health Office of Germany. Apparently, this office is the only regulatory agency that has published official stability guidelines on herbal drug products, *Stability Test of Phytochemicals*. Herbal drugs have two classifications: (1) those with known active substances and (2) those with unidentified active substances. For the first category, the stability is evaluated by following chemical and physical changes of products. For the latter case, it is necessary to show groups of

constituents (not more than six) of different polarities separated by chromatography. The fingerprints so obtained serve as the basis for evaluation, provided that the detected constituents are degradable. If practical, biological activity may be monitored as a parameter for stability evaluation.

In addition, two tests are characteristic and important in the stability evaluation of phytochemicals: (1) sensory or organoleptic evaluation and (2) cloudiness due to precipitation in a liquid preparation. If qualitative and quantitative testing cannot be performed, this guideline suggests that physical and sensory tests may be accepted as stability criteria, together with the quality control tests performed (such as testing of starting materials and validation of the manufacturing process).

This guideline for conventional pharmaceuticals may be considered and incorporated into the stability section of preformulation study, when one designs a report for herbal drugs.

i. Stability of Biotechnology-Derived Products

Biotechnology-derived products may be classified into monoclonal antibodies, gene therapy, vaccines, enzymes, and interleukins. The current major therapeutic areas for these substances are cancer or cancer-related conditions, AIDS or HIV-related disease, diabetes, human growth hormone, myocardial infarction, and inflammatory disease.

Most of the dosage forms of the bioactive protein or peptide are liquid preparations. The permeability of the intestinal mucosa to high-molecular-weight substances is very low. However, oral delivery systems may be developed by manipulation of the physicochemical property of the drug molecule or by devising an effective formulation.

Protein drugs are unstable during storage, a condition not commonly found in conventional pharmaceuticals. They are also unstable during production, purification, and formulation. Consequently, handling biotechnology products requires additional precautions and challenges for the scientists involved.

The stability of biotechnology-produced products, proteins (macromolecules), and peptides is unique when compared with conventional pharmaceuticals (small molecules). Protein degradation by both chemical and physical processes leads to the loss of biological activity, whereas peptides decompose only through chemical instability with loss of efficacy and produce undesirable biological effects.

- Chemical stability: due to hydrolysis, oxidation, deamination, isomerization, racemization, epimerization, β elimination, and disulfite exchange
- Physical stability: related to denaturation processes such as unfolding, aggregation, precipitation, or self-association (major degradation pathways)
- Biotechnological stability: also viewed as the ability of the genetically engineered cell line to resist mutation. Such a mutation may result in a change of the genetic code for a protein, thereby producing a protein with a modified amino acid sequence rather than the desired sequence.

The assessment of stability in biotechnology-derived products such as peptides for preformulation is similar to that of the small-molecule drug. Degradation subjected to hydrolysis, oxidation, and deamination influenced by pH, temperature, and buffer species may be studied in the same manner. Protein in solution is not inherently stable. As chemical reactions are retarded in the solid state, a freeze-dried formulation is more suitable for protein product.

E. Format of the Preformulation Report

A collection of models for preformulation reports is suggested. These examples should by no means be considered the standards for everyone. The experience, resource limitation, time demand in delivery, personal preference, and regulatory influence may affect the contents of the report. As discussed, the items in the preformulation are somewhat extensive; a shorter version of the report may be suitable for some companies.

Depending on the structure of the organization, the contents of the preformulation report may be included in several different reports. Typically, the analytical profile may be issued by the analytical development group, and specifications of the drug substance may be issued by the QC laboratory. Physicochemical property determination, stability, compactibility, and pharmaceutical properties may be reported by the basic pharmaceuticals or physical pharmacy group. The biopharmaceutical group may issue the report with KADME and bioavailability data.

This chapter emphasizes the necessity of including all preformulation studies of a new drug compound in one collective report issued in a defined period by a single committee or a working team. The advantage is to move the development cycle with dynamic support from all scientific resources with a defined time goal. The other is to be able to collect in one place all information that is related to formulation development and regulatory registration. Appendices 1, 2, and 3 contain, respectively, the following lists and outlines: Physicochemical Property and Analytical Testing for Drug Substance, Data for Supporting Development of Solid Dosage Forms, and Support for Quality Control and Finished Product Manufacturing.

III. ANALYTICAL TECHNIQUES AND INSTRUMENTS FOR PREFORMULATION STUDIES

A preformulation study is performed to gain insight from physicochemical and biological data into the design and development of dosage forms. Samples are taken in each study and analyzed qualitatively and/or quantitatively, according to the need. Therefore, proper selection of analytical techniques suitable for the purpose of each study is crucial to the success of the investigation.

Analytical techniques are generally divided into two prevalent areas in the specific detection and separation sciences, as explained in the following discussions.

A. Specific Detection

Specific detection is an analytical determination based on specific responses related to the chemical characteristics of a molecule excited by a certain type of irradiation. In this detection method, measurement of the molecule of interest may usually be performed without separation from matrix materials or from other ingredients if appropriate instrumental adjustments are made. The need for identification and structure elucidation for newly discovered compounds drives the progress of specific detection techniques with NMR and X-ray diffraction and MS. The UV-diode array detector often aids the recognition of chromatographic peak purity, ensuring complete resolution of a separation procedure.

Important to quality control are the comparison and confirmation of drug substance identity, excipients, and packaging components. Techniques such as Fourier transform IR (FTIR), attenuated total reflectance (ATR), NIR, Raman spectroscopy are used with increased regularity. The detection of foreign metal contaminants is essential with inductively coupled plasma spectroscopy (ICP), atomic absorption (AA), and X-ray fluorescence. Also notable is the increased attention to analysis of chiral compounds, as in the synthesis of drug substances. Optical rotation, ORD, and CD are currently the preferred instruments for this practice. The analytical techniques commonly used in the preformulation study are discussed in the following.

1. UV Spectroscopy

UV absorptions are mainly electronic in nature and are associated with resonating structures in the molecule. UV absorption is an essential tool for qualitative and quantitative determination of a single component drug or isolated extract. The UV quantitative determination, generally performed in solution, is based on the Beer–Lambert law. This law indicates that the absorbance of the solution of a molecule at its maximum wavelength is proportional to the length of the light path of a cell and the concentration of the solution. The wavelength of the UV spectrum is defined as 200–400 μm .

Quantitative determination of a single drug substance in a nonchromophoric solvent such as an aqueous or alcohol solution may be a good application for the UV method. In a preformulation study, solubility, dissolution rate, and some stability studies (when degradation products have a different absorption maximum from the parent compound) are performed with the UV technique. UV is extensively used for HPLC detection.

2. Visible Photometry and Colorimetry

Visible spectrometry is identical to UV spectrometry, with the exception of the wavelengths, which are 400–750 μm in visible spectrometry.

Most drug substances are colorless; however, a color product may be formed with a specific agent as a result of chemical reaction. Quantitative determination of the colored compound is based on this principle for drug assay. This technique was used quite extensively during the early stages of pharmaceutical analysis in the 1950s and 1960s, when separation techniques were not well developed. Advantages of this colorimetric method include the following:

1. Inexpensive equipment (colorimeter) used for analysis (useful for field tests)
2. Selective detection of a color compound formed (based on chemical selectivity by selective chemical reagents reacting with the compound of interest alone, e.g., functional group analysis)
3. Enhanced detection sensitivity for compounds with low UV characteristics

Another method of forming a color compound (subsequently separated by extraction) is the dye-salt method. In an ion-pair reaction forming a color complex in reaction to the drug with a dye of opposite polarity such as bromthymol blue, the complex is extracted into the organic layer and determined colorimetrically.

Examples of the chemical reaction method are the assay of sulfonamide by the Bratton-Marshall procedure. The drug in solution is reacted with sodium nitrite to form an unstable diazonium intermediate. This unstable salt couples with a reagent yielding a reaction product with an intense color. The dye-salt extraction method may also be exemplified by the assay of atropine. Atropine in solution reacts with bromthymol blue at an appropriate pH. After shaking, the color complex formed is extracted from the aqueous layer into the organic layer and measured quantitatively.

3. IR Spectroscopy

IR spectroscopy is used extensively in pharmaceutical analysis for fingerprint identification of a drug molecule and the proof of its structure. IR absorption bands are characteristic of the functional group of a molecule as well as the structure configuration. The wavelength of the IR spectrum is 750–2500 μm .

The sampling preparation techniques for IR determination are solution, drug dispersion in a KBr pellet, Nujol mulls, and direct determination by microscopic ATR preparation. An example of modern IR equipment is FTIR, which gives better quality determination. Unlike conventional IR (using a dispersed system with a slowly moving mirror to measure each frequency individually), FTIR uses a simple optical device, an interferometer that allows the simultaneous measurement of frequency. Because there are no mechanical movements involved, the determination is rapid. The frequency is calculated with the well-known mathematical technique called Fourier transformation.

In preformulation, IR may be applied to the study of polymorphism of solid crystals. Polymorphs pose different IR characteristics, and they may be used as a tool for fingerprint identification. In certain cases, the absorbance at a selected wavelength is proportional to the amount of specific polymorph present. This relationship may be used for quantitative determination in solid states for a given polymorph. IR has the ability to differentiate isomer groups such as cis-trans double bond compounds as well as position isomers in an aromatic ring.

4. Raman Spectroscopy

Raman spectroscopy is based on the phenomenon of inelastic light scattering. When a particle is irradiated at a certain frequency, radiation scattered by

the molecule contains photons of the same frequency as the incident radiation and may contain photons (weak signal) with a changed or shifted frequency. In FTIR, the molecular bonds that provide weak signals often produce strong signals in FT-Raman, which can be used as a complementary instrument for analytical investigations.

Raman spectroscopy is a nondestructive tool and requires little or no sample preparation. A sample may be analyzed in solid or powder form or in an aqueous solution and placed in glass containers such as an NMR tube, GC vial, test tube, light-path cell, or glass bottle. Aside from structure elucidation and functional group analysis, FT-Raman may be used for quantitative determination of polymorphs in a preformulation study.

5. NIR Spectroscopy

NIR is making significant progress through recent advances in pharmaceutical analysis. The advantage of this technique is the rapidity of analytical determinations without sample preparation and the use of solvent. The NIR spectrum is primarily related to the overtone variation. Hence, the absorption bands are generally weaker than those in the IR. The wavelength of the NIR spectrum is defined as 2500–3000 μm . The detection method is non-destructive. Therefore, it is suitable for use in on-line monitoring and meets 100% inspection requirements in quality control practice. As for instrument construction, the detection probe is built with a diffuse reflection or ATR configurations. With the aid of fiber optics, the detecting probe may be placed several meters away from the analyzer, thus allowing remote testing to be done in the storage area.

The application of NIR in the pharmaceutical industry can be qualitative or quantitative. Analytical samples can be liquid, solid, or vapor. Identification of a sample by fingerprint to compare with the reference standard is an example of a qualitative application. Materials such as active drug substances, organic liquids and solvents, excipients, and packaging materials can be tested rapidly for identity in the receiving area. Other applications encompass the identification of the film layer of coated tablets and the study of blending of active drug substances with excipients calculated by a chemometric technique with the use of computer software.⁴⁴

In quantitative analysis, the instrument must be calibrated with standard samples based on the least-squares analysis of Beer's law. The use of NIR for quantitative determination includes moisture determination for the drying process, assay of dosage form, and content uniformity, as well as dissolution rate monitoring.

6. X-Ray Diffraction

The X-ray diffractometry technique obtains information on substance structure at the atomic level. This technique allows measurement of both crystalline and noncrystalline materials. The analysis is nondestructive in nature and handles samples in the form of powders, solids, and liquids. The X-ray diffraction of a single crystal is employed for the determination of the absolute chemical structure. Powder diffraction is used for fingerprint purposes. Polymorphism may be identified by diffraction patterns with d-spacing that has

broader and overlapping peaks. Quantitative ratios of two polymorphs and their percentage of crystallinity may also be determined.

7. NMR Spectroscopy

NMR involves the absorption of electromagnetic radiation in the radiofrequency of a longer wavelength spectrum. When a sample is placed with atomic nuclei of hydrogen (^1H , protons), fluorine (^{15}F), or phosphorous (^{31}P) in a magnetic field, absorption of energy will occur. The nuclei shift from the preferred orientation with lowest energy to a less preferred, high-energy orientation at a particular frequency. Thus a plot of frequency versus intensity of radiation results in the NMR spectrum of a material. Spectra of NMR can be obtained in liquids or in solids.

a. NMR in Liquids

The liquid technique is widely used for structure elucidation to provide detailed information on the presence or absence of certain magnetic nuclei in different functional groups, along with structural and geometric relationships among the magnetic nuclei. Other applications are for chemical and conformational equilibrium with rate and mechanism of reaction. In NMR analysis with liquids, the sample is commonly dissolved in deuterated solvents (such as chloroform-d, benzene-d, or D_2O) and fills a sample tube.

b. NMR in Solids

Whereas the NMR spectra of liquids are very sharp, the absorption lines of solids are broad and are referred to as "broadline NMR." The major application of broadline NMR is in the measurement of the internuclear distances and other crystal parameters important in the study of polymorphism as well as hydrates and solvates. Solid NMR may overcome the drawbacks of using X-ray diffraction for crystal structure determination. As a single crystal is required for X-ray study, material that cannot be crystallized may not be applied. On the other hand, powder samples are suitable for generating a spectrum to illustrate the crystal structure by the solid NMR technique.

Numerous applications of solid NMR in pharmaceutical studies have been reported. Polymorphic forms observed by X-ray diffraction in drug substances have shown a distinct difference.⁴⁵ One observation of pseudomorphism upon dehydration with disodium chlodronate was made,⁴⁶ with aspartame found to exist in three hydrates, two hemihydrates, and a dihydrate.⁴⁷ In addition to qualitative investigation of polymorphs and solvates, the quantitative measurement of polymorphs is also possible.⁴⁸ The technique for determining a drug substance in dosage form (in the presence of excipients) has been shown to be feasible⁴⁹ and will be helpful for solid-state study. Most techniques currently available require separation of the drug from the excipients. Such separation generally destroys the solid integrity of the drug substance.

8. Mass Spectrometry

A mass spectrometer is constructed with a chamber for vaporization and ionization of the material for analysis. The resulting charged particles (elemental, molecular, and/or fragmental) are then passed through the analyzer.

Depending on the energy spread of the ion beam and the resolution required, the analyzer may be built with a magnetic field (single focusing) or a combination of magnetic and electrostatic fields (double focusing). The resolved ion beams are collected and measured. The spectrometer is operated and maintained in a high vacuum.

9. Metal Analysis

The methods of metal analysis of pharmaceuticals include X-ray fluorescence spectroscopy, AA spectroscopy, and ICP. Most pharmaceutical products are organic substances or biological materials. Active drug molecules rarely contain inorganic or metallic elements, but metallic pharmaceutical compounds such as ferrous sulfate, ferrous gluconate, zinc undecylenate, and magnesium stearate (a commonly used excipient) still exist in the market.

However, the presence of metal in pharmaceuticals, even in trace amounts, is a form of contaminant. For example, metallic ions may act as a catalyst in oxidation that may be detected in drug products. High-sensitivity methods and techniques for metal analysis are essential for quality control. The classical method of detecting metal contamination is the heavy metal testing described in the USP.⁵⁰ This method is a precipitation test with H₂S. The limit is observed by comparing with the standard solution.

Modern spectroscopic methods of metal detection have been developed and utilized. Some of these methods are X-ray fluorescence, AA, and others described in the following sections.

a. X-Ray Fluorescence

When a beam of high-intensity X-rays strikes a sample, the elements in the sample are excited and emit their own characteristic X-rays. The emitted rays are collimated on a crystal (which acts as a diffraction grating), and the light is dispersed in characteristic wavelengths. No preparation is required for the solid sample. Powder samples, solutions, or liquids can be placed in a sample cup wrapped with Mylar film that is transparent to X-rays. Like all X-ray analyses, this method is nondestructive and can be an automatic operation.

b. Atomic Absorption

The AA spectrometer consists of three parts, a light source, a flame atomizer system (includes burner, flame, or graphite furnace with a sample preparator), and a detector. AA and flame photometry are similar, but unlike flame photometry, which measures the intensity of the light emitted from an atomized sample solution, AA measures the light from a particular source absorbed by the flame generated from the sample solution. In AA, the sample in solution is atomized in a flame, producing atomic vapor with elements from the solution. A monochromatic light source with a hollow cathode tube containing the element of interest emits light at the same wavelength as the element of interest passing through the atomic vapor sample in the flame. The amount of radiation absorbed is proportional to the concentration of the elements in the solution.

c. Inductively Coupled Plasma with an Atomic Emission Spectrometer and with a Mass Spectrometer

Plasma gas, argon, is introduced through a series of concentric quartz tubes where the inductively coupled plasma ICP is formed. The torch is located in the center of a radio frequency (RF) coil, through which RF energy is passed. The intense RF field causes collisions between the argon atoms, generating a high energy plasma. The sample introduced in the form of aerosol by the nebulizer is instantaneously decomposed in the plasma (plasma temperature 6,000–10,000 K) to form analyte atoms that are simultaneously ionized. The plasma-optimized coils ensure complete vaporization, de-solvation, dissociation, and excitation of the sample. The ions produced are extracted from the plasma into the atomic emission spectrometer for the case of ICP with an atomic emission spectrometer (ICP-AES). For ICP with a mass spectrometer (ICP-MS), ions are transferred to a high vacuum in an MS. The analyte ions are extracted through two orifices, known as the sampling and skimmer cones, and the analyte ions are then focused by a series of ion lenses into a mass analyzer. The analyzer separates the ions based on their mass/charge ratio. The combination of RF and DC voltages through four molybdenum rods allows the analyzer to transmit only ions of a specific mass/charge ratio. Finally, the ions are measured with an electron multiplier and collected by a counter for each mass number. In the mass spectrum, each elemental isotope appears at a different mass, with a peak intensity directly proportional to the initial concentration in the sample solution isotope.

B. Separation Sciences

Over the last 20 years, separation technology for analytical testing in the pharmaceutical industry has undergone great advances. This progress was motivated by the need for better quality products, the desire for improved knowledge in product development, and, in part, regulatory requirements. Separation techniques such as TLC, HPLC, GC, LC, counter current extraction (CCE), and capillary electrophoresis (CE) are extensively employed in preformulation studies.

I. Thin-Layer Chromatography

TLC has been used for drug development for many years and has proved successful in impurity profiling in drug development. TLC is a separation technique characterized by high sensitivity and multiple detection. In addition, this microscopic technique (it uses a very small sample) is simple and has a short development time. TLC involves inexpensive and portable equipment appropriate to the cost constraints of a laboratory.

The general detection technique is to spray a sample with a detecting agent, which reacts chemically with the ingredient to be detected, so that a visible spot develops. Some universal detection is possible by spraying diluted sulfuric acid on the ingredient after TLC separation. The spot develops under heat, and the heat degradation product in most cases is detected. The degrading molecule usually has higher sensitivity under UV radiation. Detection by visual observation under short- or long-wave UV light is also employed.

The disadvantages of TLC include reproducibility, detection inconsistency, person-to-person variations, documentation, and electronic data reduction.

Instrumentation of TLC has been developed to overcome some drawbacks, especially in quantitative determination. A high-performance instrument has been developed with a fully automated sample applicator, a solvent-developing and -evaporating chamber, a precision-made dryer, a color developing agent sprayer, a light control chamber for visual or photographic observation, and a reflective spectrophotometric detector. Ingenious methods of quantitative determination are available that use a flame ionization detector (FID) and modification of conventional TLC. The analysis is carried out by using a tubular rod coated with silica gel instead of a flat plate as the stationary phase. After the solvent develops and dries, the analytes are removed into the FID detector by a flame moving gradually under the rod.

TLC was introduced as a simple and inexpensive chromatographic technique with good resolution and acceptable speed. The concept has been well accepted by scientists. Although the instrumentation of TLC may have improved the quantitative aspect, the cost increase over conventional TLC methods and the increased popularity of HPLC discourage the use of TLC as the method of choice in separation.

2. High-Pressure Liquid Chromatography

HPLC has contributed many successes in product development and in quality control for the pharmaceutical industry. The UV detector coupling with HPLC equipment is the most important analytical instrument for preformulation, QC/QA, and in-process control in pharmaceutical analysis. HPLC is a basic and reliable analytical tool for preformulation study because of the high-resolution capacity, accuracy, and reproducibility of the equipment. Its primary function includes search for and detection of impurities in drug substances, as well as stability evaluation of dosage forms in terms of detection and quantitation of degradation products.

The micro-bore HPLC system is a modified form of chromatography. The utilization of micro-bore tubes with a stationary coating on the surface instead of conventional columns results in higher resolution, faster speed of separation, and minimal use of solvent.

3. Capillary Electrophoresis

A separate technique employing narrow-bore tubes (10–200 μm i.d.) for high-efficiency resolution of both large and small molecules includes chiral components. In free solution capillary electrophoresis (CE), the separation and migration of the molecules through the capillary are based on electrophoretic migration (based on net charge) and electroosmotic flow (the bulk flow of electrolyte buffer). Other mechanisms for separation depend on molecular size, isoelectric focusing, and hydrophobicity.

Another modification of CE is micellar electrokinetic chromatography (MEKC), which is widely used for the separation of nonpolar compounds. The molecules in question partition into micelles (nonpolar layer) with mechanisms similar to those observed with reverse-phase chromatography. An anionic surfactant, sodium dodecyl sulfate, is commonly used as a micellar

agent. In addition, cyclodextrin, a chiral selector, is added to the system, which contains three phases: aqueous, micelle, and cyclodextrin. Detection is accomplished with UV light, a diode array, laser-induced fluorescence, or a mass spectrometer.

4. Gas Chromatography

GC (also called gas-phase chromatography) is used for speedy separation or for high-resolution separation of volatile or thermal labile substances. GC has good sensitivity, with detection limits of 1 ppb to 100 ppm. Pharmaceuticals such as steroids can form derivatives that are thermally stable in the column to be analyzed by GC. Many detectors are available for GC analysis: thermal conductivity (a universal detector) and other selective detectors, including flame ionization, nitrogen, phosphorous, and electron capture. In addition to the detector, a precise high-temperature-controlled oven with an analytical column, a sample injection port, and a tank of inert gas as propellant complete the GC system. An analytical column with high resolution and the preferred choice in GC determination is the capillary column. A capillary column is a long open tube with a small diameter. The inside wall of the tubing is coated with a film in liquid phase. The tubings have high efficiency, low sample capacity, and low pressure drop.

GC has been the method of choice for drug analysis for many years; however, with the advances in HPLC, GC is utilized less often. It is still used for the analysis of retained solvents, such as the USP test for volatile organic solvents.

5. Ion Chromatography

Ion chromatography is a modified version of HPLC with a capacity for precise and highly sensitive detection of inorganic ions in a complex matrix. Ion chromatography has instrumental configurations similar to those of HPLC: a pumping system, a column compartment, and a detecting system. The solvent used is generally aqueous buffer. The stationary phase is an ion-exchange column, and the detector can be either an electrochemical detector or a colorimeter with a mixer to carry out color formation by chemical reaction with the detected ion. In addition to inorganic ions, organic ions may also be detected.

6. Supercritical Fluid Chromatography

Supercritical fluid chromatography (SFC) uses highly compressed gas above its critical temperature and pressure instead of an organic solvent as the solvent phase. The SFC detecting systems are those commonly used in GC. The major advantage of SFC is the detecting system commonly used in GC, that is, FID, and the allowance in the analysis for thermal unstable compounds.

Gases such as carbon dioxide, nitrous oxide, and ammonia are commonly used. Organic solvents such as methanol, isopropanol, methylene chloride, tetrahydrofuran, and acetonitrile are frequently employed in HPLC as modifiers to increase solvent strength.

C. Thermal Analytical Methods

Equipment for thermal analysis is used extensively for the preformulation study. As in the solid-state investigation, interest is focused not only on the chemical change but also on the physical change, which can be illustrated appropriately by thermometric methods.

1. Differential Scanning Calorimetry

DSC is a precise method of measuring the endothermic and exothermic behaviors of sample materials. Unlike the earlier version of the thermal analyzer, the differential thermometric analyzer (DTA) measures the temperature difference between two cells heating in the same furnace. The power-compensated DSC uses two independent furnaces, one for the sample and one for the reference. When an exothermic or endothermic change occurs in the sample materials, energy is applied to or removed from one or both furnaces to compensate for energy changes in the sample. This means that the system directly measures energy flows to or from a sample at all times.

The advantages of thermal study using DSC include the following.

- Only a microscopic amount of sample is required.
- Little or no sample preparation is needed.
- The automated instrument is simple to operate.
- The detected signal is fed into a computer for interpretation.
- Calculation for quantitative or qualitative studies is readily performed.

2. Hot Stage Microscopy

Changes in thermal properties are observed through a microscope during the heating of a sample placed on a hot stage with a temperature-programming device. Such an instrument is known as a hot stage microscope. Phenomena like melting point can be observed and the temperature at the time of the occurrence can be noted. During the infancy of thermal analysis, many polymorphic studies using a hot stage microscope to observe substances such as barbiturates, sulfonamides, and other drugs were reported by German scientists. The instrument may be considered a complementary one for thermal analysis: DSC or TGA.

3. Thermal Gravimetric Analysis

A thermal gravimetric analyzer is an instrument consisting of a microbalance and a furnace. The sample chamber is connected to an inlet that allows the inert gas to flow through a sample heated by a furnace with a temperature control. Measurement of the weight change (gains and losses) as a function of temperature or time is recorded. Such measurement provides information about the material's thermal stability and compositional analysis (e.g., moisture content of the materials). The gas evolved during the heating process may be detected with FTIR or MS to provide additional information.

TGA may be used to determine moisture content related to weight loss in isothermal or nonisothermal stability studies. In the preformulation study, differentiation of polymorph from hydrate or identification of monohydrate from among other hydrates by DSC alone may not be possible. TGA is the appropriate technique for this purpose.

4. Solution Calorimetry

In a preformulation study, investigation of physical change of a system is required frequently. A sensitive system for detecting the heat given off or taken up during a change in physical properties is important. Solution calorimetry has been used for the study of such polymorphic changes. As different polymorphs have their individual heats of solution, the difference in these values in polymorphs is the heat of transition of the polymorphic change.⁵¹

The method for the determination of the critical relative humidities of some extremely water-soluble compounds is described in a research publication. The determinations by the reported method are in good agreement with that of the conventional method.⁵²

IV. REGULATORY REQUIREMENTS FOR PREFORMULATION

A. Regulatory Compliance

FDA initiatives and other government regulations influence pharmaceutical manufacturing operations, including preformulation studies and quality control systems. These regulatory issues include the topics outlined below.

1. Current Good Manufacturing Practices

The cGMP is an FDA mandatory quality program designed to ensure that pharmaceutical products are consistently produced and controlled according to the quality standards appropriate to their intended use. The cGMP was originally developed for the dosage form or finished product and for bulk drug substances in the absence of a published guideline.

2. Good Laboratory Practice

In contrast to cGMP, which regulates manufacturing and its related quality control activities, good laboratory practice (GLP) covers research activities. The most significant difference between the two sets of guidelines is in the requirements of archiving for test samples and data. All raw data, documentation, standard operating procedures (SOP), protocols, final reports, and specimens (with some exceptions) must be retained. The archiving facilities must be constructed to allow orderly storage and expedient retrieval of these items.

GLP regulates all nonclinical studies and was originally intended for toxicity testing only. The requirements of analytical measurements and methods in support of toxicological studies are included in the GLP. The QA/QC may serve as the quality assurance unit (QAU), which is responsible for monitoring each study to ensure that management facilities, equipment, personnel, methods, practice, controls, SOPs, and final reports conform to the regulation.

3. International Conference on Harmonization

The ICH is intended to avoid duplication efforts for product registration and manufacturing in world trade. The FDA has been working in a forum

with its counterparts and private industry from the United States, the European Union, and Japan to harmonize regulatory criteria and procedures.

Ultimately, there will be one set of global requirements. The areas of interest for harmonization include the following topics:

- Stability testing
- Quality specification (including impurities)
- Validation of manufacturing procedures and analytical methods
- CMC sections for product registration
- Contents of pharmacopoeia
- Toxicity testing
- Clinical testing of biotechnology-derived products

B. Quality Control for a Preformulation Study

The following areas of involvement are the responsibility of the analytical laboratory where most of the preformulation data are generated.

1. Personnel Qualification and Training

The GMP specifies that the person engaged in the pharmaceutical operation must have the necessary education, training, and experience to perform the assigned functions. Training in cGMP and in the area of function should be provided. FDA inspection frequently includes the review of personnel training records; therefore, good recordkeeping of personnel attending scientific meetings and professional training courses should be maintained.

2. Analytical Method Validation

Preformulation performed before the NDA stage is discovery research and should not be governed by FDA guidelines. However, data used in the IND and NDA are subject to GLP/cGMP compliance and must be validated.

Validation may be viewed as the documentation of evidence that a system does what it purports to do. Thus, analytical method validation is the maintenance of documentation in experimental databases to verify that an analytical method performs in the manner intended. The validation report should include the following.

- Written analytical procedure
- Instrument calibration
- Validation parameters: accuracy, precision, linearity, sensitivity
- System suitability criteria: the minimum acceptable performance criteria before each analysis

The details of analytical method validation may be found in the USP and FDA guidelines, ICH, or other publications.

3. Documentation and Standard Operating Procedures

According to the cGMP, compliance investigation reports must be documented for process, procedure, and protocol. The quality and authenticity of the document must be reviewed by management and retained for reference.

An important role of the analytical laboratory is to archive all reports and data generated and to be able to retrieve the documents in a reasonable time. Thus, technical writing and data management become an integral part of analytical laboratory services. Directions for notebook writing intended for patent application must be followed and can be used as legal evidence of an invention.

The critical part of documentation is the preparation of the SOP. SOP is a set of guidelines written to define the activity of a specific operation. In addition to preformulation, other operations, including quality control procedure, materials handling, manufacturing process, equipment calibration and maintenance, cleaning, stability storage, and evaluation, should be prepared before their occurrence. The SOP must be reviewed and issued by the management responsible for the operation. In addition, periodic review and revision of the SOP should be conducted.

V. SUMMARY AND CONCLUSIONS

The intent of a preformulation study is to provide data and information regarding a drug substance and manufacturing technology before the planning of formulation development activities, including product design of a drug. This includes the preparation of a report and its presentation or documentation to the formulators in a scientific mode to assist the development venture. With the data and information provided, the finished product will be built on principles and technical practice, considering analytical profiles, chemical physical properties, QA/QC practice, modern manufacturing procedures, stability, and biopharmaceutical properties.

The cycle of pharmaceutical development with stages and milestones such as discovery, IND, NDA, and market introduction is discussed in this chapter. The discussion also demonstrates the fit of the preformulation into the total development activities. The contents of the preformulation reports illustrated are comprehensive in comparison with the conventional definition in preformulation. Although basic pharmaceutical principles and theory are not included in this chapter, literature references are provided. The expedience of providing documents in one volume (with three subparts) for the formulator is emphasized.

In this chapter, pharmaceutical and health-care products, such as prescription drugs, generic drugs, OTC products, animal health products, dietary supplements (vitamins and herbal drugs), and biotechnology-derived products, are discussed in relationship to the format of preformulation reports. Topics of the preformulation study are discussed in detail. Models for some of the reports are provided in the hope that the pharmaceutical development team will devise an individual report format based on particular needs and resources. Analytical techniques useful for preformulation and regulatory conformity or requirements relative to product registration processes are also enumerated.

APPENDIX I: PHYSICOCHEMICAL PROPERTIES AND ANALYTICAL TESTING FOR DRUG SUBSTANCE

Chemical Structure

Empirical Formula	Molecular Weight
Lot # of Drug Used:	Reported By:
Assay:	Position:
Reference: Notebook #	Date of Report Issued:

1. Chemical Properties

Chemical structure
Molecular weight
Empirical formula
Elemental analysis (C, H, N, O, Cl, etc.)

2. Identification of Drug Substance

UV
IR
NMR
Mass spectroscopy
TLC R_f and HPLC retention time
Melting point
 Range
 Method (USP 1 or 2, etc.)
Others

3. Titration Methods

Nonaqueous titration with curve (Figure ____)
Other titration methods

4. Chromatographic Techniques and Method Description

TLC
HPLC
GPC
Others

5. Proposed Assay Methods for Drug Substance

Titration
 UV
 HPLC
 GC
 Others

Description

6. Synthetic Impurities

Starting materials a:	name and structure
Pivotal impurities b:	name and structure
Degradant from synthesis c:	name and structure
Other minor impurities d:	name and structure

Description of Method of Detection

7. HPLC Data

Impurities	Retention Time
1.	
2.	
3.	

Typical chromatogram attached (Figure ____)

Comments _____

8. Optical Rotation

Typical spectrograph attached (Figure ____)

Comments _____

9. Solubility

Solubility in water and organic solvents: ____ mg/ml

Aqueous Solubility as a Function of Temperature

Temperature (°C)	Solubility (mg/ml)
_____	_____
_____	_____
_____	_____
_____	_____

Aqueous Solubility at Various Buffered pH Values

pH	Solubility (mg/ml)
_____*	_____
_____*	_____
_____*	_____
_____*	_____

*Buffer system

Solubility with Surfactants

Surfactant/Concentration	Solubility (mg/ml)
_____	_____
_____	_____
_____	_____
_____	_____

10. Dissociation Constant, pK_a

pK_a value:
Method of determination:

11. Partition Coefficient

Value:
System:

12. Loss on Drying

Drying temperature:
Time period:
Condition: in oven, in vacuo
LOD in percent:

APPENDIX 2: DATA FOR SUPPORTING DEVELOPMENT OF SOLID DOSAGE FORMS**Chemical Structure**

Empirical Formula	Molecular Weight
Lot # of Drug Used:	Reported By:
Assay:	Position:
Reference: Notebook #	Date of Report Issued:

1. Revised Data Previously Published in Part I**2. Surface Characteristics**

Particle shape
 Microscopic technique
 Image analyzer
 Particle size distribution
 Sieving analysis
 Total surface area
 BET

3. Powder Characteristics

Density
 Bulk density
 Flow properties
 Angle of repose
 Compressibility
 Mixing and blend uniformity

4. Hygroscopicity and Moisture Absorption-Desorption

% RH

% Moisture Uptake

Adsorption/Desorption Isotherm (Figure ____ attached)

5. Dissolution Rate Determination

Intrinsic Dissolution

Conditions:

Surface area:
 Rotating rate:
 Method:
 Dissolution medium:
 Volume of solvent:
 Temperature:
 Analytical method

Result:

Typical dissolution profile (Figure ____ attached)

Dissolution of Proposed Dosage Form

Conditions:

Sample lot #
 USP method:
 Stirring rate/flow rate:
 Dissolution medium:
 Volume of solvent:
 Temperature:
 Analytical method:

Result:

Typical dissolution profile (Figure ____ attached)

6. Proposed Method of Analysis for Dosage Form

- Content uniformity/unit blend analysis
- Finished product analysis
 - HPLC
 - GPC
 - NIR
 - Capillary electrophoresis
 - Others

7. Stability Evaluation

For drug substances (lot # _____)

Stability-indicating method:

Stress degradation study

Condition:

Component	Retention Time
Main compound	
Degradation product 1 (Major)	
Degradation product 2 (Minor)	
Degradation product 3 (Minor)	
Degradation product 4 (Minor)	

8. Excipient Compatibility Studies

9. Polymorphism, Hydrates, Solvates, and Amorphous Solid

- Polymorphism
 - Method of determination:
 - DSC (thermogram attached, Figure _____)
 - Solubility (Arrhenius plot attached, Figure _____)

Polymorph A (stable) m.p.: XRD: IR: NMR (solid):

Polymorph B (metastable) m.p.: XRD: IR: NMR (solid):

Transition temperature:

By DSC or solubility

Hydrates or solvates

Method of determination:

DSC (thermogram attached, Figure _____)

TGA (thermogram attached, Figure _____)

Solubility (Arrhenius plot attached, Figure _____)

Amorphous powder

APPENDIX 3: SUPPORT FOR QUALITY CONTROL AND FINISHED PRODUCT MANUFACTURING

Chemical Structure

Empirical Formula	Molecular Weight
Lot # of Drug Used:	Reported By:
Assay:	Position:
Reference: Notebook #	Date of Report Issued:

1. Preformulation data previously published but updated with advanced technique are included in this report
2. Interim developed product intended for “Biobatch”
 - Finalized formulation for biobatch:
 - Excipient characteristics and justification:
 - Specifications:
 - Analytical methods:
 - Issues in QA/QC:
 - In-process control
 - Method validation for biobatch, Lot # _____
 - Consideration and protocol
3. Bioavailability

REFERENCES

1. Martin, A. N., Swarbrick, J., and Cammarata, A. *Physical Pharmacy*, 2nd ed., Vol. 2. Lea and Febiger, Philadelphia, 1969.
2. Wagner, J. G. and Pernarowski, M. *Biopharmaceutics and Relevant Pharmacokinetics*, 1st ed., Vol. 2. Hamilton Press, Hamilton, IL, 1971.
3. Romero, A. J. and Rhodes, C. T. *Drug Dev. Ind. Pharm.* 17(5):777, 1991.
4. Tong, W. Q. and Whitesell, G. *Pharm. Dev. Technol.* 3(2):2115, 1998.
5. Torres, A. I., Gil, M. E., and Camacho, M. A. *Drug Dev. Ind. Pharm.* 21(2):185, 1995.
6. Serajuddin, A. T. M., Sheen, P. C., Mulfson, D., Bernstein, D. F., and Augustine, M. J. *Pharm. Sci.* 75(May):492, 1986.
7. Gu, O., Huynh, A., Becker, P., Chu, N. et al. *Drug Dev. Ind. Pharm.* 13(3):437, 1987.
8. Jakobsen, D. F., Frokjaer, S., Larsen, C., Niemann, H., and Buur, A. *Int. J. Pharm.* 156:67, 1997.
9. Rosenstock, J. *The Law of Chemical and Pharmaceutical Invention: Patent and Nonpatent Protection*. 2nd ed. Aspen Publishers, Gaithersburg, MD, 1998.
10. Rosenstock, J. *Analytical Profiles of Drug Substance and Excipients*. Academic Press, New York, 1998.
11. *United States Pharmacopeia*, Vol. 24. Rockville, MD, 2000.
12. *The British Pharmacopoeia*, 1988.
13. Higuchi, T. and Connors, K. A. *Adv. Anal. Chem. Inst.* 4:117, 1965, Wiley, NY.
14. Grady, L. T., Hayes, S. E., King, R. H., Mader, W. J., Wyatt, D. K., and Zimmerer, R. O. *J. Pharm. Sci.* 62:456, 1972.
15. Carstensen, J. T. *Theory of Pharmaceutical Systems*, Vol. II. Academic Press, NY, 1973.
16. Neumann, B. S. *Adv. Pharm. Sci.* 2:197, 1967.
17. Wells, J. I. *Pharmaceutical Preformulation*, pp. 211–214. Ellis Horwood, Chichester, England, 1988.
18. Marshall, K. *Drug Dev. Ind. Pharm.* 15(13):2153, 1989.
19. *United States Pharmacopeia*, Vol. 24, p. 1941. Rockville, MD, 2000.
20. *USA vs. Barr Laboratories*, 2-4-93.
21. Higuchi, W. I., Lau, P. K., Higuchi, T., and Shell, J. W. *J. Pharm. Sci.* 52(2):150, 1963.

22. Milosovich, G. *J. Pharm. Sci.* 53:484, 1964.
23. Shefter, E. and Higuchi, T. *J. Pharm. Sci.* 52:781, 1963.
24. Huskey, C. F. and Melnitchenko, V. *J. Pharm. Sci.* 51:1298, 1965.
25. Maurin, M. B., Rowe, S. M., Rockwell, A., Foris, C. M., and Hussain, M. A. *Pharm. Res.* 13:481, 1996.
26. Mullins, J. D. and Macek, T. *J. Pharm. Sci.* 49:425, 1960.
27. Chiang, C. C., Longer, M., Tyle, P., Fessler, D., and Shetty, B. *Int. J. Pharm.* 117(18):197, 1995.
28. Bergeron, M., Laurin, P., and Tawahshi, T. *Drug Dev. Ind. Pharm.* 12(6):915, 1986
29. *United States Pharmacopeia*, Vol. 24, p. 1858. Rockville, MD, 2000.
30. Byrn, S. R. *Solid State Chemistry of Drugs*, p. 103, Academic, NY, 1999.
31. Carstensen, J. T. *Pharmaceutical Principles of Solid Dosage Forms*, p. 191, Technomic Publishing, Lancaster, PA, 1993.
32. Bailey, C. A., Bryla, P., and Malick, A. W. *Adv. Drug Delivery Rev.* 22:85, 1996.
33. Artursson, P. and Karlson, J. *Biochem. Biophys. Res. Commun.* 175(3):880, 1991.
34. *United States Pharmacopeia*, Vol. 24, p. 1941. Rockville, MD, 2000.
35. Levy, G., Gumtow, R. H., and Rutowski, J. M. *Can. Med. Assoc. J.* 85:414, 1961.
36. Jacobs, A. L. *Pharm. Man.* 2:42, 1985.
37. Vankartaram, S., Khohlkwane, M., and Wallis, S. H. *Drug Dev. Ind. Pharm.* 21(7):847, 1995.
38. Al-Gohary, O. M. *Pharm. Ind.* 60(2):168, 1998.
39. Mira, P., Faucci, M. T., Manderioli, A., Furlanetto, S., and Pinzuati, S. *Drug Dev. Ind. Pharm.* 12(6):915, 1986.
40. Erram, S. V. and Tipnis, H. P. *Indian Drugs* 30:61, 1993.
41. Monhouse, D. C. and Maderich, A. *Drug Dev. Ind. Pharm.* 24(8):747, 1998.
42. Garrett, E. R. *Adv. Pharm. Sci.* 2:1, 1967.
43. Ellstrom, K. and Nyqvist, H. *Acta Pharm. Suec.* 24(3):115, 1987.
44. Ciurczak, E. W. *Pharm. Technol.* 15(9):42, 1991.
45. Byrn, S. R., Gray, G., Pfeiffer, R. R., and Frye, J. *J. Pharm. Sci.* 74:565, 1985.
46. Timonen, J. T., Pohjala, E., Nakander, H., and Pakkannen, T. *Pharm. Res.* 15:110, 1998.
47. Zell, M. T., Padden, D. E., Grant, D. J. W., Chapeau, M. C., Prakash, I., and Munson, E. J. *J. Am. Chem. Soc.* 121:1372, 1999.
48. Suryanarayantun, R. and Wiedmann, T. S. *Pharm. Res.* 7:184, 1990.
49. Byre, S. R., MacKanzie, A. T., Hassan, M. M. A., and Al-Badr, A. A. *J. Pharm. Sci.* 75:596, 1986.
50. *United States Pharmacopeia*, Vol. 24, p. 1858. Rockville, MD, 2000.
51. Lindenbaum, S. and McGraw, S. E. *Pharm. Man.* 27, 1985.
52. Jacobsen, D. F., Frokjaer, S., Larsen, C., Niemann, H., and Buur, A. *Int. J. Pharm.* 156:67, 1997.

This Page Intentionally Left Blank

6

SOLID DOSAGE-FORM ANALYSIS

PHILIP J. PALERMO

Purdue Pharma, 444 Saw Mill River Road, Ardsley, New York 10502

- I. INTRODUCTION
 - A. Background and Scope
 - B. Separation Techniques
 - C. Quality-Related Regulatory and ICH Influences
 - D. Role of the Analytical Group
 - E. Tests and Specifications
- II. PHYSICOCHEMICAL CHARACTERIZATION TECHNIQUES
 - A. Microscopy
 - B. X-Ray Powder Diffraction
 - C. Thermal Analyses
 - D. FTIR Microspectroscopy
 - E. NMR Spectroscopy
 - F. Mass Spectrometry
 - G. Raman Spectroscopy
- III. NEAR-INFRARED ANALYSIS
 - A. Qualitative NIR Analysis
 - B. Quantitative NIR Analysis
- IV. AUTOMATION
 - A. Fiber-Optic Dissolution System
 - B. Flow Injection Analysis
 - C. Robotics and Laboratory Automation
- V. FUTURE DIRECTIONS
- VI. SUMMARY
- ACKNOWLEDGMENTS
- REFERENCES

I. INTRODUCTION

A. Background and Scope

Solid oral dosage forms provide a highly reproducible and convenient form of drug delivery. Generally easy to manufacture and stable, they are the most common form of self-medication. Immediate-, controlled-, and extended-release solid oral dosage forms are easy to manufacture reproducibly and provide convenient delivery systems for self-administered medications. To design effective delivery systems, it is important to understand the behavior and characteristics of the active pharmaceutical ingredient (API) when it is incorporated into polymers that are used to modify its physical state or control its release in the gastrointestinal tract. These formulations often present considerable challenges to the pharmaceutical chemist.

Solid oral dosage forms are designed to deliver the drug through physiological mechanisms that preside throughout the gastrointestinal tract.

To design an effective delivery system, it is important to know the physical state of the API in the dosage form; therefore, this chapter will focus to a large extent on the solid-state aspects of the solid oral dosage forms. Tests that demonstrate that the state of the API within the dosage unit is in a specified, physical form increase the dependability and understanding of product performance.

One focus of this chapter will be on techniques that facilitate development or predict product performance, i.e., nondestructive and noninvasive *in situ* techniques that do not alter the dosage unit itself. Included are new technologies or new applications of existing technologies that help us understand the factors that affect product performance and quality. To facilitate the development of immediate, controlled, and extended release and other types of solid dosage forms, noninvasive and nondestructive *in situ* techniques provide insight into the physical nature and microhomogeneity of the dosage form. These techniques include light microscopy, polarized light microscopy (PLM), scanning electron microscopy (SEM), transmission microscopy, Fourier transform infrared (FTIR) microspectroscopy, nuclear magnetic resonance (NMR) imaging, near-infrared (NIR) analysis, and Raman spectroscopy.

The second focus of this chapter will be on high-throughput techniques for the assessment of product quality. These techniques—NIR analysis, fiberoptic dissolution, robotics, and flow injection analysis (FIA)—promise to allow the analyst more time for problem solving, invention, and interaction with the analytical department's multiple customers.

B. Separation Techniques

Techniques that involve crushing, dissolving, or extracting the API from the dosage form often destroy much of the critical information about the physical characteristics of the sample. Therefore, they are unlikely to provide much information about physical or performance-related attributes of the dosage form. Because preparation of a sample for chromatographic analysis involves the use of destructive sample preparation techniques, chromatographic methods will not be discussed in this chapter, even though high-performance liquid chromatography (HPLC) is a dominant technique that has been routinely used during the last 20 years for assay and impurity determinations. Several worthwhile HPLC treatises are readily available.^{1–6}

Though intriguing and promising new chromatographic techniques such as capillary electrophoresis, capillary electrochromatography, and micellar electrokinetic chromatography continue to be developed, applications for finished solid oral dosage-form analysis are just beginning to appear.^{7, 8} The use of capillary techniques has increased because of the need for chromatographic alternatives to HPLC. Capillary electrophoresis and related techniques are capable of high separation efficiencies, but they are often limited by injection imprecision, viscosity effects, electro-osmotic flow, and sample capacity. An excellent review of these techniques with applications to dosage-form analyses was recently published.⁹

C. Quality-Related Regulatory and ICH Influences

Solid oral dosage forms were the first dosage forms to be considered for worldwide regulation by the International Conference on Harmonization (ICH). The ICH is a collaborative effort by both industry and regulatory bodies of the United States, the European Union, and Japan, in whose proceedings and deliberations this author was privileged to play a role.^{10–12} The ICH Quality Section concentrated its efforts on the development of guidelines for method validation and stability studies and specifications for impurities and residual solvents. These guidelines are excellent sources of information regarding the development of and requirements for analytical methodology and validation.

In addition, the ICH proposed guidelines for the development of specifications related to drug substance and drug product performance (ICH Q6A and decision trees).¹³ To increase the understanding of product performance and ensure that the product will function as expected, the tests discussed in this chapter include noninvasive and nondestructive *in situ* tests which ensure that the API incorporated into the dosage unit is in a specified, physical form.

D. Role of the Analytical Group

Throughout the drug development process, analytical scientists play a pivotal role. The data package they create lends credence to any submission and is a principal component in the Chemistry, Manufacturing, and Controls (CMC) section. There are many examples of the analytical group's key role. For example, to support the development of a lower-strength dosage form for a product line extension, a different packaging style for an approved product, or a change in the source of a raw material, the analytical group may be the only group involved. And though the Food and Drug Administration (FDA) scale-up and post-approval change (SUPAC) guidelines are replete with shortcuts to the redevelopment process, there is no significant section of the guidelines where the need for supporting analytical data is waived.

In the early phases of drug development, the analytical group is involved in discovery and synthesis support. This support comprises characterization of the impurities and degradants in the API and dosage form, elucidation of reaction mechanisms, determination of physical and chemical constants, conduct of preformulation and excipient compatibility studies, analysis of competitors' products, stability studies, and testing for product release. As the drug development process proceeds, chemists continue to develop and validate test methods as well as participate in process development and equipment cleaning validation studies, market stability, and technology and method transfer. An often related activity requiring analytical support is technology development and the resulting patent support and obtaining of patents.

E. Tests and Specifications

As the modern analytical laboratory evolved, the predominant emphasis was on measurements that demonstrated the purity, identity, and potency of the dosage form. In the latter half of the twentieth century, tests and specifications

that measure parameters such as hardness, disintegration, and dissolution were added as an attempt to ensure consistent product performance. Many of the principles of pharmaceutical analysis that Daniel Banes published a quarter of a century ago such as “effectual specificity” are finally being implemented.¹⁴

Recently, ICH guidance Q6A has simplified the development of specifications in several ways, not the least of which is the clarification that impurities if already controlled in the API do not have to be controlled in the dosage form unless they are also degradants. For the release assay, this paves the way for simpler, but no less sophisticated methods that require minimal sample preparation. Thus, the future may bring a return to spectroscopic techniques such as ultraviolet/visible (UV/vis) spectroscopy. There also may be increased use of other high-speed and high-precision techniques such as flow injection analysis (FIA) and near infrared (NIR) analysis.

Typical tests involved during development and their usual applicability are shown in Table 1. The use of these tests varies widely according to the requirements of the particular region of the world where the product will be marketed. The results of these tests and their effect, if any, on product effectiveness should demonstrate which tests are critical and need to be incorporated into the final product specifications. Tests that invariably become a part of the final product specifications are identity, assay, content uniformity, disintegration or dissolution, degradation products and tests such as visual inspection.

An identity test ensures that the correct drug is in the drug product. Often, two identity tests are employed: a specific spectroscopic test, such as infrared spectroscopy, and a chromatographic retention time test. These tests must be capable of distinguishing between the API and its related compounds and salt forms, and they should be specific for the API in the presence of the components of the matrix. In the case where the utility of the dosage form is dependent upon a particular polymorph or stereoisomer, another identity test specific for these properties may be required.

The tests for assay, blend uniformity, and content uniformity usually represent a high laboratory resource burden during development and product release. They provide some information on batch execution, but little relevant information regarding its potential performance. These tests are often implemented with an assessment of 30 tablets or less, which might represent an entire production run of 100,000 tablets or more. In an overwhelming number of cases, the assay and content uniformity tests are based upon HPLC. For stability-indicating methods, chromatography (also usually HPLC) is required because of the need to monitor or separate possible degradants. HPLC is also the release method of choice for the analysis of drug mixtures. HPLC exhibits good linearity, specificity, and precision, but it is slow and sequential and carries with it high data storage and system suitability requirements.

The quantitation of degradation products is critical for ensuring quality. Occasionally, degradants can be toxic, and their presence may indicate a production process that is out of control, poor or inappropriate packaging materials, or improper storage. Methods for the determination of degradation products should be capable of detecting degradants that already have been observed and have the built-in capability to detect possible new degradants should they occur. HPLC has become the method of choice for the quantitation

TABLE I Typical Tablet and Capsule Specifications for Product Release and Stability Monitoring

Test	Details	Required tests	
		Initial analysis	Stability
Appearance of product			
Tablets	To include color, shape, type of coating, markings, and printing	X	X
Capsules	To include capsule color, brittleness, printing, and description of contents	X	X
Appearance of package	Exterior and interior	X	X
Identification of active constituent(s)	By two different methods, one of which includes confirmation of the salt, if any	X	
Assay of active content(s)		X	X
Uniformity of contents (dose)	Between individual dosage units, if required, depending upon dosage strength/weight	X	X
Degradation products	To include individual named, individual unnamed, and total	X	X
Residual solvent(s) levels	Only if solvents were used	X	
Dissolution(s)	Mean and individual values for six units for each active	X	X
Moisture content	Tablets, capsule, and contents	X	X
Identification of dyes	If a dye is used	X	X
Dimensions			
Round tablets	Diameter and thickness	X	
Shaped tablets	Thickness, length, breadth	X	
Capsules	Capsule size	X	
Hardness	Tablets only	X	X
Average weight		X	X
Uniformity of weight		X	X
Friability	Tablets only	X	X
Disintegration time		X	X
Microbial limits	Total viable count for aerobic bacteria and yeasts/molds, total Enterobacteria, absence of pathogenic Enterobacteria, <i>Pseudomonas aeruginosa</i> , and <i>Staphylococcus aureus</i>	X	X
pH	For soft gelatin capsules	X	X
Leakage	For soft gelatin capsules	X	X
Pellicle formation	For soft gelatin capsules	X	X

of degradants and is frequently combined with the assay test. Conventional HPLC usually demonstrates adequate resolution in the separation of drug substances and their homologues. Even with the limited number of theoretical plates of an HPLC column (as compared to a gas chromatography column), there is often enough separation of the drug substance from related substances and excipients at fairly low detection levels, assuming a suitable chromophore.

Disintegration and dissolution represent the industry's best effort toward a test to ensure product performance. These 25-year-old methodologies [U.S. Pharmacopoeia (USP) disintegration, dissolution, and drug release] are often labor intensive, however, and therefore represent the greatest opportunity for modernization and automation; they will be discussed later. The dissolution test has been applied quite successfully as a quality control test to ensure consistency of manufacture. In recent years, increasing emphasis has been placed on its use as a tool to predict bioavailability. Thus, there is an emphasis on the design of the dissolution and drug release test that correlates with bioavailability and bioequivalency.

As a reflection of the importance of dissolution testing to the industry, the USP lists at least seven different laboratory apparatuses for the determination of *in vitro* release rates of drugs from their pharmaceutical dosage forms. USP apparatus 1 (baskets) and apparatus 2 (paddles) have dominated the applications for solid oral dosage forms, but recently there has been an increase in the use of apparatus 4 (flow-through cell). Although there are general norms and guidances regarding the dissolution media, volume, stirring rate, and temperature to be used with each type of apparatus, the choice of conditions should be based entirely upon the ability to detect product variation, stability changes, polymorphic changes, and correlation with *in vivo* results where these studies have been performed.

In several instances the marketplace has seen the introduction of supposedly equivalent drug products. Although the contents of the API were identical and the dosage forms very similar, there was a large discrepancy in between their *in vitro* and *in vivo* performance. Thus, in the last decade there has been an increasing emphasis on the development of *in vitro/in vivo* correlations (IVIVC). This has become so important that the recent extended, release dosage form guideline¹⁵ states that "any" dissolution test can be used to establish IVIVC. These initiatives were the subject of many recent workshops attended by representatives from industry, academia, and regulatory agencies around the world. These studies are now expected for New Drug Applications (NDAs), ANDAs, and AADAs and their corresponding worldwide applications.

Although the establishment of a good IVIVC can be a significant undertaking across the analytical, pharmaceuticals, and biopharmaceuticals departments, it can also be of great advantage to the sponsor company. In SUPAC situations involving formulation, process, equipment, and site of manufacture changes, expensive and time-consuming bioequivalence studies may be waived in lieu of equivalent dissolution results obtained with the established IVIVC method. When available, the IVIVC is now the principal determinant in the setting of dissolution specifications.

The visual inspection test is important for both bulk drug products and packaged products. Depending upon the product, visual inspection can indicate deterioration resulting from improper storage conditions or contact with packaging components. Packaging effects on solid oral dosage forms are usually not as critical as those for liquids, suspensions, or semisolids; however, some deleterious effects have been observed, such as off-color tablets resulting from the bleaches used to clean and whiten cotton.

Other aspects of product performance should be considered in a specification. For example, in an immediate-release tablet, the drug should dissolve in a few minutes, not 45 minutes or longer. A controlled-release product should deliver the drug within the profile defined during development. Thus, tests that demonstrate that the state of the API within the dosage unit is in the specified physical form may increase the reliability of product performance.

II. PHYSICOCHEMICAL CHARACTERIZATION TECHNIQUES

Physicochemical characterization techniques are beginning to play a major role in the drug development process because they help us to understand the mechanism of drug delivery. Demonstration of this understanding is expected by the regulatory agencies and is usually an important component of the pharmaceutical development report.

Dissolution is the first step in drug delivery by solid oral dosage forms, but the determination of *in vitro* release profiles provides little, if any, understanding of the mechanism of the release of API from the product matrix. An assessment of the internal structure of the dosage form and the microhomogeneity and morphology of the API in the dosage form can be made with the techniques that are discussed in this chapter. These techniques include microscopy and energy-dispersive X-ray spectroscopy, X-ray powder diffraction, thermal analysis, FTIR microspectroscopy, NMR imaging, mass spectrometry, and Raman spectroscopy. The collection and interpretation of the results obtained from these techniques can be used to optimize formulation development and ensure the consistency, quality, and stability of solid dosage forms.

A. Microscopy

Light microscopy, PLM, SEM, and transmission microscopy are nondestructive techniques that can provide insight into the composition and homogeneity of the API throughout the dosage form. These techniques can lead to an understanding and sometimes a prediction of the dosage form's performance characteristics, such as the dissolution profile, ruggedness of the product, and potential flaws in the coating that imparts the controlled-release characteristics to the product.

PLM and energy-dispersive X-ray spectroscopy (used in conjunction with SEM) were utilized to determine how an API is distributed within a granulation. A polarized light micrograph of a cross section of the granulation matrix is shown in Figure 1. Crystals of the intact API are plainly visible within

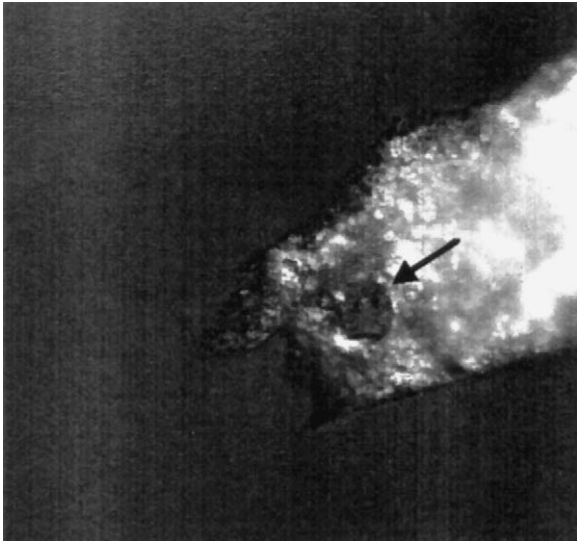

FIGURE 1 Polarized light micrograph of a granulation. Crystals of the API (see arrow) are visible within the matrix of the granulation.

the matrix. Because the API is a hydrochloride salt, energy-dispersive X-ray spectroscopy, an elemental analysis technique, was used to map chlorine content (Fig. 2) and reveal the distribution of the API in the granulation. These experiments demonstrate that the API exists as the hydrochloride salt in the

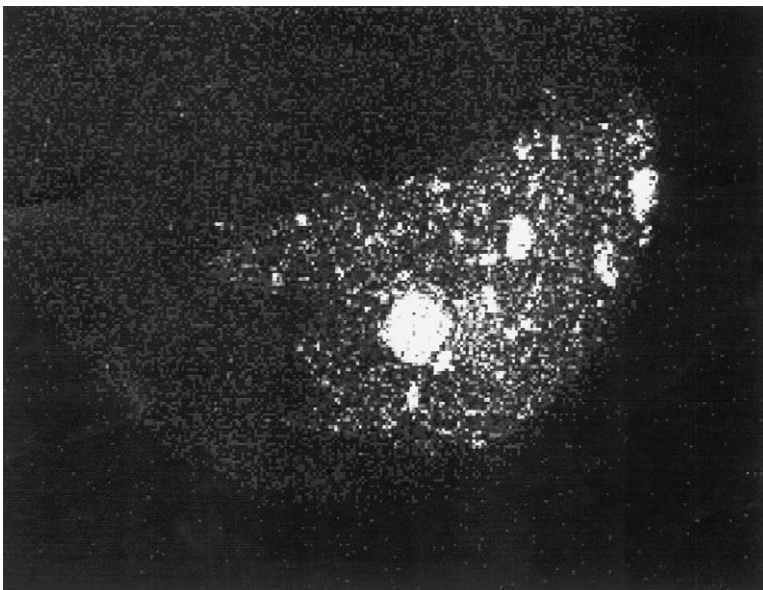

FIGURE 2 Chlorine mapping of a granulation containing a hydrochloride salt API.

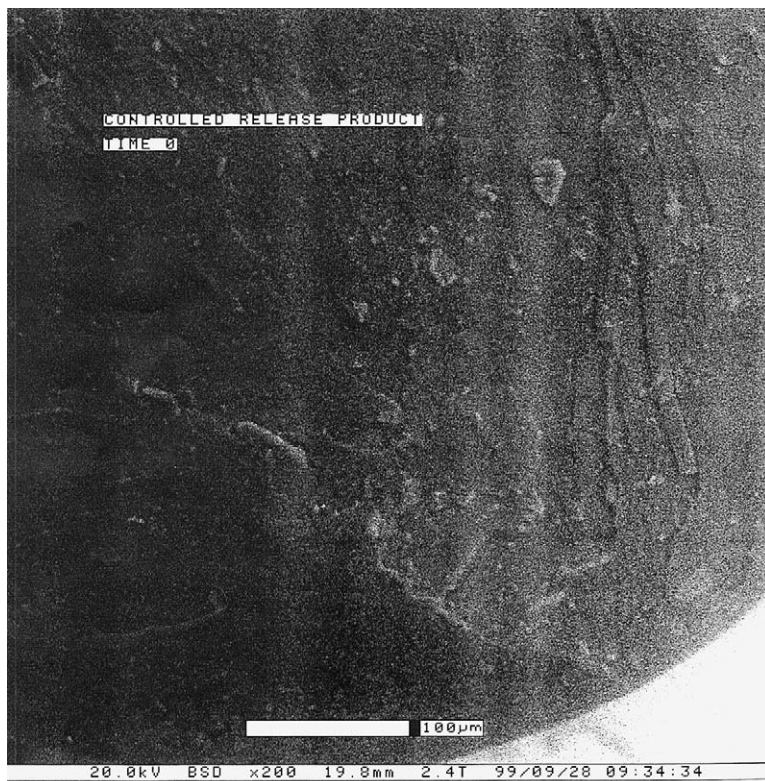

FIGURE 3 Scanning electron micrograph of a pellet at time zero of a dissolution.

granulation and retains its original particle size distribution; therefore, the high temperatures and drying conditions used in the manufacturing process do not appear to have negatively affected the drug substance.

Recently the author and his colleague were granted a patent¹⁶ for a microdissolution stage that is used within an SEM and allows real-time observation of a particle, tablet, or other solid during a dissolution test. This microdissolution stage allows an analyst to repeatedly acquire a scanning electron micrograph from the same location on the sample at different times. The microdissolution stage was used to analyze a pellet before and after a 1-hour dissolution test by SEM in the secondary and backscatter electron imaging modes (Figs. 3 and 4). These images show that after 1 h the API crystals on the surface of the pellet have dissolved (black holes). Nearly 100% of the API was released from the surface of these pellets during the experiment without any disintegration or dissolution of the matrix. Such surface morphology and topographical information provides insights that guide formulation development.

B. X-Ray Powder Diffraction

The molecules in a crystalline compound are ordered in a three-dimensional array called a lattice. When a collimated beam of X-rays is incident upon

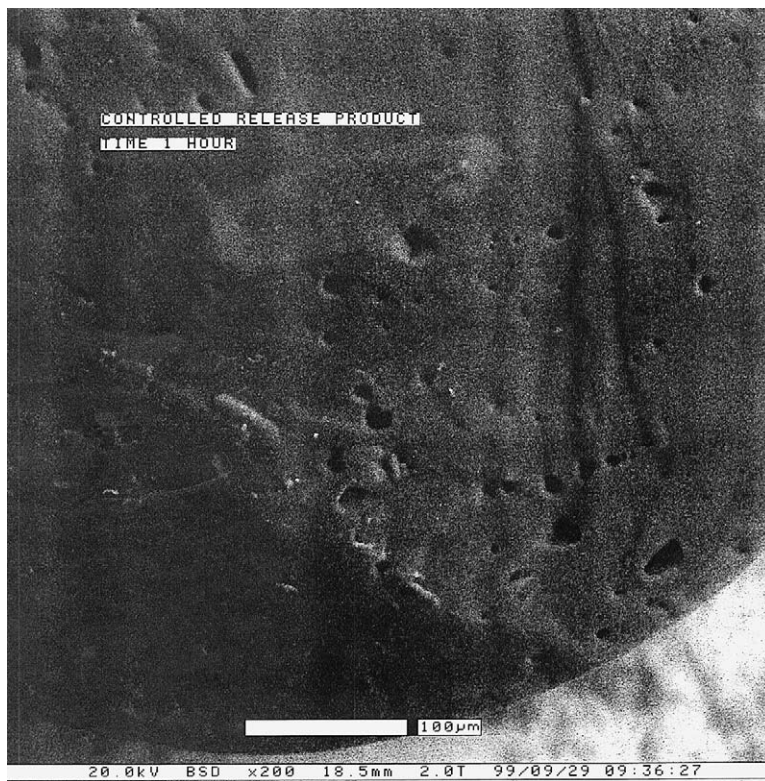

FIGURE 4 Scanning electron micrograph of a pellet after 1 hour of dissolution.

this lattice, X-rays are diffracted. Every crystal form of a compound produces its own characteristic X-ray diffraction pattern. This technique is useful for distinguishing between solid-state forms of a bulk drug substance and for characterizing changes in the solid state (e.g., distinguishing between polymorphs, hydrates, and solvates and characterizing phase transitions between them). The technique is also useful for characterizing changes in the drug substance in a solid state as it exists in a matrix of a formulation—for example, a change from a crystalline to an amorphous form or hydration, dehydration, etc.

A regulatory agency asked whether the polymorphic form of an API changed during the formulation process. To answer this question, X-ray powder diffraction patterns of crushed tablets, crushed placebo tablets, and three lots of the API were acquired (Fig. 5).

As seen in the diffraction patterns, the crystal structure of the API remained unchanged during processing. The peak positions exhibited in the X-ray powder diffraction pattern of the finished product (pattern 1) show good agreement with the peak positions exhibited in the powder diffraction patterns of the API (patterns 3–5) at high 2θ . Peaks contributed from the placebo (pattern 2) were minimal. The slight differences in X-ray powder diffraction patterns of the API (patterns 3–5) were attributed to preferential orientation of

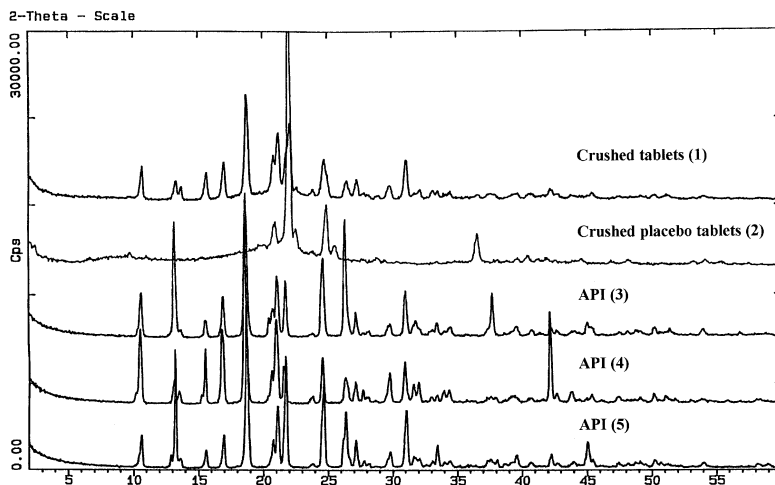

FIGURE 5 X-ray powder diffraction patterns of crushed tablets (pattern 1), crushed placebo tablets (pattern 2), and three lots of the API (patterns 3–5).

the crystals. This study revealed no obvious evidence of polymorphic changes of the API due to the manufacturing process.

C. Thermal Analyses

Simultaneous thermogravimetric and differential thermal analysis (TG/DTA) is a useful technique for the solid-state characterization of pharmaceutical materials. Such characterization includes the determinations of loss on drying, phase transition temperatures, thermal stability, and whether or not water is bound or unbound. TG/DTA combines the measurement of a change in mass of a sample as a function of temperature (TG) with the temperature difference of a sample compared with an inert reference material as a function of temperature (DTA).

The TG/DTA data are derived from the response of the sample to a heating program. In DTA the sample temperature remains constant throughout an endothermic transition, whereas the sample temperature increases during an exothermic transition. A TG curve is simultaneously acquired, yielding the corresponding mass change curve. These dual pieces of information make interpretations more straightforward than interpretation with either technique alone.

TG/DTA was utilized to monitor changes in the crystal morphology and physical changes of a hydrated API in a granulation blend and in tablets compressed from the blend. The TG/DTA thermograms are shown in Figures 6 and 7, respectively.

The DTA thermogram (solid line) for the granulation shows endotherms at 71.5°C and 110.8°C, which were determined to be due respectively to dehydration and melting of the API. The two endotherms at 60.6°C and around 100°C were determined to be due to the other matrix components. In the

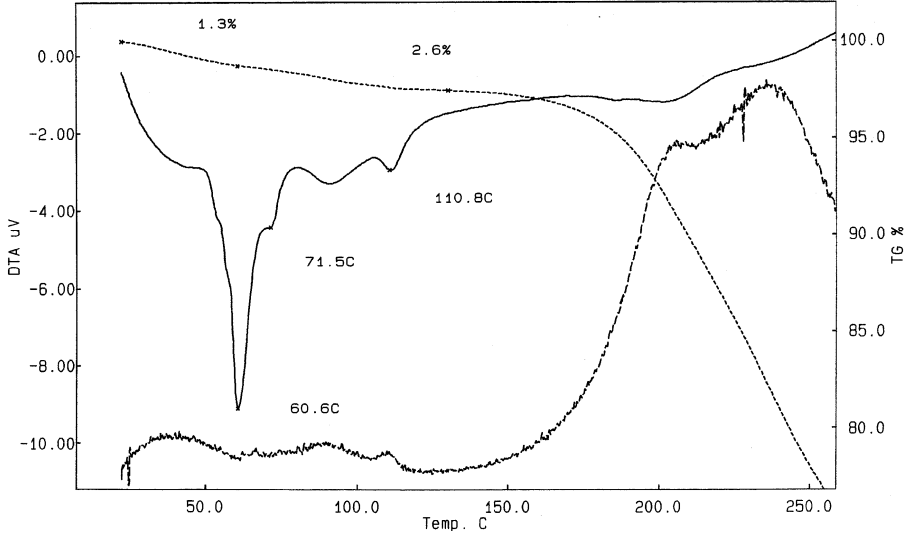

FIGURE 6 Thermogravimetric and differential thermal analysis results from a granulation blend of a hydrated API. The thermogravimetric curve is dotted; the differential thermal analysis curve is solid; the derivative of the thermogravimetric curve is dashed.

DTA thermogram of the tablet, the peak at 71 °C is absent, and the melting endotherm at 110.5 °C has broadened significantly.

The TG thermogram (dotted line) and the derivative of the TG thermogram (dashed line) for the granulation and tablet show the differences in the

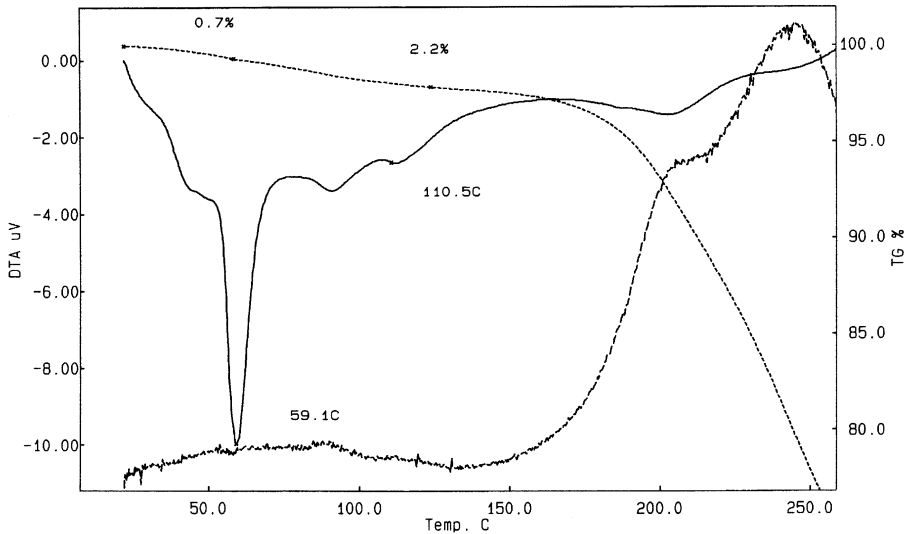

FIGURE 7 Thermogravimetric and differential thermal analysis results from a tablet of a hydrated API. The thermogravimetric curve is dotted; the differential thermal analysis curve is solid; the derivative of the thermogravimetric curve is dashed.

distribution of water. TG derivative thermograms are useful for distinguishing subtle transitions. Two distinct weight-loss steps can be seen in the granulation, whereas the tablet loses water continuously from ambient temperature to approximately 125 °C.

The results of the TG/DTA analyses show that the API in the tablet has lost bound water. These results, combined with results from X-ray diffraction (not shown), demonstrate that during tablet processing, the API changed some of its crystalline phase. If a portion of the API were to exist in an amorphous form, an increased rate of chemical decomposition might be expected. This study illustrates the importance of monitoring any changes in crystal form of the API due to processing into a finished dosage form.

D. FTIR Microspectroscopy

Infrared spectroscopy is well established, and infrared spectra are considered to be definitive for identity testing in the pharmaceutical industry. FTIR microspectroscopy, equipped with an automated stage, is a nondestructive technique that can be utilized to analyze small samples and to chemically map locations by identifying components within the sample. When unidentified crystalline particles were found growing on tablets during a stability study, FTIR microspectroscopy with a spectral resolution of about 5 μm was used to chemically analyze and identify the minute particles.

A micrograph of the excised crystals is shown in Figure 8, and the corresponding FTIR spectrum is presented in Figure 9. The spectrum of these

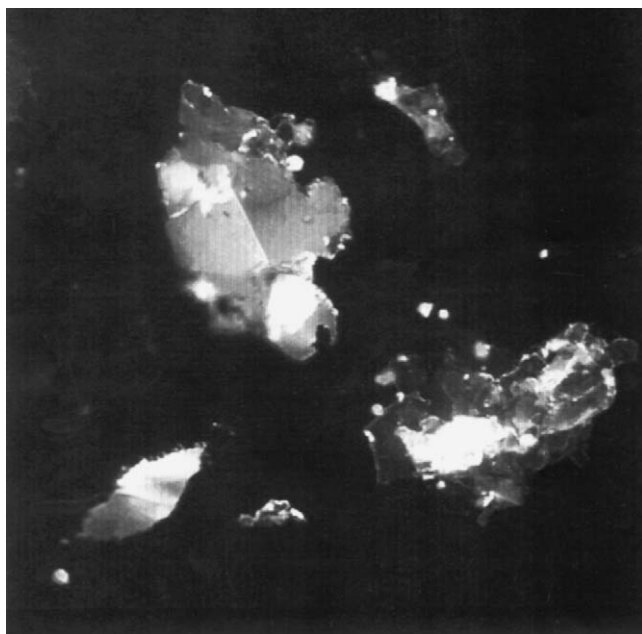

FIGURE 8 Micrograph of excised crystals found on tablets during a stability study.

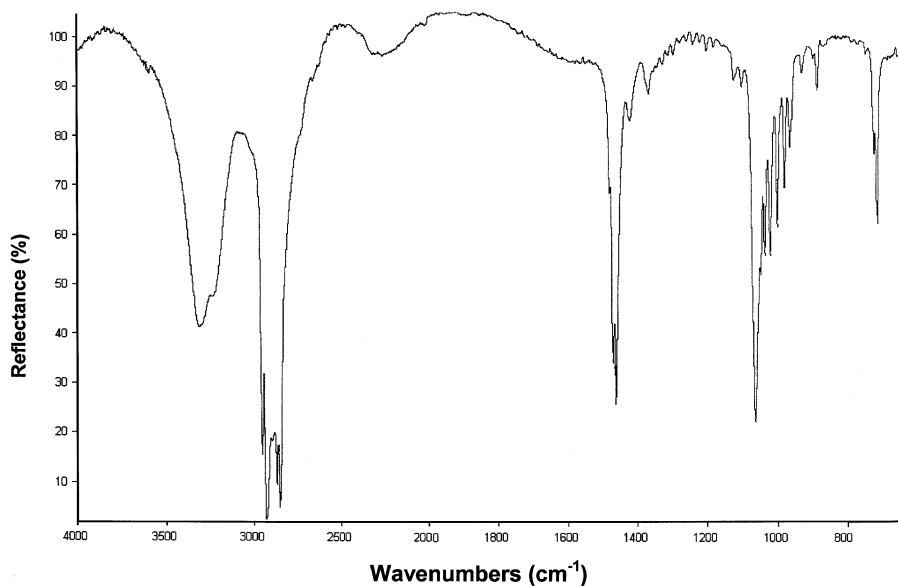

FIGURE 9 FTIR spectrum of excised crystals found on tablets during a stability study. The crystals were identified as stearyl alcohol.

crystals clearly identifies them as stearyl alcohol, one of the excipients in the formulation. As a result of this experiment, the tablet-coating process was modified.

E. NMR Spectroscopy

I. NMR Imaging

Understanding structural changes that occur in controlled-release dosage forms as they interact with physiological fluids is critical to understanding and predicting the performance of the product. As a result, noninvasive NMR imaging techniques have gained momentum in studies assessing the performance of solid oral dosage forms. One such study is of hydroxypropyl methylcellulose (HPMC) tablets that form a gel layer when the polymer matrix hydrates and swells. In an effort to understand the release of an API from controlled-release tablets containing HPMC, NMR imaging techniques were used to measure the relaxation times and self-diffusion coefficients (SDCs) of water across the gel layer.¹⁷ NMR imaging was performed with a standard half Fourier spin-warp sequence with a nonselective 180° radio frequency pulse.

For hydrophilic matrices, previous models proposed for water mobility assumed a constant water diffusion coefficient. In this study, the SDC values were found to increase with increasing distance from the gel region to the core of the tablet (Fig. 10).¹⁷ The SDC gradients (the change in SDC value over distance) were found to vary among HPMC tablets with different levels of polymer substitution. This type of *in vitro* NMR imaging experiment can provide important information to guide formulation optimization and aid in the design of drug products that deliver the desired *in vivo* release characteristics.

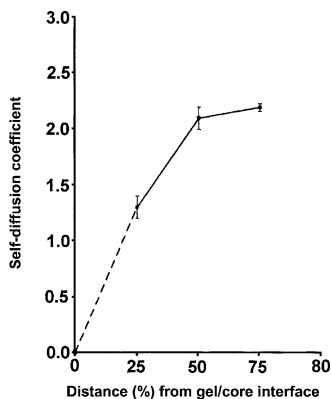

FIGURE 10 Self-diffusion coefficients of water across the gel layer of an HPMC tablet after 3 hours of hydration. The x axis is as shown in the original. (Reprinted with permission from ref. 17, Copyright 1996, Plenum.)

In another study, NMR imaging with a modified flow-through dissolution apparatus was used to assess the swelling of HPMC tablets.¹⁸ The series of images reproduced in Figure 11 show the physical changes in HPMC tablets

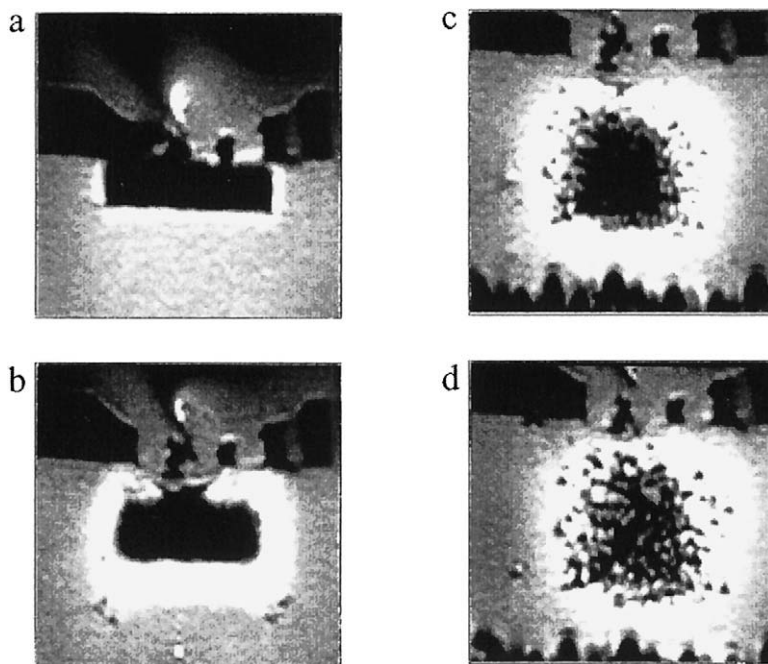

FIGURE 11 NMR images of HPMC tablets within a flow-through dissolution apparatus under static conditions at swelling times of 1, 5, 13, and 19 hours (a–d, respectively). The black center regions show where the tablet is dry, and the bright regions around the tablet show where the gel is swollen. (Reprinted with permission from ref. 18, Copyright 2000, Elsevier.)

over time under static conditions. Determining the swelling behavior of the HPMC with this type of imaging may increase the understanding of the release of the API from the dosage form. This approach was successfully applied to the study of matrix-controlled-release tablets as well as osmotic-release tablets. NMR imaging techniques are complementary to standard USP-type dissolution studies and provide information about the nature of the physical processes involved in the disintegration and dissolution of the drug product.

2. Solid-State NMR

Solid-state NMR studies have been used to study the characteristics of an API in melt-extruded pellets. The purpose of the study was to determine whether the high temperatures at which the melt extrusion process was conducted caused physical changes in the drug substance, such as the formation of a different polymorph or a change in salt form. Proton-enhanced ^{13}C solid-state NMR spectra were obtained with an NMR spectrometer equipped with a multinuclear magic-angle spinning (MAS) probe with high-power proton decoupling and cross-polarization (CP). A ^{13}C pulse sequence with proton decoupling was employed to obtain the ^{13}C CP/MAS spectra.

The spectra obtained from the final dosage pellets, the hydrochloride salt of the drug substance, and the free base of the drug substance are presented in Figure 12. The regions of the spectrum where there is no interference from the placebo matrix responses are shown in the figure. From the response pat-

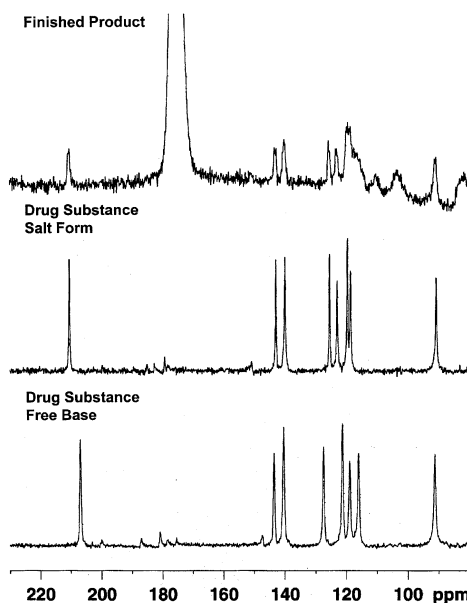

FIGURE 12 Proton-enhanced ^{13}C CP/MAS solid-state NMR spectra of a melt-extruded drug product (top), the salt form of the drug substance (middle), and the free-base form of the drug substance (bottom). The spectra were obtained with an NMR spectrometer equipped with a multinuclear magic-angle spinning (MAS) probe with high-power proton decoupling and cross-polarization (CP). A ^{13}C pulse sequence with proton decoupling was employed to obtain the ^{13}C CP/MAS spectra.

terns in the 115–128 ppm and 208–210 ppm regions, it is evident that the drug substance survived the manufacturing process as the original salt form. In addition, the spectra do not indicate any other apparent differences in physical forms of the drug substance.

F. Mass Spectrometry

Mass spectrometry (MS) is one of the most specific techniques available to the analytical chemist because the generation of molecular weight data coupled with fragmentation patterns is usually quite conclusive. The use of MSⁿ often allows complete specificity, even in the presence of related substances, impurities, and pharmaceutical matrices.^{19–21}

Recently, time-of-flight MS combined with secondary-ion monitoring (TOF-SIMS) has been reported to be a useful tool for characterizing and imaging the distribution of the components within a solid dosage form.^{22, 23} A pellet consisting of a ~100- μm -wide silica core, a ~100- μm -wide metoprolol drug layer, and a ~50- μm -wide outer coating of ethyl cellulose was cross-sectioned and bombarded with a 15-keV Ga⁺ ion source, and the mass spectra obtained from the regions of interest provided information about the distribution of the various components.²² The resulting image for the metoprolol molecular species (268 Da) reveals the absence of drug in the inner and outer layers of the pellet (Fig. 13).

This technique could be extremely important for assessing the controlled-release properties of a solid oral dosage form. The homogeneity and quality of the manufacturing process could be determined. Also, this technique could be applied to the analysis of the surface of beads, tablets, and granulations, allowing the chemical composition of more than one layer to be evaluated.

G. Raman Spectroscopy

Advancements in dispersive Raman spectroscopy, including improvements in detectors, filters, optical fibers, and instrument designs,²⁴ have made this tech-

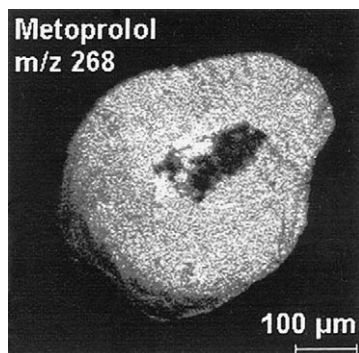

FIGURE 13 TOF-SIMS imaging of a silica core (dark area in center), a metoprolol drug layer (goldish color), and an ethyl cellulose outer coating. The image is at mass 268 Da and illustrates the absence of drug in the inner and outer layers. (Reprinted with permission from ref. 22, Copyright 2000, Elsevier.)

nique a readily accessible tool for the *in situ* and noninvasive determination of solid-phase physical properties of the API in solid dosage forms. In addition, the relatively low-energy light near the visible region lends itself well to the use of optical fibers, and Raman spectroscopy does not require any sample preparation. A spatial resolution of approximately 2 μm is possible.

Laser-source confocal Raman spectroscopy was used to analyze solid dispersions to evaluate the physical properties and determine the distribution of ibuprofen in extrudates of polyvinylpyrrolidone (PVP).²⁵ As is shown in Figure 14, a shift in the Raman spectra occurs when the crystalline form of ibuprofen is compared to a solution or a PVP extrudate containing ibuprofen. For comparison purposes, ibuprofen was completely dissolved in dimeric 1,3-bis (pyrrolidonyl) butane, a PVP-like solvent, to determine if the state of ibuprofen in the extrudate was equivalent to that in the solution. It was shown that the ibuprofen exists as a noncrystalline form (a solid solution) within the matrix; powder X-ray diffractometry and differential scanning calorimetry confirmed this finding.

The lack of any further Raman shifts during a stability study indicated that the ibuprofen in the melt extrudate is stable and that there were no crystallization processes that could affect the dissolution and bioavailability. Therefore, one use of confocal Raman spectroscopy could be to optimize various formulations and quickly determine their likely long-term stability.

The relative signal intensity of the Raman shift was also found to be proportional to HPLC assay results.²⁵ With the use of confocal Raman spectroscopy, the ibuprofen distribution in the extrudate was mapped; therefore, this technique can be used to measure homogeneity (blend uniformity) in a fast and nondestructive manner.

III. NEAR-INFRARED ANALYSIS

There is intense interest in using NIR techniques in several major areas of pharmaceutical operations: clinical supply identification, incoming raw material

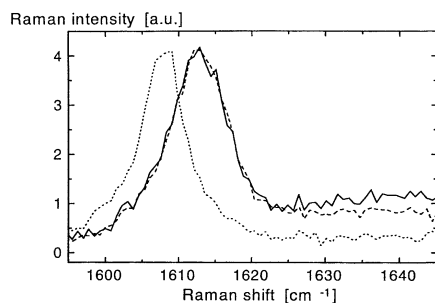

FIGURE 14 Raman spectra of three ibuprofen formulations. Ibuprofen formulations: solution (dimer 3), solid line; extrudate (PVP), dashed line; crystalline powder, dotted line. The ibuprofen extrudate and solution are shifted compared to the crystalline form of ibuprofen. (Reprinted with permission from ref. 25, Copyright 1999, Plenum.)

identification, and assay and content uniformity testing of finished products. Early research demonstrated the feasibility of using this technique for the analysis of pharmaceutical powders and solid dosage forms.^{26,27} Since then two major advances have occurred. The first was the development of suitable instrumentation enabling NIR transmission analysis. The development of the transmission instrument is significant because it overcomes the signal-to-noise limitations of the reflectance mode. The second advance was the development and publication of guidelines for validating analytical methods used in the pharmaceutical analytical laboratory.^{28,29}

The ICH validation guidelines^{28,29} provided a starting point for the development of NIR methods for the analysis of pharmaceutical products. The first attempt to validate an NIR method with the use of ICH guidelines was published in 1998.³⁰ Subsequent work resulted in another validation scheme that was presented at the Spectroscopy in Process and Quality Control Conference in 1999.³¹ The unique aspect of the latter approach was that all of the currently published guidelines^{28,29,32–35} were unified into one protocol for the validation of an NIR method to comply with current Good Manufacturing Practices (cGMP) guidelines.

The following sections describe qualitative and quantitative examples of validated NIR methods currently in use.

A. Qualitative NIR Analysis

I. Verification of the Identity of Packaged Clinical Supplies

NIR analysis is particularly suited to the verification of the identity of packaged clinical supplies because of its nondestructive nature, speed, and low cost. Because every clinical study is a unique event consisting of a finite population of dosage forms, models can easily be generated and validated, and the final-blinded products can be tested the same day that the analysis request is made.

An NIR spectroscopic method to identify pharmaceutically active and inactive (placebo) clinical dosage forms was recently developed.³⁶ Typically, the dosage form is packaged with its placebo in the same blister pack. The purpose of the NIR identification method was to identify, nondestructively and rapidly, the four forms in the blister pack. The method was developed to create and validate a one-time-use library of the spectra of clinical dosage forms prepared for double-blind clinical trials.

A novel approach was used to generate and validate the library simultaneously. Inasmuch as specific lots of active and placebo dosage forms were packaged for a particular study, samples from these lots were used to create the library. The library was created from half of the samples and validated with the use of the remaining half of the samples. Figures 15 and 16 illustrate the NIR spectra and the results of the principal component analysis. These results, NIR spectra in Figure 15 and distinct clusters in Figure 16, show that NIR can distinguish between active and placebo tablets.

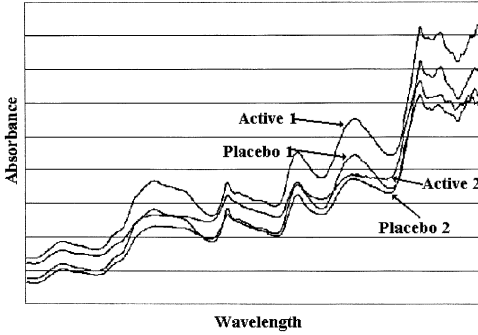

FIGURE 15 NIR spectra of known active and placebo (inactive) products packaged into blister cards. Spectra were obtained through the blister.

2. Raw Material Identification

Currently, the primary use of NIR for pharmaceutical analysis is in the identification of raw materials. Some regulatory agencies have mandated that 100% of the materials to be released for use should be verified, rather than the use of traditional statistical sampling, before the materials are mixed and compounded in production. If NIR is utilized to comply with this mandate, a 1997 European Pharmacopoeia monograph, which specifies the minimum standards for an NIR identification method, should be consulted.³²

The overall approach to raw-material verification is similar to the identification of blinded packaged clinical supplies described in the previous section. The difference in using the technique for raw material identification is that the library is composed of spectra from dozens of lots that are averaged into a single spectrum for each raw material. The spectral variations from an average spectrum of a raw material represent the variation that may be encountered in the future. The library is dynamic, as it can be updated to incorporate new raw materials, raw materials whose physical characteristics have changed, or phased-out raw materials that are no longer used in the manufacturing process. Constructing a library composed of mean spectra and their variances allows many different compounds to be stored, and the spectrum of an unknown

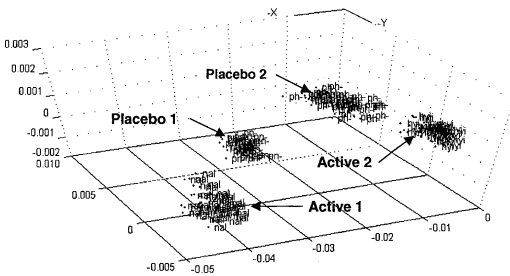

FIGURE 16 Principal component analysis (PCA) of the transformed spectra can be viewed as a three-dimensional scores plot. The data from each active and placebo dosage form fall into a separate cluster.

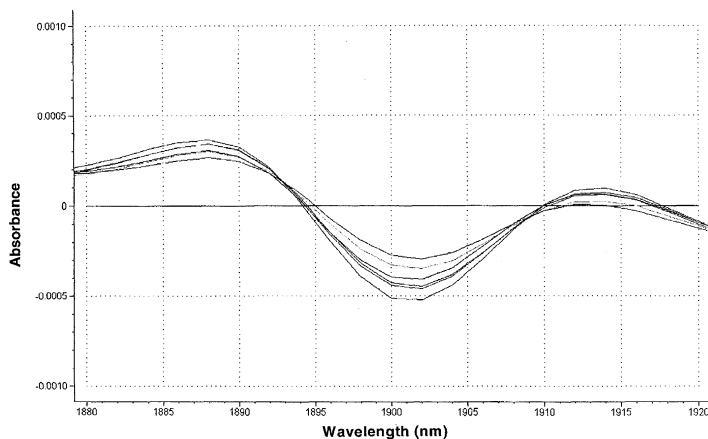

FIGURE 17 NIR spectra at high, middle, and low positions of a V-blender after 1 minute of mixing.

material is matched against all possible similar compounds. The unknown is either accepted or rejected based upon how close (within accepted variations) its spectrum matches that of a known compound.

3. Blend Homogeneity

In one study, the homogeneity of pharmaceutical raw materials during blending was followed by visual matching, spectral matching, or principal component analysis of the spectra after discrete time intervals.³⁷

In another study, the feasibility of the use of NIR spectroscopy at-line during production to control product quality was examined.³⁸ NIR spectra obtained after different mixing intervals were used to assess the extent to which four components were blended in a V-blender. NIR reflectance spectra were collected with the use of a fiber-optic probe at “high,” “middle,” and “low”

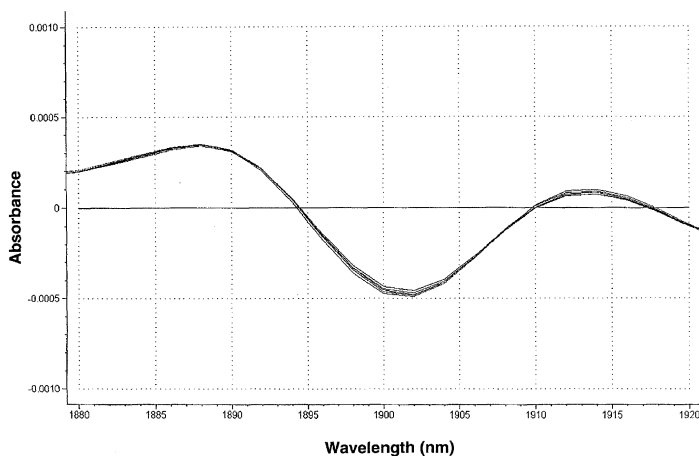

FIGURE 18 NIR spectra at high, middle, and low positions of a V-blender after 20 minutes of mixing.

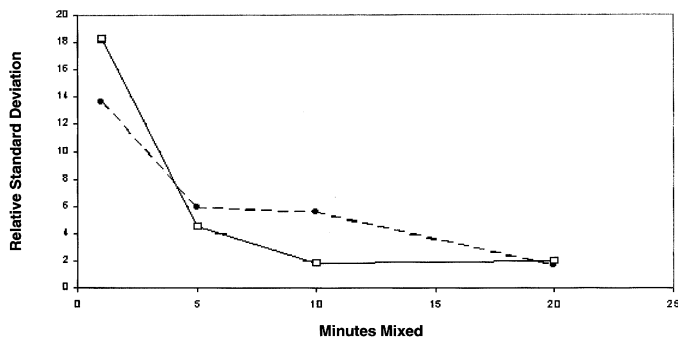

FIGURE 19 RSDs of the NIR results at 1904 nm (square) at several mixing time points compared with the RSDs from the HPLC assay results (circle) at the same mixing times, excluding the 15-minute interval.

positions on the blender at 1, 5, 10, 15, and 20-minute intervals. Spectra of the four-component blend after 1 minute and 20 minutes of mixing are illustrated in Figures 17 and 18, respectively.

At each interval, the relative standard deviation (RSD) of the NIR results at a wavelength specific to the active component was calculated. In addition, parallel HPLC analysis of the blend was performed. To show that the NIR method is comparable to results obtained by analysis by HPLC, the RSDs of the NIR results and the RSDs obtained from the HPLC assay results were plotted versus minutes mixed (Fig. 19). This experiment shows the feasibility of using NIR to determine the blend homogeneity of both API and excipients simultaneously in real time, thus ensuring optimal content uniformity during compression or capsule filling.

B. Quantitative NIR Analysis

The need for both automation and high-speed analysis in the analytical laboratory has already been addressed. One technique that seems to combine the best of both is NIR analysis. Once an NIR assay is validated, an analyst can generate single-unit analyses usually in less than 1 minute per sample. In a single morning, dozens (possibly hundreds) of single-unit analyses can be performed and reported.

The use of American Society for Testing and Materials (ASTM) standards was proposed to assist in the validation of NIR spectroscopic methods.^{39, 40} Currently, there are no existing regulatory guidelines for validating a NIR method. The ICH validation guidelines for analytical methods^{28, 29} and other compendial guidelines^{32, 33} were integrated with ASTM standards^{34, 35} to satisfy GMP regulations and validate a quantitative NIR transmission assay for tablets.⁴¹ Interestingly, another study⁴² included data on a validated NIR transmission content uniformity method for capsules at the same conference. What is significant about these studies is that they independently arrived at the same conclusions regarding their approach for validating NIR methods for the analysis of pharmaceutical products.

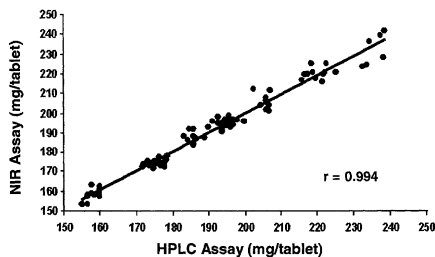

FIGURE 20 Correlation between NIR and HPLC (reference method) assay results.

NIR methods can be validated by the conventional protocols described in ICH and other regulatory guidelines as they are currently written; however, some modifications have to be made to account for differences between spectrophotometric and chromatographic experimental parameters. For example, spiked recovery experiments are not relevant because NIR responses are sensitive to the production process. The criteria suggested for validating a NIR transmission method include⁴¹

Specificity	Principal component analysis (PCA) for identification
Accuracy	Residual analysis, difference of the estimated (NIR) value from the reference value, from ASTM Standard E 1655
Precision	Repeatability and reproducibility, from ICH guideline
Linearity	Durbin-Watson statistic, evaluated for sequential dependence of the residuals in which each error is correlated with those before and after it in the sequence when the data are put in order of their NIR predicted values
T test for the slope	Determines whether there is a significant difference between the actual slope of the calibration set and the theoretical slope of one
Range	80–120% of the nominal concentration for assay and 70–130% of the nominal concentration for content uniformity testing, ICH guideline
Robustness	F for regression test

To validate the method in the range of 80–120% of label claim, actual production samples were used in addition to development batches that were prepared to extend the validation range.⁴¹ Excellent correlation ($r = 0.994$) between NIR and HPLC results is shown (Fig. 20) in the calibration regression plot derived from a multiple linear regression equation using four wavelengths. Once an NIR method is validated, the scanning of the tablets and calculation of the results require less than 1 minute. Thus, it becomes practical to assay hundreds of finished units from a batch throughout a production run instead of selecting a few samples on a small, randomized sampling protocol.

IV. AUTOMATION

A. Fiber-Optic Dissolution System

IVIVC studies are expected for NDAs for solid oral extended-release dosage forms. Regulatory agencies have an expectation that *in vitro* release (disso-

lution) testing should be used as more than a quality control test. SUPAC guidelines as well as guidance on extended-release dosage forms have placed an increasing emphasis on the dissolution test.¹⁵ If an IVIVC has been demonstrated, SUPAC enables sponsors to make site, process, raw material source, and other changes in marketed products without expensive *in vivo* studies if the resulting dissolution profiles are shown to be equivalent.

The dissolution test has been a labor- and resource-intensive test in need of modernization. In general, for controlled-release products, 6 or 12 dissolution vessels are sampled periodically throughout a time period of up to 24 hours or more. Increasingly, dissolution profiles are expected for immediate-release products as well. For the determination of IVIVCs the *in vitro* time periods ideally should correspond to the times of the *in vivo* measurements. The *in vivo* measurements may be every 10 or 15 minutes over the early course of a study and every half-hour thereafter. The corresponding *in vitro* measurements are not practical with conventional apparatus currently described in the compendia.

In addition, the use of sippers, transfer tubing, and injectors (manual or otherwise) is not practical or reliable enough for these data collection rates. The complex equipment contains numerous moving parts that can malfunction and cause sampling errors. In addition, these systems are prone to dilution-related errors, contamination, sample carryover, leaks, and blockage by air bubbles and particulate matter.

Fortunately, automated fiber-optic probe-based dissolution systems have begun to appear for these solid dosage-form applications.^{43–49} One such system uses dip-type UV transmittance fiber-optic probes, each coupled to a miniature photodiode array (PDA) spectrophotometer to measure drug release in real time.⁵⁰ This fiber-optic dissolution system can analyze immediate- and controlled-release formulations. The system is more accurate and precise than conventional dissolution test systems, and it is easier to set up than conventional manual sampling or automated sipper-sampling systems with analysis by spectrophotometry or HPLC.

The computer-controlled system acquires raw spectral data within the range of 200–400 nm at specified time intervals, calculates the results with the use of validated software, and stores the data in a secured computer database. Except for the dissolution apparatus itself, the system contains no moving parts. The spectral data can be corrected for turbidity-related scatter with the use of either a simple baseline subtraction or a second-derivative-based algorithm, and test results and/or profiles can be viewed in real time.

With the use of an *in situ* fiber-optic dissolution system, the dissolution profile of commercially available buffered aspirin tablets was obtained and compared with that obtained by manually withdrawing aliquots of sample and measuring the amount dissolved by a reference HPLC method. The dissolution profiles (Fig. 21) demonstrated that *in situ* measurements made with the fiber-optic dissolution system are as accurate as those obtained with the reference method. In addition, the *in situ* measurements were obtained every 30 seconds, demonstrating that detailed dissolution profiles of immediate-release dosage forms can be obtained with ease. Although regulatory guidelines generally require evaluation of solid immediate-release dosage forms at 45 minutes,

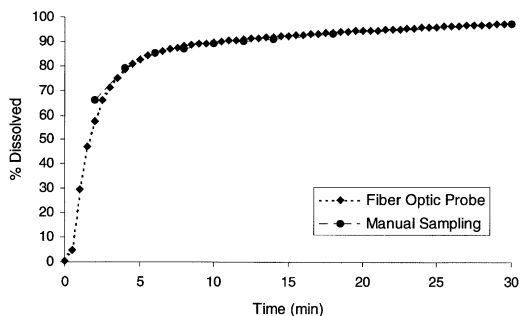

FIGURE 21 Dissolution profiles for buffered aspirin tablets obtained with the fiber-optic dissolution system (260–350 nm) and manual sampling with HPLC analysis. The dissolution was performed with USP apparatus 2 at 75 revolutions per minute. A second-derivative baseline correction was performed on the fiber-optic raw spectral data to correct for scattering due to the turbid solution.

competitive brands may be easily distinguished if their early release profiles are different.

For 12-hour controlled-release tablets, the accuracy of the 12-hour dissolution profile obtained from *in situ* measurements was assessed by comparison with measurements obtained by manual withdrawal and analysis by HPLC. The results (Fig. 22) obtained by two analysts on different days show that the 12-hour dissolution profile obtained from *in situ* fiber-optic-probe-based measurements is as accurate as that obtained by the automated withdrawal of the sample and analysis by HPLC. In addition, *in situ* measurements were obtained with fiber-optic probes placed in the medium at the USP sampling position throughout the test, whereas the cannulas used to manually withdraw medium were inserted and removed at each measurement interval. The fiber-optic dissolution system displays excellent stability and validation char-

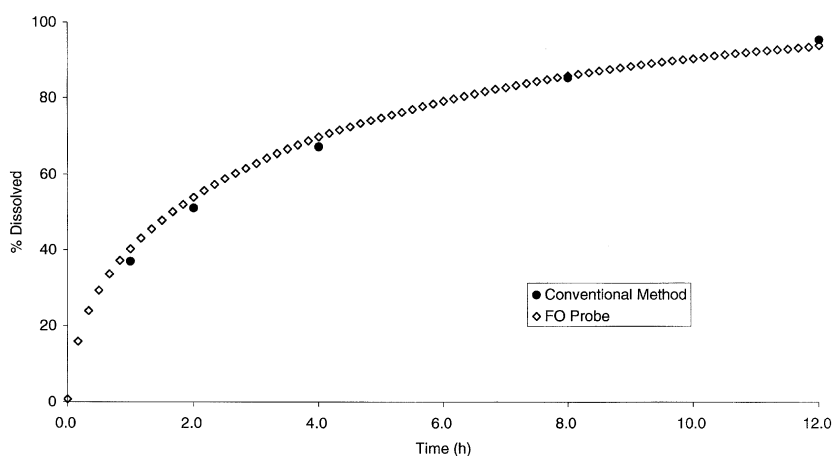

FIGURE 22 Comparison of dissolution profiles obtained by fiber-optic dissolution system and conventional method for 12-hour controlled-release tablets. The dissolution was performed with USP apparatus 2 at 100 revolutions per minute.

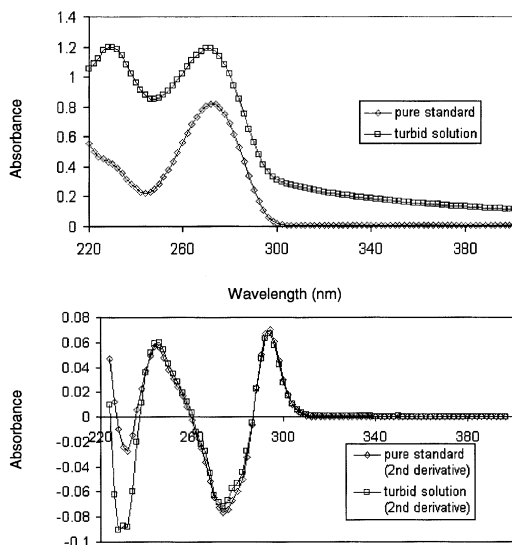

FIGURE 23 Comparison of absorbance spectra for baseline (top) and second-derivative (bottom) scattering corrections for a pure caffeine standard solution and a turbid caffeine solution.

acteristics. The amount dissolved is calculated on an almost continuous basis and is ideal for IVIVC purposes and as an aid to choosing the most meaningful dissolution specification time points.

The fiber-optic dissolution system is capable of supplying an identity determination, even in the presence of turbid excipients. The second-derivative scattering correction is shown in detail in Figure 23. In this figure, the baseline-corrected UV absorbance spectra of pure and turbid caffeine solutions (top) are compared with the second-derivative scattering-corrected spectra of these same solutions (bottom). The bottom portion of the figure shows that the second-derivative algorithm removes the sloping baseline and corrects for scattering.

In addition to the dissolution and identification tests, the ability of the system to perform an assay and a content uniformity determination has been demonstrated. Because there are no fluid transfers, the vessels can be sealed, eliminating the need for volume corrections or fluid replacements. Therefore, with a 12-vessel dissolution apparatus, it is possible to designate 10 of the vessels for the content uniformity test and to average the results from the 10 or 12 vessels for the assay determination. Typical data for a 12-hour controlled-release product are presented in Table 2. Excellent agreement between the fiber-optic- and HPLC-based measurements is evident.

This fiber-optic dissolution technology represents a considerable breakthrough for the quality control laboratory. It is as accurate and precise as conventional dissolution test measurements and is easy to set up. By combining four tests (dissolution, identity, assay, and content uniformity), which commonly demand 3–4 days of analyst time, the technique requires about half a day of analyst time, and data acquisition is secure, automatic, and archiv-

TABLE 2 Comparison of Fiber-Optic and HPLC Results for Content Uniformity

Capcule	Percentage drug substance by two methods	
	HPLC	Fiber-optic
1	104	103
2	100	102
3	104	102
4	98	106
5	102	97
6	105	107
7	104	104
8	104	105
9	104	98
10	99	102
Average	102	103
Relative standard deviation	2.4%	3.1%

able. Techniques of this kind should allow a greater body of high-quality data to be acquired and result in better batch quality assessment.

B. Flow Injection Analysis

As previously discussed, the ICH Quality Guidance Q6A states that synthesis impurities of the API are not required to be remeasured in the dosage form unless they degrade during the manufacturing process. This paves the way for the use of automated high-throughput techniques, such as FIA, that are capable of up to 100 analyses per hour or more.

FIA systems capable of analyzing tablets are described in the literature. This often includes spectrophotometric-based detection, where there is little background interference.^{51,52} Where there is significant interference from excipients, many applications employ some sort of column solid-phase clean-up such as ion exchange or on-line solvent extraction.^{53–58} Chemiluminescence resulting from the complexation with metal ions,^{59–62} redox reagents,⁶³ or derivatizations with organic substrates^{64–68} are commonly used to avoid matrix effects. Electrochemical detectors such as polarography,⁶⁹ amperometry,⁷⁰ and potentiometry^{71,72} are described to provide added specificity. Fluorescence applications have also been reported.^{73–77}

With FIA, high sample throughputs are achievable with good results. The development of a system with good linear response capable of analyzing 40 paracetamol tablets per hour was reported.⁵³ In another application, 65 aspirin tablets per hour were analyzed with a repeatability of about 0.4%.⁵¹

C. Robotics and Laboratory Automation

To acquire the huge amounts of data required for pharmaceutical registrations, automated techniques have been developed and continuously improved over the past several decades. An early autoanalyzer technique employed continuous solution flow streams separated by air bubbles, and highly successful commercial systems were developed based upon this technique.⁷⁸ In recent years, however, these systems have fallen out of favor because of their complexity and high maintenance requirements.

Over the last 30 years, robotic systems to automate manual laboratory techniques have become available. More recently, robotic systems have evolved that operate unattended and are capable of high-throughput solid dosage-form analysis with an accuracy and precision equivalent to their corresponding manual techniques. These systems initially suffered from faulty design, frequent breakdown, poor user interface, and complex programming requirements, but to a great extent, these faults have been overcome.^{79–83}

Almost all aspects of manual analyses have been automated, ranging from sample handling to measurement with automated calculation and report generation.^{84–96} These automated analyses have been applied to many types of tests, including assay, content uniformity, dissolution, and moisture, and are routinely used for product release and stability testing. Some companies have constructed complete robotic laboratories in a centralized or decentralized manner to generate tens of thousands of assay results per year.

V. FUTURE DIRECTIONS

In the past century, there has been a tremendous growth in pharmaceutical analyses and the role the analytical group plays in the development of new products. The baton was passed from techniques such as gravimetry, titrimetry, spectroscopy after extraction, and thin-layer paper chromatography to HPLC, gas chromatography, and various autoanalyzers. Emphasis was on tests such as assay, content and blend uniformity, and determination of impurities and residual solvents.

To produce affordable, quality medications, much of the routine test results will have to be produced by newer, high-throughput techniques that generate huge volumes of data without analyst intervention. Chemometrics and “expert” systems will play a major role in the treatment and interpretation of the data. The analyst will have more choices regarding the bench-top analytical techniques and will have to ensure that the most efficient and meaningful body of data is collected.⁹⁷ Devices such as the “lab on a chip” will become available for small molecules. They may be a long way off, but techniques analogous to NIR will evolve, probably enabling some sort of measurement on every dosage unit.

Pharmaceutical analysis needs more functionality tests for solid oral dosage forms. After all, we know and have a record of the amount of drug added to the batch. The industry needs to take advantage of the modernization of the techniques described within and routinely apply them to *in situ* analyses

to show that the batch was compounded correctly and that it will be efficacious. There are vast opportunities for advances in instrumental design and development, *in situ* measurement, and performance prediction. Such developments will continually provide opportunities for analytical chemists to increase the impact of their work.

VI. SUMMARY

The pharmaceutical analysis of finished solid oral dosage forms is presented here from the aspect of what makes the delivery form unique and successful, i.e., the physical properties and the state of the drug substance in the matrix. During product development, many analytical techniques can be brought to bear that provide a characterization of the product and guide the pathway to the optimum formula. In many cases, these techniques can be used to assess the effects of processing parameters and provide a means to predict the performance and stability of the final product.

Techniques that apply to *in situ* analysis of the dosage form, its precursor granulations, or powders are discussed. Applications of solid-state NMR, FTIR microspectroscopy, visual and scanning electron microscopy, Raman spectroscopy, NIR analysis, thermal techniques, mass spectrometry, and imaging techniques are presented.

A summary of new high-throughput applications of methodologies is also presented. Examples are fiber-optic dissolution technology, flow injection analysis, NIR analysis, and robotics. These techniques provide data with less analyst involvement and allow a more thorough batch quality assessment.

ACKNOWLEDGMENTS

The author is indebted to the following individuals for their technical assistance with this chapter: Gary Barbera, Kevin Bynum, Emil Ciurczak, Dr. Michael Dong, Jennifer Giordano, Abe Kassis, James Mitchell, Kelly Nesmith, Roy Paul, Gary Ritchie, Dale Roberts, Saji Thomas, Cindy Tso, Dr. Mieng-Hua Wann, Artur Wollocko, Dr. David Wu, and Leon Zhou. The author also thanks Stacy MacDonald and Ronnie Scherer for editorial help and Esther Cheng for library support.

REFERENCES

1. Dorsey, J. G., Cooper, W. T., Siles, B. A., and Barth, H. G. Liquid chromatography: theory and methodology. *Anal. Chem.* 70:591R-644R, 1998.
2. Gilpin, R. K. and Pachla, L. A. Pharmaceutical and related drugs. *Anal. Chem.* 71:217R-233R, 1999.
3. Krstulovic, A. M. and Lee, C. R. Defining drug purity through chromatographic and related methods: current status and perspectives. *J. Chrom. B.* 689(1):137-153, 1997.
4. Adamovics, J. A., Ed. *Chromatographic Analysis of Pharmaceuticals*, 2nd ed. Dekker, New York, 1996.

5. Riley, C. M. and Rosanke, T. W., Eds. *Development and Validation of Analytical Methods*. Elsevier Science, Amsterdam, 1996.
6. Weston, A. and Brown, P. R. *HPLC and CE: Principle and Practice*. Academic Press, San Diego, 1997.
7. Kelly, M. A., Clark, B. J., and Altria, K. D. Investigation into the effects of sample dissolving solvents and sample matrices on the separation obtained in capillary electrophoresis. *J. High Resol. Chromatogr.* 21:193–196, 1998.
8. Altria, K. D., Traylen, E., and Turner, N. Analysis of dissolution test sample solutions by high speed capillary electrophoresis. *Chromatographia* 41(7–8):393–397, 1995.
9. Altria, K. D. and Bestford, J. Main component assay of pharmaceuticals by capillary electrophoresis: considerations regarding precision, accuracy, and linearity data. *J. Cap. Elec.* 3(1):13–23, 1996.
10. D'Arcy, P. F. and Harron, D. W. G., Eds. *Proceedings of the First International Conference on Harmonisation*, Brussels, 1991. Queen's University of Belfast, Ireland, 1992.
11. D'Arcy, P. F. and Harron, D. W. G., Eds. *Proceedings of the Second International Conference on Harmonisation*, Orlando, 1993. Queen's University of Belfast, Ireland, 1994.
12. D'Arcy, P. F. and Harron, D. W. G., Eds. *Proceedings of the Third International Conference on Harmonisation*, Yokohama, 1995. Queen's University of Belfast, Ireland, 1996.
13. *International Conference on Harmonization*, Q6A. Available at <http://www.ifpma.org/ich1.html>.
14. Banes, D. *A Chemist's Guide to Regulatory Drug Analysis*. Association of Official Analytical Chemists, Washington, DC, 1974.
15. Available at <http://www.fda.gov/cder/guidance/index.htm>.
16. Mitchell, J. A. and Palermo, P. J. Dissolution stage for an environmental scanning electron microscope. U. S. application serial no. 09/316,862, WO 99/62097 (December 2, 1999), corresponding PCT application to the granted patent.
17. Rajabi-Siahboomi, A. R., Bowtell, R. W., Mansfield, P., Davies, M. C., and Melia, C. D. Structure and behavior in hydrophilic matrix sustained-release dosage forms: 4. Studies of water mobility and diffusion coefficients in the gel layer of HPMC tablets using NMR imaging. *Pharm. Res.* 13(3):376–377, 1996.
18. Fyfe, C. A., Grondey, H., Blazek-Welsh, A. I., Chopra, S. K., and Fahie, B. J. NMR imaging investigations of drug delivery devices using a flow-through USP dissolution apparatus. *J. Controlled Release* 68:73–83, 2000.
19. Lee, P. I. and Good, W. R., Eds. Surface chemical analysis of polymeric drug delivery systems by static secondary ion mass spectrometry (SSIMS) and SIMS imaging. In *American Chemical Society Symposium Series: Controlled-Release Technology, Pharmaceutical Applications*. American Chemical Society, Washington, DC, 1987.
20. Scholes, P. D., Coombes, A. G. A., Illum, L., Davis, S. S., Watts, J. F., Ustariz, C., Vert, M., and Davies, M. C. Detection and determination of surface levels of poloxamer and PVA surfactant on biodegradable nanospheres using SSIMS and XPS. *J. Controlled Release* 59:261–278, 1999.
21. Davies, M. C., Brown, A., Newton, J. M., *et al.* SSIMS and SIMS imaging analysis of a drug delivery system. *Surface Interface Anal.* 11:591–595, 1988.
22. Belu, A., Bryan, S., Davies, M. C., and Patel, N. Characterization of pharmaceuticals by TOF-SIMS. In *SIMS XII Proceedings of the 12th International Conference on Secondary Ion Mass Spectrometry*, Brussels, Belgium, September 5–11, 1999. Elsevier Science, Amsterdam, 2000.
23. Available at http://www.phi.com/products/sims/what_is_tof_sims.htm.
24. Whitley, A. and Barnett, S. Advances and useful applications of Raman spectroscopy, imaging, and remote sensing. *SPIE* 3261:250–259, 1998.
25. Breitenbach, J., Schrof, W., and Neumann, J. Confocal Raman spectroscopy: analytical approach to solid dispersions and mapping of drugs. *Pharm. Res.* 16(7):1109–1113, 1999.
26. Czurczak, E. W. Use of near infrared for discriminate analysis of pharmaceutical raw materials. In *Pittsburgh Conference of Analytical Chemistry and Applied Spectroscopy*, February 1985, New Orleans, LA.
27. Whitfield, R. G. Near-infrared reflectance analysis of pharmaceutical products. *Pharm. Manufacturing* April:31–40, 1986.
28. *ICH Guidelines for Method Validation: Q2A Text on Validation of Analytical Procedures*, 1995.
29. *ICH Guidelines for Method Validation: Q2B Validation of Analytical Procedures: Methodology*, 1996.

30. Trafford, A. D., Jee, R. D., and Moffat, A. C. The application of ICH guidelines to the validation of a NIR intact quantitative assay method. *Pharmsci.* 1 Suppl. 1:5-21, 1998.
31. Ritchie, G. E. and Ciurczak, E. W. Validating a near-infrared spectroscopic method. In *Spectroscopy in Process and Quality Control Conference Proceedings*, East Brunswick NJ, 1999.
32. Near-infrared spectrometry. In *European Pharmacopoeia, Physical and Physicochemical Methods*, Section 2.2.40, pp. 43-44, 1997.
33. Near-infrared spectrophotometry. *Pharmacopoeial Forum* 264(2):237-247, 2000.
34. *Standard Practice for Near-Infrared Qualitative Analysis*, ASTM E 1790-96, p. 2, Section 5.2.2. American Society for Testing and Materials, West Conshohocken, PA, 1996.
35. *Standard Practices for Infrared Multivariate, Quantitative Analysis*, ASTM E 1655-94, p. 2, Sections 6-6.1.7. American Society for Testing and Materials, West Conshohocken, PA, 1994.
36. Ritchie, G. E., Gehrlein, L., and Ciurczak, E. W. Simultaneous development, validation and implementation of a near-infrared (NIR) diffuse reflectance spectroscopic identification method for pharmaceutically active and inactive (placebo) clinical dosage forms. In *Pittsburgh Conference of Analytical Chemistry and Applied Spectroscopy*, March 2000, New Orleans, LA.
37. Ciurczak, E. W. Following the progress of a pharmaceutical mixing study via near-infrared spectroscopy. *Pharm. Tech.* 15(9):87, 1991.
38. Tso, C., Ritchie, G., Ciurczak, E., and Gehrlein, L. Purdue Pharma, L.P. unpublished report, March 22, 2000.
39. Workman, J., Jr., and Brown, J. A new standard practice for multivariate quantitative infrared analysis. Part I. *Spectroscopy* 11(2):48-51, 1996.
40. Workman, J., Jr. and Brown, J. A new standard practice for multivariate quantitative infrared analysis. Part II. *Spectroscopy* 11(9):24-29, 1996.
41. Ritchie, G. E., Ciurczak, E. W., and Mark, H. Validation of a near-infrared transmission (NIT) spectroscopic assay of sustained-release prescription analgesic tablets. In *Pittsburgh Conference of Analytical Chemistry and Applied Spectroscopy*, March 2000, New Orleans, LA.
42. Roller, R. W. Intact capsule content uniformity feasibility by NIR solid dose. In *Pittsburgh Conference of Analytical Chemistry and Applied Spectroscopy*, March 2000, New Orleans, LA.
43. Cho, J. H., Gemperline, P. J., and Walker, D. S. Wavelength calibration method for a CCD detector and multichannel fiber-optic probes. *Appl. Spectrosc.* 49(12), 1995.
44. Cho, J. H., Gemperline, P. J., Salt, A., and Walker, D. S. UV/visible spectral dissolution monitoring by in situ fiber-optic probes. *Anal. Chem.* 67(17):2858-2863, 1995.
45. Aldridge, P. K. and Kostek, L. J. In situ fiber-optic dissolution analysis. *Dissolution Technol.* 2(4):10-11, 1995.
46. Bynum, K. C. and Kraft, E. A new technique in dissolution testing. *Pharm. Technol.* 23(10):42-44, 1999.
47. Bynum, K. C., Kraft, E., Pocreva, J., Ciurczak, E. W., and Palermo, P. In situ dissolution testing using a fiber-optic probe dissolution system. *Dissolution Technol.* 6(4):8-10, 1999.
48. Earnhardt, J. and Nir, I. Fiber-optic dissolution testing advances drug quality control, *Spectroscopy* 15(2):30-34, 2000.
49. Schatz, C., Ulmschneider, M., Altermatt, R., and Marrer, S. Reader's response: hollow-shaft sampling with fiber optics. *Dissolution Technol.* 7(1):20-21, 2000.
50. Available at <http://www.delphian-tech.com/index.asp>.
51. Memon, M. A., Panhwar, E., and Memon, M. A. Flow injection spectrophotometric determination of aspirin in tablets. *Sci. Instrum.* 11(4):421-423, 1999.
52. Benli, P. and Tuncel, M. Flow-injection analysis of ambroxol in pharmaceutical tablets. *Pharmazie* 53(3):203-204, 1998.
53. Ayora-Canada, M. J., Pascual-Reguera, M. I., Ruiz-Medina, A., Fernandez de Cordova, M. L., and Molina Diaz, A. Fast determination of paracetamol by using a very simple photometric flow-through sensing device, *J. Pharm. Biomed. Anal.* 22(1):59-66, 2000.
54. Ortega-Barrales, P., Ruiz-Medina, A., Fernandez-De Cordova, M. L., and Molina Diaz, A. Sensitive and simple determination of diclofenac sodium by use of a continuous flow-injection procedure with solid-phase spectroscopic detection. *Anal. Sci.* 15(10):985-989, 1999.

55. Ruiz-Medina, A., Fernandez-de Cordova, M. L., and Molina-Diaz, A. Integrated flow injection-solid phase spectrophotometric determination of minoxidil. *Talanta* 50(2):277–282, 1999.
56. Ruiz-Medina, A., Fernandez-de Cordova, M. L., and Molina-Diaz, A. A very simple resolution of the mixture paracetamol and salicylamide by flow injection-solid phase spectrophotometry. *Anal. Chim. Acta* 394(2–3):149–158, 1999.
57. Fang, Q., Sun, Y., and Fang, Z. Automated continuous monitoring of drug dissolution process using a flow injection online dialysis sampling, solvent extraction separation spectrophotometric system. *Fresenius J. Anal. Chem.* 364(4):347–352, 1999.
58. Teixeira, L. S. G., Rocha, F. R. P., Korn, M., Boaventura, F. Reis, Sérgio, L. C. Ferreira, and Antonio, C. S. Costa. Flow-injection solid-phase spectrophotometry for the determination of zinc in pharmaceutical preparations. *Anal. Chim. Acta*, 383(3):309–315, 1999.
59. Solich, P., Polydorou, C. K., Koupparis, M. A., and Efstathion, C. E. Automated flow-injection spectrophotometric determination of catecholamines (epinephrine and isoproterenol) in pharmaceutical formulations based on ferrous complex formation. *J. Pharm. Biomed. Anal.* 22(5):781–789, 2000.
60. Rao, Y., Zhang, X., Luo, G., and Baeyens, W. R. G. Chemiluminescence flow-injection determination of furosemide based on a rhodamine 6G sensitized cerium (IV) method. *Anal. Chim. Acta* 396(2–3):273–277, 1999.
61. Ouyang, J., Baeyens, W. R. G., Delanghe, J., van der Weken, G., and Calokerinos A. C. Cerium (IV)-based chemiluminescence analysis of hydrochlorothiazide. *Talanta* 46(5):961–968, 1998.
62. Liang, Y., Li, J., Zhang, Z., and Zhang, X. Flow injection determination of prednisone acetate. *Yaowu Fenxi Zazhi* 18(3):168–170, 1998.
63. Xue, Y., He, Y., Feng, M., and Lu, J. Determination of promethazine hydrochloride by flow injection analysis with chemiluminescence detection. *Fenxi Huaxue* 27(4):427–429, 1999.
64. Xue, Y., He, Y., and Lu, J. Chemiluminescence reaction of imipramine-glyoxal-potassium permanganate system. *Fenxi Shiyanshi* 18(3):49–51, 1999.
65. Wang, Y. Spectrophotometric determination of phenothiazines in pharmaceuticals by flow-injection analysis. *Zhongguo Yiyao Gongye Zazhi Bianjibu* 30(3):133–134, 1999.
66. Dow, A. D., Finlay, G., and Bloomfield, M. S. The determination of busulphan in dissolution samples by flow injection analysis. *J. Pharm. Biomed. Anal.* 19(3–4):549–554, 1999.
67. Dolejsova, J., Karlicek, R., and Pospisilova, M. Determination of dichloroquinolinol in tablets by flow injection analysis. *Ceska Slov. Farm.* 47(5):229–232, 1998.
68. Karlicek, R. and Solich, P. Flow-injection spectrophotometric determination of captopril using online solid phase extraction. *Pharmazie* 53(8):549–551, 1998.
69. Richter, P., Toral, M. I., Quiroz, G., and Jaque, P. Flow-through polarographic cell for flow-injection analysis. Determination of nifedipine in pharmaceutical formulations. *Lab. Rob. Autom.* 9(5):255–262, 1997.
70. Danet, A. F., David, V., and David, I. Acetaminophen determination by flow injection analysis with biamperometric detection, *Rev. Roum. Chim.* 43(9):811–816, 1998.
71. Kubota, L. T., Fernandes, J. C. B., Rover, L., and de Oliveira Neto, G. Determination of acetylsalicylic acid by FIA-potentiometric system in drugs after on-line hydrolysis. *Talanta* 50(3):661–667, 1999.
72. Liu, W. Z. and Zuo, A. L. Construction and application of all-solid-state aconitine electrochemical detector in flow injection analysis. *Yaouxue Xuebao* 27(4):294–298, 1992.
73. Safavi, A. and Mirzaee, M. Spectrofluorimetric kinetic determination of selenium (IV) by flow injection analysis in cationic micellar medium. *Talanta* 51(2):225–230, 2000.
74. Ruiz-Medina, A., Fernandez-de Cordova, M. L., and Molina-Diaz, A. Flow injection-solid phase spectrofluorimetric determination of pyridoxine in presence group B vitamins. *Fresenius J. Anal. Chem.* 363(3):265–269, 1999.
75. Bautista, J. A. G., Mateo, J. V. G., and Calatayud, J. M. Spectrofluorimetric determination of iproniazid and isoniazid in an FIA system provided with a solid-phase reactor. *Anal. Lett.* 31(7):1209–1218, 1998.
76. Laredo-Ortiz, S., Rivas, G. A., and Martinez-Calatayud, J. FIA-fluorimetric assembly for the determination of noradrenaline hydrochloride by a solid-phase reactor with immobilized hexacyanoferrate (III). *Mikrochim. Acta* 126(1–2):69–72, 1997.

77. Kojlo, A. and Martinez-Calatayud, J. FIA—fluorimetric determination of adrenaline by oxidation with a solid-phase reactor of manganese dioxide incorporated in polyester resin beads. *Anal. Lett.* 28(2):239–247, 1995.
78. Skeggs, L. T. An automatic method for colorimetric analysis. *Am. J. Clin. Pathol.* 28:311, 1958.
79. Dunkerley, S. and Adams, M. J. A general robot control system for automatic chemical analysis. *Lab. Autom. Inf. Management* 33(2):93–105, 1997.
80. Isenhour, T. L., Lee, J. R., Zhou, T., and Marshall, J. C. The Analytical Directory Project. In *Proceedings of the Zymark Robotics Conference*, pp. 606–617, 1992.
81. Corkan, L. A. and Lindsey, J. S. Experiment manager software for an automated chemistry workstation, including a scheduler for parallel experimentation. *Chem. Intell. Lab. Syst. Lab. Inf. Management* 17:47–74, 1992.
82. Buhlmann, R., Carmona, J., Donzel, A., Donzel, N., and Gil, J. An open software environment to optimise the productivity of robotised laboratories. *J. Chromatogr. Sci.* 32:243–248, 1994.
83. Plouvier, J. C., Corkan, L. A., and Lindsey, J. S. Experiment planner for strategic experimentation with an automated chemistry workstation. *Chem. Intell. Lab. Syst. Lab. Inf. Management* 17:75–94, 1992.
84. Aloba, O. T., Bergman, D. E., Miller, R., and Daly, R. E. Enhanced robotic dissolution system with concurrent off-line analysis. *J. Pharm. Biomed. Anal.* 11(10):861–869, 1993.
85. Rosen, J. M., O'Leary, M., Fotino, W., Ryall, R. R., and Gehrlein, L. PyTechnology robotic sample preparation procedures for potency and content uniformity analysis of cefixime, an orally active cephalosporin solid dosage form. *Adv. Lab. Autom. Rob.* 5:363–379, 1989.
86. Plavcan, K. A., Kurtz, T., Lichtenstein, M. S., and Bird, B. A. Validation of a robotic dissolution assay for a sugar coated immediate release tablet. *Adv. Lab. Autom. Rob.* 6:125–136, 1990.
87. Kentrup, W. A. and Huth, J. Automated assay of sabril tablets using the BenchMate workstation. *Proc. Int. Symp. Lab. Autom. Rob.* 187–191, 1991.
88. Kanczewski, E. G., Miller, R., Skrilec, M., and Daly, R. E. Robotic moisture determination of solids in the pharmaceutical industry. *Proc. Int. Symp. Lab. Autom. Rob.* 137–153, 1991.
89. Matsuda, R., Hayashi, Y., Ishibashi, M., and Takeda, Y. Totally automated robotic system for liquid chromatographic analysis of solid dosage formulations with the aid of a reduced Kalman filter. *J. Chromatogr.* 438(2):319–327, 1988.
90. Merdian, S. J. and Lanese, J. G. Robot-GC as a tool for uniformity of dose. *J. Chromatogr. Sci.* 25(5):210–213, 1987.
91. Cohen, B. L. Automated column and solvent selection for fully automated HPLC analyses of tablet content uniformity. *J. Chromatogr. Sci.* 25(5):202–205, 1987.
92. Aldridge, P. K., Melvin, D. W., Williams, B. A., *et al.* A robotic dissolution system with online fiber-optic UV analysis. *J. Pharm. Sci.* 84(8):909–914, 1995.
93. Van der Voorden, E. C., Gout, E., Van Hulst, O. L. T., and Vendrig, D. E. M. M. Use of an automated robotic system for the extraction and on-line high-performance liquid chromatographic analysis of pharmaceutical formulations. *Chemo. Intell. Lab. Syst.* 17(1):129–135, 1992.
94. Conder, S. Robot automation of routine assays in the stability testing of solid dosage forms. *Proc. Int. Symp. Lab. Autom. Rob.* 116–136, 1992.
95. Brown, B. A., Curley, J. E., and Kostek, L. J. Preparation of tablet samples for HPLC analysis using a Zymate Py System in a custom mode and supplemented with a BenchMate workstation. *Proc. Int. Symp. Lab. Autom. Rob.* 196–222, 1992.
96. Scypinski, S., Nelson, L., and Sadlowski, T. Automation in the pharmaceutical analysis laboratory: a centralized/decentralized approach. *J. Autom. Chem.* 17(2):47–49, 1995.
97. Berridge, J. C. Chemometrics in pharmaceutical analysis. *Analyst* 112(4):385–389, 1987.

This Page Intentionally Left Blank

7

PARENTERAL DOSAGE FORMS

GREGORY A. BIRRER, SATYA S. MURTHY, and JIE LIU

*Baxter Anesthesia Critical Care, Baxter Healthcare Medication Delivery, 95 Spring Street,
New Providence, New Jersey 07974*

JUDY ESTRADA

Gensia-Sicor, Pharmaceuticals, 19 Hughes, Irvine, California 92618-1902

- I. CHARACTERISTICS OF PARENTERAL DOSAGE FORMS
- II. PHARMACEUTICAL ANALYSIS DURING FORMULATION AND PROCESS DEVELOPMENT
- III. ANALYTICAL TESTING FOR FINISHED PARENTERAL PRODUCTS
- IV. PACKAGING COMPONENTS TESTING
- V. PROCESS DEVELOPMENT SUPPORT
- VI. IN-PROCESS TESTING
- VII. RELEASE TESTING
- VIII. RAW MATERIAL TESTING
- IX. VALIDATION OF ANALYTICAL PROCEDURE
- X. STABILITY-INDICATING METHODS
- XI. METHOD TRANSFER
- XII. CLEANING METHOD VALIDATION
- XIII. ADMIXTURE STUDIES
- XIV. MICROBIOLOGICAL TESTING OF PARENTERAL FORMULATIONS
- XV. STERILITY TESTING
 - A. Sterility Test Methods
 - B. Sterility Test Growth Media
 - C. Number of Units Sampled
 - D. Time and Temperature of Incubation
 - E. Interpretation of Results
 - F. Validation and Controls for the Sterility Test—Growth Promotion and Bacteriostasis and Fungistasis Testing
 - G. Limitations to the Sterility Test
 - H. Innovations in and Improvements to the Sterility Test
- XVI. BACTERIAL ENDOTOXIN TESTING
 - A. Basic LAL Test Procedure
 - B. Inhibition and Enhancement Testing
 - C. Variations and Alternative LAL Methods
 - D. Endotoxin Contamination in Product
- XVII. PARTICULATE MATTER TESTING
 - A. Automatic Container Inspection Machines
 - B. USP Test for Particulate Matter (Subvisual)
 - C. Interpretation of Results—Particulate Matter Testing
- XVIII. BIOBURDEN TESTING OF PARENTERAL PRODUCT SOLUTION
 - A. Bioburden Sampling
 - B. USP Microbial Limit Test

- C. Conducting TAC and TYMC by Pour-Plate Method
- D. Conducting TAC and TYMC by Membrane Filtration Method
- E. Preparatory Testing (Bioburden Recovery Validation)
- F. Setting and Using Bioburden Limits
- G. Prevention of Bioburden Contamination in Parenteral Formulation Areas
- XIX. INTRODUCTION TO CLEANING VALIDATION
- XX. SWAB SELECTION (RECOVERY AND COMPATABILITY STUDIES)
- XXI. TECHNICIAN QUALIFICATION
- XXII. SAMPLING
- XXIII. ACCEPTANCE CRITERIA
- XXIV. METHODS OF ANALYSIS
- XXV. GROUPING/MATRIX APPROACH
- XXVI. VALIDATION PROTOCOL
- XXVII. VALIDATION REPORT
- XXVIII. SUMMARY
- REFERENCES

A parenteral dosage form can be defined as a sterile drug product, which is presented in the form of solution, suspension, emulsion, or reconstituted lyophilized powder, suitable for administration by injection. Typical routes of administration of a parenteral dosage form include subcutaneous, intramuscular, and intravenous delivery. Occasionally, parenteral dosage forms can also be administered via intrathecal, intracisternal, intraarterial, intraspinal, intraepidural, and intradermal routes to achieve local or systemic effects. Although a major drawback of parenteral delivery is the pain and discomfort associated with needle injection, significant usage has been maintained in hospital environments. This is due to the unique attributes of the parenteral dosage form: rapid absorption and distribution, high bioavailability, zero enzymatic degradation in the gastrointestinal tract, and an ability to be administered to unconscious patients.

Parenteral products, by nature of the fact that they are administered directly into the human bloodstream, bypass virtually all of the body's inherent barriers to infection. They are also riskier than oral solid dosage products because there is a higher propensity for improper administration of injectable products as well as the reality of patients with compromised immune systems, among other things. It is for these reasons that the utmost attention to—and assurance of—quality, safety, and efficacy are required to properly manufacture the parenteral dosage form.

I. CHARACTERISTICS OF PARENTERAL DOSAGE FORMS

The unique attributes of a parenteral dosage form are the following:

- Sterility
- Freedom from pyrogenic contamination and endotoxins
- Freedom from particulate matter
- Physical, chemical, and microbiological stability

- Compatibility with other parenteral products in an admixture if coadministration is necessary
- Isotonicity

Therefore, pharmaceutical scientists should provide methods to evaluate parenteral products to verify that each of the aforementioned requirements is properly met.

II. PHARMACEUTICAL ANALYSIS DURING FORMULATION AND PROCESS DEVELOPMENT

During the preformulation and formulation stages of a parenteral dosage form, the physicochemical properties and excipient compatibility of the pharmaceutical active ingredient (API) should be thoroughly evaluated. The test method requirements are similar to those for oral dosage forms.

The properties that are to be evaluated for the API during the preformulation stage include the following:

- Color and odor
- Particle size, shape, and crystallinity
- Melting point and thermal analytical profile
- Hygroscopicity
- Absorbance spectra
- Solubility as a function of pH in a typical range of pH 2–11
- pH of the solution, and pK_a of the API
- Stability profile as a function of solution pH
- Heat, light, and oxygen sensitivity of the drug substance (API)
- Accelerated stability of the drug substance (API)
- Impurity profile

The most frequently encountered challenge during parenteral formulation is solubilization of the drug substance to achieve an aqueous solution with an adequate concentration. Excellent review articles on solubilization of drug substance for parenteral formulation can be found in the literature.¹ Formation of salt, pH adjustment using a buffer system, and incorporation of a co-solvent are common formulation maneuvers to tackle this problem. Thus, evaluation of the stability and solubility of the drug substance as a function of pH is critical during the preformulation stage. An accurate analytical method, such as high-performance liquid chromatography (HPLC) is required for this purpose. Although a fully validated analytical method may not be necessary at this point, the method should be able to discern the drug substance from its degradation products and provide an accurate assay for the potency of the drug substance.

Parenteral dosage forms can be categorized as small-volume parenteral (SVP), large-volume parenteral (LVP), and lyophilized products. Three basic types of SVP formulations exist: solution, suspension, and emulsion. The following aspects should be addressed to successfully formulate a parenteral dosage form: (1) selection of a suitable vehicle (aqueous, co-solvent, or non-aqueous); (2) selection of formulation adjuvants, such as buffering agents,

antioxidants, antimicrobial agents, osmolality adjusting agents, chelating agents, surfactants (in the case of an emulsion), and suspending agents (in the case of suspension); (3) processing equipment: selection of the compounding tank in terms of the contact surface (stainless steel surface, glass-coated surface, and Teflon-coated surface), selection of the transportation tubing material, selection of compatible filter membranes, selection of homogenizer (in the case of suspension and emulsion), and selection of appropriate lyophilization cycle (in the case of lyophilized dosage form); (4) determination between terminal sterilization and aseptic process; (5) final packaging system (container closure integrity); and (6) stability of the finished product. The principles and guidelines for parenteral formulation can be found in a series of books by Avis *et al.*² In correspondence to the various formulation aspects, the following studies are necessary during the formulation stage:

- Solubility of the drug substance and other critical excipients in water and co-solvent systems
- Solubility of the drug substance and other critical excipients in different buffer systems
- Metal compatibility, filter absorption, and plastic tubing/stopper absorption study
- Autoclave study (terminal sterilization)
- Comparison to innovator product (for generics)
- Testing of container and closure components
- Particle size distribution of suspension or emulsion
- Water content of the lyophilized products
- Stability evaluation of the finished product, including sensitivity to light and/or headspace oxygen

Most of these studies require analysis of the formulation in terms of the potency assay of the drug substance and other critical excipients. Consequently, an analytical method such as HPLC is required.

III. ANALYTICAL TESTING FOR FINISHED PARENTERAL PRODUCTS

To ensure that each of the aforementioned requirements for a parenteral product is properly met, the following chemical and microbiological tests are typically conducted for the finished products.

Chemical testing includes

- Identification test for the pharmaceutical active ingredient
- Potency assay
- Determination of degradation products or process related impurities
- pH
- Osmolality
- Appearance (color testing)
- Assay for the contents of critical excipients and their major degradation products (e.g., dextrose and 5-hydroxymethylfurfural, and ethanol)
- Particle size distribution for suspensions and emulsions

- Water content for lyophilized dosage forms

Microbiological testing includes

- Sterility testing
- Bacterial endotoxin testing
- Particulate matter testing
- Bioburden analysis (bulk)
- Container/closure integrity

IV. PACKAGING COMPONENTS TESTING

Packaging components for parenteral products are generally composed of three items: glass/plastic containers, elastomeric closures, and plastic bags. Selection of the packaging components depends on the compatibility between the formulation and the packaging material and on any special requirement of the formulation.

Type I glass, as defined in *USP 24–NF 19*³ is borosilicate glass and is widely used for parenteral products, both in small volume vials ampules or in large volume infusion bottles. If possible, type II and type III glass should not be used for any parenteral products. Proof of compliance with United States Pharmacopeia (USP) specifications is required for regulatory filing. Compendial tests for glass include the light transmission test, chemical resistance test, powdered glass test, water attack at 121 °C, and arsenic test. Refer to *USP 24* for details of the test procedures. Typically, the supplier of the glass container can assist the parenteral pharmaceutical manufacturer in executing the compendial tests, and the certificate of analysis/compliance issued by the supplier can be utilized during the parenteral product regulatory filing.

Glass containers are inherently more stable than polymeric packaging components. However, alkaline substances may be extracted from the glass and sometimes may cause a significant shift in formulation pH, especially if the formulation is moderately acidic or neutral. In addition to pH change, the extractables from the glass container may adversely affect the stability of the formulation. The degree to which substances are extracted from the glass container also depends on the container surface area in contact per unit volume of content.⁴ If the shape and percentage fill of a container remain constant, the surface area per unit volume of contents is inversely proportional to the cube root of the volume. Consequently, small-volume parenteral products are exposed to potentially greater container influence than large-volume parenteral products. The influence of the glass container on the physicochemical attributes of the formulation, especially pH and chemical degradation of the active ingredients, should be evaluated during the sterilization cycles of the formulation and during the shelf life storage of the finished product.

Plastic containers are also widely used for packaging parenteral products, such as intravenous (IV) infusion fluid containers, irrigation fluid containers, prefilled disposable syringes, and some administration sets. Polymeric containers have an added advantage of low breakage and are preferred when the SVP product is a highly toxic material such as oncolytic drugs. Typical polymeric

materials used in the parenteral product market include polyvinyl chloride, cellulose, polypropylene, and polystyrene.⁵ Compendial tests for plastic containers include the light transmission test, biological tests for plastics and other polymers, and physicochemical tests intended to determine physical and chemical properties of the plastics and their extractables.³ Drug compatibility testing is another critical aspect for the plastic containers after the compendial tests are completed. The formulation should be placed into the plastic containers that are intended to be used as the primary packaging purpose. The test should ascertain any alteration due to the inability of the plastic material to fully protect the contents. The test should encompass the following aspects: the effect of the process and sterilization on the plastic material and the product, determination of potential leachability of the plastic material during sterilization and long-term storage, and long-term stability of the formulation while packaged in the primary packaging container.

Finally, elastomeric materials are used in packaging of parenteral products in the form of vial closures, syringe plungers, and other specialty components. A large variety of formulations exist for elastomeric materials used for parenteral products. The compatibility, extractables from the elastomers, and requirements for the clinical usage determine the selection of the type of elastomeric material. A good review of the elastomeric materials used for parenteral products can be found in the literature.⁶ The following criteria should be evaluated to qualify a type of elastomeric material to be used with a parenteral product: oxygen transmission, water vapor transmission, pressure to puncture, coring, resealability, biocompatibility, leachables tested according to USP specification,³ endotoxin removal, detergent removal, and break force. The suppliers of elastomeric components are generally qualified to help parenteral pharmaceutical manufacturers to select appropriate candidates. Thereafter, it is up to the pharmaceutical manufacturers to conduct compatibility studies between the elastomeric candidates and the drug formulation to finalize the selection. The compatibility tests should include the following aspects: adsorption of drug at the surface of the elastomeric material, absorption of drug dispersed in the elastomeric material, permeation of drug through the closure, and extractables of elastomeric ingredients into the drug product.

V. PROCESS DEVELOPMENT SUPPORT

A reliable analytical method must be available before preformulation studies are started and hence method development activities must precede preformulation activities. The analytical method should be capable of separating the active and any major degradation product(s) and thus be stability-indicating.^{7,8} Analytical methods such as titration and ultraviolet (UV) spectroscopy are not used since they are not considered to be stability-indicating. Only HPLC has been widely used as the method of choice in recent years because of its efficiency, applicability for a wide range of chemical compounds, and ease of automation.⁹

It is unlikely that the degradation reference standard will be available at this stage of the development program and therefore degradation products can be calculated by area percent. A preliminary validation of the method, which includes accuracy, precision, and linearity (at a minimum 75, 100, and 125% relative to the expected concentration of the API), must be performed. Specificity of the analytical method is demonstrated by subjecting the product to forced degradation stress studies, such as heat, acid, alkali, light, and peroxide and analyzing the resulting mixture. All degradation peaks must be clearly separated (with a minimum resolution of 2) from the active component peak. Peak purity of the analyte peak is evaluated by using a diode-array detector.^{10–12}

VI. IN-PROCESS TESTING

In-process testing is an essential part of the manufacturing process for parenteral pharmaceuticals. It is a quick way to confirm that the concentration of the active ingredient in the bulk solution is accurate and within specification limits. It is also used to test for homogeneity of the bulk solution by testing samples from top, middle, and bottom portions of the tank.

A convenient UV spectrophotometric method for in-process testing of the active ingredient is usually selected. A UV method can have a turnaround time of a few minutes compared with an HPLC method. Another advantage of the UV spectrophotometric method is that it does not require elaborate instrument and data acquisition systems and can be easily set up in a manufacturing environment.

Development of a spectrophotometric method can be challenging at times. The wavelength of detection used in the HPLC method may not be suitable for the UV spectrophotometric method. Due to the nature of the UV/visible (Vis) method, it is not specific and selective compared with HPLC analysis. Excipients in the formulation, for example, benzyl alcohol, may interfere with the active ingredient assay because it has a UV absorption with λ_{max} at 260 nm. In such cases, longer wavelengths (>300 nm) can be used, provided that the drug displays optimum UV absorption at a longer wavelength.

If use of an alternate wavelength is not possible, the composition of the reference and sample solutions can be made equivalent by adding an appropriate amount of the placebo matrix (formulation mixture without the active ingredient) into the reference standard solution mix. The absorption interference from the excipient will be equal in both the sample and the standard solution and is thus eliminated.

VII. RELEASE TESTING

A simple identification test is ordinarily required for parenteral pharmaceuticals. The identification test is typically a color development test performed by mixing the test product with a chemical reagent to produce a characteristic color. For example, phenolic compounds react with ferric chloride to produce an intense dark color. Sometimes when there is no unique color reaction test

available, a thin-layer chromatography (TLC) R_f value or an HPLC retention time comparison test is performed.

An HPLC method for the estimation of potency and determination of degradation products is an integral part of release testing. The analytical method should be stability indicating and capable of separating the active ingredient peak from degradation product, process impurity, and excipient-related peaks (Fig. 1).

In the analytical procedure, an accurately measured aliquot of the product is diluted with a diluent (normally the mobile phase) and the resulting sample solution is injected into the HPLC. Because the majority of injectable pharmaceuticals are clear solutions, typically a simple dilution step is all that is needed for sample preparation. However, if the parenteral product is an emulsion or a suspension, appropriate steps must be taken to dissolve the product to achieve a clear solution (ultrasonication, filtration, etc.). For the assay procedure, the sample concentration chosen should be such that the peak areas obtained from multiple injections from the same sample are reproducible with minimum variance (<2% relative standard deviation). Peak shape and retention time also play important roles in the precision of the assay. A tailing factor less than 1.5 and a capacity factor less than 10 for the active peak are generally required for a good analytical method. A reference standard solution having the same concentration and using the same diluent as the sample solution is prepared.

For the determination of degradation products, a concentrated sample solution is commonly used to enhance the sensitivity of the method. As a general rule, the method should be capable of quantitating with a reasonable precision 0.05% of the area obtained for the active peak. Whenever possible a degradation reference standard must be used for the estimation of each known degradation product. However, in many instances, degradation reference standards are not available. In such cases, an appropriate concentration of the reference standard solution of the active ingredient is used as a degradation standard. Any unknown peak is also estimated on the basis of the degradation standard solution. Relative response factors must be determined for each known degradation product and used in the calculation.

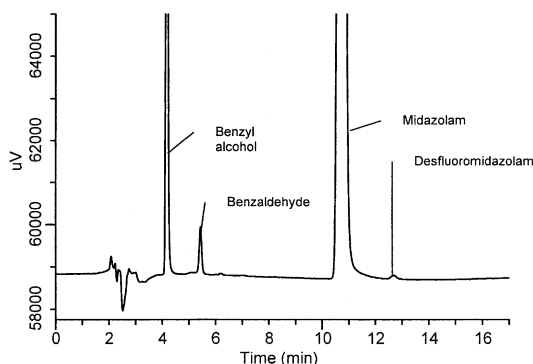

FIGURE 1 HPLC chromatogram of midazolam hydrochloride injection. (Benzyl alcohol and benzaldehyde are excipient-related peaks; desfluoromidazolam is an in-process impurity peak.)

As indicated above, the analytical method must be capable of distinguishing the active peak from impurity and/or degradation peaks along with excipient-related peaks; for example, dextrose-related 5-hydroxymethylfurfural (5-HMF),¹³ benzyl alcohol, and benzaldehyde. 5-HMF and related substances are degradation products of dextrose formed primarily during the heat sterilization processes. 5-HMF and related substances are tested spectrophotometrically at 284 nm according to the USP method (*Dextrose Injection, Official Monograph*).¹⁴ Because 5-HMF and related substances exhibit UV absorbance at 284 nm, they can potentially interfere with the separation and quantitation of active ingredient peaks in terminally sterilized formulations containing dextrose.

Process impurity peaks originating from the manufacturing process of the drug substance should be clearly identified in the analytical methodology with specific relative retention times so that they will not be treated as degradation products. Sometimes a process impurity can also be a degradation product and needs to be monitored as such. The percent impurity determined in the drug substance must be subtracted from the total peak area to calculate the degradant concentration resulting from degradation of the product.

Common excipients used in parenteral formulations include lactic acid, dextrose, sodium metabisulfite, and benzyl alcohol. An extensive list of parenteral excipients is found in the literature.¹⁵ Release testing for excipients is mandatory for parenteral drug products. Lactic acid can be determined by back titration of excess alkali with 0.1 N hydrochloric acid. Titration is performed after removing the active drug in the formulation by using an ion-exchange resin and boiling the solution with sodium hydroxide to remove carbon dioxide and to hydrolyze interesters of lactic acid. If the formulation also contains dextrose, the titration method for lactic acid cannot be used because treatment of dextrose with alkali results in hydrolysis of dextrose into organic acids. An alternate method for the determination of lactic acid is an enzymatic colorimetric method using the biochemical lactate reagent. The principle of the method involves conversion of the lactate to pyruvate and hydrogen peroxide by lactate oxidase. In the presence of the peroxide formed, peroxidase catalyzes the oxidative condensation of chromogenic precursors to produce a colored dye with an absorption maximum at 540 nm.^{16, 17} A modification of this method was successfully used for the determination of lactic acid in the injection formulation of a cardiotoxic drug. The interesters of lactic acid are hydrolyzed by overnight heating of the product in an oven at 100 °C.

Dextrose content in parenteral drug formulations is readily measured by the polarimetric method for the determination of dextrose in dextrose injection USP. When this is not feasible, for example, when the drug is optically active, HPLC methods are available using refractive index or electronic light-scattering detectors. However, the HPLC methods are currently used mainly for research and are not commonly used in quality control (QC) laboratories. Dextrose undergoes thermal degradation to 5-HMF and related substances during the terminal sterilization autoclave cycle. The USP describes a UV limit test for the control of dextrose-related degradation products in dextrose injection (not more than 0.25 absorbance unit at 280 nm). The nature of dextrose degradation during moist heat sterilization has been investigated by a number

of researchers who showed that the amount of degradation products formed is nontoxic at levels below the USP specification limit for 5-HMF-related substances.¹⁸

Metabisulfite analysis can be performed by oxidation with a measured volume of 0.1 N iodine in acid solution and determination of excess of iodine by titration with sodium thiosulfate. The metabisulfite titration can be performed manually using a starch indicator or potentiometrically using an autotitrator.

pH determinations are performed routinely for release testing of parenteral pharmaceuticals. pH determinations must be performed potentiometrically according to the USP methodology. Buffer solutions for standardization can be prepared according to the USP guidelines. Commercially available buffer solutions can be used when they are standardized by methods traceable to the National Institute of Standards and Technology. Before test sample measurements, the pH meter should be standardized using two buffer solutions that bracket the expected test material pH and whose difference in pH does not exceed 4 units.

Osmolarity is a fundamental physical property of solutions related to diffusion of solutes through biological membranes. Osmolarity expressed as milliosmols per liter depends on the number of species in solution. Apart from the drug, the excipients in solution will also contribute to osmolarity of a drug product. Theoretical calculations can be made to determine the expected osmolarity of a drug product and compared to the experimental results. Osmolarity determinations are made using osmometers that measure freezing point depression of the test solution. The depression in freezing point is correlated to milliosmolarity.

VIII. RAW MATERIAL TESTING

Release testing of raw materials or drug substances must be performed before they can be used for manufacturing a batch of the product. Assay and ordinary impurity determinations are usually performed by HPLC methods. However, when a reference standard for the active ingredient is not available, assay by titration is the method of choice.

Whenever possible, it is beneficial to have similar HPLC methods for the drug substance and the drug product with only variations in the sample preparation techniques. The method should be capable of separating the active ingredient from in-process impurities and be able to detect and quantitate low levels of impurities (0.05%).¹⁹ When the same method is used for the release and stability testing of the drug product, the in-process impurity peaks must be labeled as such to avoid their being calculated as degradation products. However, in some instances, a process impurity can also be a degradation product and must be monitored in the drug product. Formation of laudanosine from atracurium besylate is one such example.²⁰

In the HPLC drug substance methodology, it is advantageous to have a different sample concentration for the assay and in-process impurity determinations. The impurity method should consist of sufficiently high concentration of the test sample such that the impurities at 0.05% levels will have sufficient

signal-to-noise ratios and give reproducible peak areas. At such concentrations, the area and shape of the active peak are not suitable for assay determination. Therefore, an appropriate lower concentration of the sample must be used for the assay determination.

When impurity reference standards are available only in limited quantities, relative response factors (RRFs) to the active ingredient can be used to quantify impurity concentrations. RRFs can be determined spectrophotometrically by comparing the molar absorptivity of the impurity to that of the active component. However, in our experience, RRFs determined by HPLC by comparing peak area responses of the impurity to those of the active ingredient have been more accurate than those determined by spectrophotometric method.

TLC methods can also be used for the determination of in-process impurities in drug substances.^{21,22} TLC methods are only semiquantitative when visual comparison of the size and intensity of spots is performed. Quantitative measurements are possible by means of densitometry or fluorescence measurements. The spots can also be carefully removed and dissolved in a suitable solvent for spectrophotometric measurement.

Residual solvent analysis for drug substances is performed by gas chromatographic methods. Tests for organic volatile impurities such as benzene, chloroform, 1,4-dioxane, methylene chloride, and trichlorethylene along with any other specific organic solvents used in the synthesis process must be performed. If the manufacturer of the bulk drug can provide assurance, based on the knowledge of the bulk synthetic process, that there is no potential for the presence of any solvents, further testing for solvents is not required.

Monograph tests such as those for water, residue on ignition, chloride, sulfate, and heavy metal content are performed as part of the release testing of a bulk drug substance (API).

The near-infrared (NIR) spectroscopy technique is increasingly being used to perform raw material, in-process, and finished product testing for quality control.^{23–25} NIR spectroscopy makes use of weak absorption of various functional groups of organic compounds in the NIR region (800–2500 nm). NIR spectral information can be quickly obtained for a single substance or a multicomponent sample such as powders, suspensions, and emulsions because measurements can be made in reflectance or transmittance. Samples can be analyzed in their original containers without the need for sample preparation, and analysis is usually performed within a minute or less. The combination of quick analysis time and the elimination of sample preparation provides enormous advantages over traditional chromatographic and spectroscopic techniques. By eliminating the need for sample preparation, the NIR method provides improved method precision over chromatographic methods while equivalent accuracy is maintained.

IX. VALIDATION OF ANALYTICAL PROCEDURE

Validation is a process used to prove through scientific study that the analytical method is suitable for its intended use (see Chapter 12). Compendial methods have to be verified for suitability under actual conditions of use and

for a particular formulation. Guidelines for performing validation of analytical methodology can be found in another chapter of this book as well as in various sources and will not be discussed in detail here. We will discuss the subject only in general terms and include any unique situations related to parenteral formulations. For more detailed information on the number of samples to be prepared and analyzed during validation, the reader is advised to consult USP or International Conference on Harmonization guidelines.^{26–28}

Typical validation characteristics that should be considered are accuracy, precision, linearity, specificity, limit of quantitation, limit of detection, ruggedness, and robustness. Accuracy of the method is the exactness of the analytical method to the true value. Accuracy is determined by spiking known amounts of the analyte into a placebo matrix (without the active) and analyzing the samples according to the method. The analyte should be spiked into the placebo matrix at concentration values ranging from 50, 75, 100, 125, and 150% of the expected range. For impurity/degradation method validations, known amounts of impurity/degradation product must be spiked into a drug substance (API) or product. Accuracy is calculated as the percent recovery of the amount determined to the amount spiked. Precision is the degree of repeatability of the analytical method when it is performed on multiple samples obtained from a homogeneous mixture and is expressed as the relative standard deviation. Method precision is determined by analyzing at least six individual samples at 100% level, which are carried through all the steps from sample preparation to the final results according to the analytical procedure. System precision is an estimation of the reproducibility of the analytical instrument obtained by multiple analyses (six) of each solution (50–150% level) and calculation of the relative standard deviation. Linearity of the analytical method is determined by using linear regression analysis to deduce the relationship between instrument response and known concentrations of the analyte (usually 50–150% of the expected concentration). Specificity is the ability of the analytical method to measure the analyte in the presence of other components that are expected to be present. For the determination of specificity, samples are prepared by spiking possible interfering agents (impurities, degradation products, excipients, etc.) or by using forced degraded samples. Recovery of the analyte from the spiked sample is compared to that from the unspiked sample and a percent agreement is calculated. A percent agreement of close to 100% indicates the absence of any bias in the analytical procedure that is caused by the presence of interfering agents. Limit of detection (LOD) is the lowest concentration of the analyte in a sample that can be detected, but not quantitated. Limit of quantitation (LOQ) is the lowest concentration of the analyte in a sample that can be determined with acceptable precision. LOD and LOQ are determined by analyzing at least three low concentrations (12.5, 25, and 50% of the expected range for impurities/degradation) samples. The standard deviation for the analyte ($n = 5$) is calculated for each sample, and these are averaged to obtain the mean standard deviation associated with the analytical procedure within the lowest concentration range. The mean standard deviation divided by the slope and multiplied by factors of 3 and 10 provides an estimate of the LOD and LOQ, respectively. The estimated LOD

and LOQ must be verified experimentally by the analysis of a suitable number of samples at concentrations close to the LOD and LOQ.

The ruggedness of the analytical method is evaluated by having a second analyst independently repeat the accuracy, precision, and linearity measurements. The experiment must be conducted using different HPLC instruments and columns. The ability of the second analyst to reproduce the validation results of the primary analyst is taken as a proof of the ruggedness of the assay method.

Robustness is the ability of the method to withstand small, deliberate changes in the method parameters. It is evaluated by making small and deliberate changes in the method parameters and studying the effect on the system suitability requirements. These can include variations in flow rate, pH of the buffer, autosampler/column temperatures, and organic composition of the mobile phase as well as use of selective columns from different vendors.

X. STABILITY-INDICATING METHODS

Methods used to monitor the stability of pharmaceutical products must be specific to the major analyte and capable of separating the degradation and impurity peaks. The stability-indicating nature of the method can be demonstrated by subjecting the product to forced degradation (usually by heat, acid, alkali, light, and peroxide).²⁹ Conditions (time and temperature) must be controlled so that no more than 20–30% degradation occurs. The degraded samples are then analyzed according to the method. For the method to be stability-indicating, the degradation peaks must be sufficiently well resolved from the major component so that the specificity and accuracy of the method are not affected. Peak purity of the major component must be determined by using a diode-array detector or by using mass spectroscopy.³⁰

XI. METHOD TRANSFER

Methods are routinely transferred to QC/contract laboratories after development and validation. Before method transfer, the method, validation report, and transfer validation protocols must be documented. The written method should include system suitability requirements and acceptance criteria, details for the chromatographic parameters, column, mobile phase preparation, standard and sample preparation, and all calculations. Representative chromatograms for the resolution test mixture, standard solution, and sample solution and an expanded chromatogram showing the degradation/impurities must be included as part of the written method. The method transfer protocol should specify the tests for accuracy, precision, linearity, ruggedness, Lab to Lab variation and the corresponding acceptance criteria. The protocol must be reviewed and approved by the receiving laboratory manager before execution. Method training should be required and documented as part of the method transfer to familiarize the receiving laboratory with the new method before execution of the transfer protocol. It is preferable that the personnel

who were involved in the initial method development and validation should conduct method training in the receiving laboratory.

XII. CLEANING METHOD VALIDATION

Cleaning validation methods are important to minimize the risk of cross-contamination and potential adulteration of drug products.^{31, 32} Because sensitive and specific techniques are required to measure residual compounds in the parts per million concentration range, chromatographic methods are preferable to other techniques such as total organic carbon, UV/Vis spectrophotometry, conductivity, and pH. A modification of the product assay method is a good way to start development of the procedure. The assay procedure can be modified using a shorter column and increased flow rate to have quick elution of the analyte. Rinse samples are typically not required for routine release of manufacturing equipment once a thorough cleaning validation program has been executed. The validation of the cleaning method is performed as explained earlier in the chapter and the execution of cleaning validations will be discussed later in the chapter.

XIII. ADMIXTURE STUDIES

Injectable drugs are generally given initially as a bolus followed by a slow infusion. During infusion, the drugs are normally given as an admixture with an intravenous fluid such as 0.9% saline, 5% dextrose, or Ringer's solution. In a hospital, typically admixtures are prepared in the pharmacy to be used elsewhere and, therefore, there is a need to establish the short-term (24–72 h) physical and chemical stability of admixture solutions. Parenteral drugs are also used in combination with other drugs, and compatibility data for such admixture solutions are critical. Therefore, admixture studies must be performed with various intravenous diluents to demonstrate the stability of the drug product admixture. Admixture studies are performed by mixing an appropriate amount of the drug product into a flexible intravenous infusion bag containing the diluent to give a predetermined concentration of the active drug.³³

Therefore, admixture studies are performed on parenteral drugs with commonly used intravenous diluents. Studies are performed by preparing admixtures of the drug product with various diluents in an appropriate type of flexible intravenous bag. Initial samples are taken for analysis before the bags are stored in temperature-controlled stability chambers. Subsequent samples may be pulled at 6-, 12-, 24-, 48-, and 72-h time points. The analytical tests commonly performed include visual appearance, pH, and HPLC assay. Degradation products are not commonly tested unless the method has been previously evaluated for specificity and stability-indicating ability with a particular intravenous diluent. This is necessary because there may be differences in the stability profile of the product in its original formulation compared to the admixture solution. Formation of any particulate matter is detected by visual

examination of the admixture sample while pH and assay results indicate the chemical stability of the admixture. A slight modification of the analytical procedure used for the drug product may be necessary for the analysis of admixture solutions. This may include adjusting the sample dilution to achieve the same concentration of the sample as detailed in the validated analytical method. In some cases, mobile phase composition may be modified slightly to separate interfering peaks arising from the diluent (e.g., dextrose-related peaks).

XIV. MICROBIOLOGICAL TESTING OF PARENTERAL FORMULATIONS

Parenteral dosage forms are distinct from other pharmaceutical products in that they must be demonstrably free of viable microbial contamination (sterile), bacterial endotoxins (pyrogens), and foreign particulate matter. It is the attainment of these three attributes that poses the most difficult challenge for the parenteral product manufacturer and the associated testing laboratories. The ability to properly make a parenteral product is the culmination of using specially designed and qualified manufacturing facilities such as clean rooms or aseptic processing areas and equipment combined with a rigorous program of microbiological testing, monitoring, and control.

Microbiological testing plays a central role in many aspects of parenteral quality control and assurance. It must be performed on the drug substance or API, the raw materials or excipients, and the final drug product.⁵³ Microbial monitoring and testing programs are implemented within a parenteral manufacturing facility to qualify and then assure the continued upkeep of an aseptic environment. Microbiological monitoring of the manufacturing environment and of the personnel in the aseptic processing areas must be carried out to ensure protection of the product during manufacture. Prescribed levels of contamination control are mandated and maintained according to the types of manufacturing activities planned for a given area, the level of product exposure, and whether the product is terminally sterilized or aseptically filled. Media-filling simulations to support aseptic processing are conducted after all the elements of a parenteral manufacturing area are considered validated or qualified. The simulation uses liquid microbiological growth media in place of product solution filled into the dosage units as the ultimate test of the robustness of the microbial control measures in the aseptic processing area, as well as the validation of heating, ventilation, and air condition/air systems, personnel training, and gowning. Microbiological testing with biological indicators is also used to validate manufacturing equipment such as steam autoclaves/sterilizers, depyrogenation ovens or tunnels, component-washing machines, and isolation units. Other tests, such as microbial challenge tests of sterilizing grade filter membrane material or sterile closures, are also necessary. This section will concentrate on microbiological testing done on the dosage form directly. The above-mentioned microbiological testing of manufacturing environments, personnel, and processing equipment are beyond the scope of this chapter. This material will be presented from a small-volume parenteral

manufacturing perspective; the philosophy and/or approach to microbiological testing may vary for large-volume parenteral products, in which case other sources should be consulted.

XV. STERILITY TESTING

Parenteral dosage forms carry the label claim that the contents are sterile. Theoretically, this refers to an absolute condition in which there is a complete absence of viable microorganisms (life). Operationally, the term “sterile product” means the batch or lot was tested and passed the USP sterility test (or other internationally recognized equivalent compendial test). The sterility test is not meant to be a stand-alone test but is used in conjunction with many other checks in concluding that a product may be labeled “sterile.” The sterility test is a destructive test. It is therefore impossible to test every item in a batch or lot. This means that every individual unit is not itself tested. Rather, the sterility test is an estimate of product sterility based upon the testing of a subset of units. This is the largest limitation of the test. It has been calculated, based on the sample size $n = 20$, that if as much as 1% of the units in a batch are nonsterile, there will only be an 18% probability of detecting the contamination event.³⁴ Another limitation is the propensity for false-positive test results due to handling errors in the laboratory (contamination will occur a certain percentage of the time; however, these events can be controlled).

The sterility test procedures specified in *USP 24-NF 19* (<71>)³ should be consulted for details of the test that are not covered in this chapter. The United States Code of Federal Regulations and other Current Good Manufacturing Practice guidance documents mandate that sterility testing be conducted (with passing results) for a product purporting to be sterile (CFR 211.167). See also the 1987 FDA guideline on Sterile Drug Products Produced by Aseptic Processing.³⁵

A. Sterility Test Methods

The USP describes two general methods for conducting the test: the direct transfer, or direct inoculation, method and the membrane filtration method. As the name indicates, the direct inoculation method involves the aseptic transfer of a sample of test product solution into the sterility test growth medium. To use this method, it must first be demonstrated that the product solution itself does not inhibit the growth of typical “indicator” microorganisms specified in the USP method. It should be self-evident why it is important to perform testing to negate the chance of product inhibition of possible microbial contaminants, as this is the purpose of the sterility test. The direct inoculation method, while not theoretically complex, requires the utmost technical precision and aseptic manipulation techniques for proper execution. As a consequence of the repetitive motions involved, it is prone to human error.

The membrane filtration method is specified by the USP to be used whenever “the nature of the product permits.”³ The direct transfer method should

be used only when it is not possible to properly perform the membrane filtration method. Therefore, membrane filtration is the most widely used method in the industry. It involves a pressure or vacuum filtration of the test product solution through a sterile filtration apparatus fitted with a filter membrane (thus capturing any microbial contaminants on the membrane) then either a wash step with a sterile diluent and/or subsequent plating of the membrane filter onto the surface of an agar plate. When the membrane filtration method is used, it is imperative that a sterile diluting fluid be used to (1) rinse away any microbial cells residing on the filtration apparatus and ensure their impingement onto the filter surface and (2) dilute or otherwise wash away any product residue that might inhibit subsequent microbial cell growth. There are commercially available presterilized systems that are widely used. These save time in preparation and setup, serve to expedite the testing, and help reduce the chance of laboratory contamination.

B. Sterility Test Growth Media

There are two types of media specified by the USP for use in the sterility test: (1) fluid thioglycolate medium (FTM) and (2) soybean–casein digest medium (SCD, also known as trypticase soy broth). FTM, although a liquid broth, still contains some agar (0.75 g/L). This causes the broth to behave somewhat like a semisolid and so it will not easily promote mixing with the headspace air. The ingredients sodium thioglycolate and L-cysteine act as reducing agents and help to form a low oxygen (microaerobic, approaching anaerobic) environment at the bottom of the tube. This allows for growth of most aerotolerant anaerobic microorganisms. There are some modifications to the formulation of FTM that are used in certain cases (for example, oily products and emulsions use polysorbate-80 in FTM; consult the USP for detailed instructions). SCD medium is used for culture of the majority of aerobic microorganisms. Generally, SCD promotes the growth of a wide range of fungi and bacteria.

Growth media can be made from chemical constituents in the laboratory or can be purchased either ready to use in sterile containers or as a dehydrated powder to be rehydrated and sterilized in the laboratory. The latter is considerably less expensive and has a far greater shelf life than the ready-to-use type. These media are modified if used for penicillins or cephalosporins by the addition of an appropriate amount of β -lactamase to inhibit the action of the antibiotics. The amount of inhibitor must be determined experimentally. For additional information on these and other types of growth media and their formulations, see *USP 24–NF 19* (<71>)³ or a manufacturer's manual such as the *Difco Manual*.³⁶

C. Number of Units Sampled

The number of units sampled for the test varies according to the following factors: (1) the number of units per batch, (2) the fill volume of the container, and (3) the method of product sterilization. Generally, 10–20 units are randomly sampled from the lot. If the lot size is between 20 and 200 units, then $n = 10$.

If the lot size is >200 units, then $n = 20$. However, there are many variations in sample size determination, and it is important to consult the USP, European Pharmacopeia (EP), or Japanese Pharmacopeia (JP) for detailed directions.

D. Time and Temperature of Incubation

Two incubation temperature ranges are specified by the USP: 20–25 °C for SCD and 30–35 °C for FTM. The 30–35 °C range is used because this approximates human body temperature and mesophilic organisms will grow. Many potential microbial contaminants would be of human origin such as the micrococci and staphylococci of skin flora. Environmental isolates such as mold, fungi, and bacilli prefer a slightly cooler growth temperature; this is the reason for different incubation temperatures. Incubation times have been established based on a “worst-case” growth scenario whereby slow-growing molds/fungi or damaged (viable nonculturable) aerobic bacteria may still be detected. The incubation period for aseptically filled (nonterminally sterilized) products is not less than (NLT) 14 days and for terminally sterilized products is NLT 7 days, *if* the membrane filtration method is used.³

E. Interpretation of Results

Interpretation of the sterility test results is straightforward—there should be no evidence of microbial growth (turbidity) in the media test containers. If microbial growth is observed in any of the tubes, it is considered a failing result. The test may, however, be repeated if there is documented evidence to invalidate the original test. A failing result should be sufficient grounds to reject the parenteral batch under test. The 1987 Food and Drug Administration (FDA) guideline on Sterile Drug Products Produced by Aseptic Processing states that “When persuasive evidence showing laboratory error is absent, or when available evidence is inconclusive, firms should err on the side of safety and batches should be rejected as not conforming to sterility requirements.”³⁵ Sterility test failure should be exhaustively investigated from the laboratory side as well as from the manufacturing environment and processing equipment perspectives. Identification of the microbial isolate from the positive test unit is required and offers the most valuable information about the root cause of the failure. The FDA aseptic processing guideline provides detailed guidance on conducting these investigations and should be consulted. The USP sterility test includes methods for testing other categories of products such as ointments, creams, solids, and sterile devices.

F. Validation and Controls for the Sterility Test—Growth Promotion and Bacteriostasis and Fungistasis Testing

The growth promotion test constitutes the positive control of the sterility test. Accordingly, if a failing growth promotion result is obtained, the sterility test is deemed to be invalid. Each lot of media is tested with preselected types and numbers of organisms to prove that the medium is/was capable of supporting

microbial growth. The sterility of the media must also be verified by incubating a portion of each sterilized batch of media or by including uninoculated controls during the sterility test procedure.

The sterility test is validated by successfully performing a bacteriostasis and fungistasis test for each product formulation to be tested. This ensures that the product formulation does not have any detrimental effect on the growth of potential microbial isolates, as evidenced by the demonstration of uninhibited growth of a preselected set of indicator organisms in the presence of the product. Because many sterile injectable products are formulated with preservatives, this test will determine if the preservative must be inactivated or diluted away from the test filter membrane by use of a sterile rinse step. If the results indicate that the formulation inhibits the growth of the USP indicator organisms, it would preclude the option of using the direct inoculation method.

G. Limitations to the Sterility Test

There are three significant limitations to the sterility test:

1. The statistical power of the USP sterility test is low due to the small sample size relative to the number of units per batch.
2. The growth media have limited ability to grow all potential microbial contaminants, as well as nutritionally deprived or “damaged” microorganisms.
3. There is a pervasive chance of laboratory contamination.

H. Innovations in and Improvements to the Sterility Test

There have been major technological advances in two areas that mitigate some of the limitations of the sterility test. They are the use of isolation chambers for performing the test and the development of new technologies to provide rapid—approaching real time—sterility tests.

Isolation systems are now a reality in the sterility testing suite and aseptic manufacturing area. The use of properly designed and validated isolators for sterility testing can drastically reduce the chance of obtaining a false-positive result. Moreover, the use of isolators for testing should virtually eliminate the human error factor from the equation of possible failure causes. Isolators, their installation, validation, and use have been discussed at length elsewhere.^{38, 52} The second supplement to *USP 24–NF 19* includes a chapter (<1208>) entitled, “Sterility Testing—Validation of Isolator Systems.” This new chapter provides guidance for the validation of isolator systems for use in sterility testing of compendial articles.³⁹

There are a number of newer technologies being explored in an attempt to develop a rapid or real-time sterility test. These are reviewed at length in PDA Technical Report No. 33⁴⁰ and they include the following:

1. *Growth-based technologies*—biochemical assays, headspace pressure, adenosine triphosphate (ATP) bioluminescence, colorimetric detection of CO₂, and impedance (electrical activity)

2. *Viability-based technologies*—solid-phase and flow fluorescence cytometry
3. *Artifact-based technologies*—fatty acid profiles, mass spectrometry, enzyme-linked immunosorbent assay, and fluorescent probe detection
4. *Nucleic acid-based technologies*—DNA probe, ribotyping/molecular typing, and polymerase chain reaction

Two promising rapid microbial enumeration methods that are currently available commercially are the Millipore Microstar system, and the Chemunex ChemScan RDI system (Scan RDI). Although neither of these methods is capable of replacing the sterility test at present, they are discussed to provide examples and details as to how a rapid or real-time sterility test method might be accomplished. The MicroStar rapid detection system (Fig. 2) uses ATP bioluminescence as the base technology to detect cells that have been captured on filter membranes. Individual yeast cells can be detected instantly (within 8 min). However, bacterial isolates cannot be detected at the single cell level. It is necessary to first incubate the membranes to produce microcolonies before enumeration by the Microstar system. This is due to the lower (10- to 1000-fold less) ATP content in the average bacterial cell compared with yeast cells. Thus, the manufacturers maintain that this test will cut by as much as 75% the time required to enumerate bacteria by conventional microbiological methods. The MicroStar system is most suited for water testing; however, because the isolated cells can be rinsed after the filtration step, the test may be amenable to a product sterility test. The degree of utility for this test in replacing the sterility test and its acceptance by regulatory authorities remain to be seen.

The Chemunex Scan RDI uses a base technology of solid-phase cytometry which will only detect intact, viable cells. It uses a nonfluorescent substrate that is enzymatically cleaved by intracellular nonspecific esterase enzymes to activate the substrate to a fluorescent form for detection by laser cytometry.

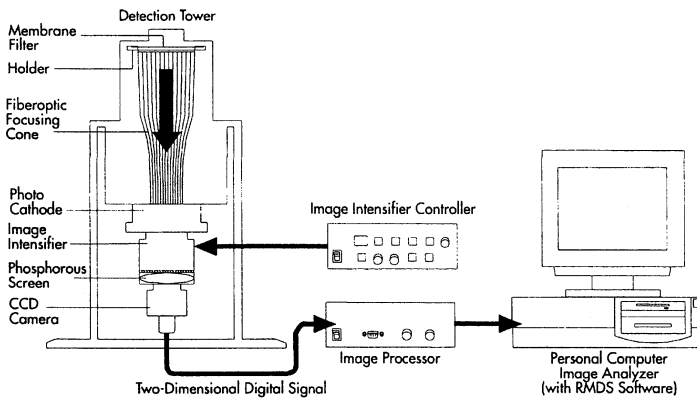

FIGURE 2 Schematic diagram of the Millipore MicroStar microbial enumeration system. The cells are concentrated by membrane filtration and the membrane filter is positioned at the top of the detection tower (upper left). CCD, charge-coupled device; RMDS, rapid micro detection system. (Courtesy of Millipore Corp.)

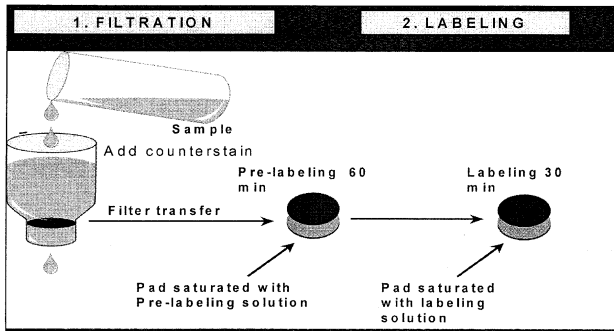

FIGURE 3 Schematic diagram showing the filtration and labeling steps during sample preparation for the Chemunex Scan RDI system. (Courtesy of Chemunex, USA.)

This method can detect single viable fungal or bacterial cells. The procedure for enumeration with this method begins with membrane filtration of the sample followed by washing (Fig. 3). The filter membrane is then directly labeled by applying the substrate that is transported into the cell cytoplasm through the outer cell membrane where it is cleaved by esterase enzymes forming a fluorescent compound. In this way the detection requires a viable cell with an intact cellular membrane. The filter membrane containing the sample is then scanned using a laser in the Chemunex scanner (Fig. 4). This method is already used for pharmaceutical water testing³⁶ and is currently undergoing testing for many other applications including environmental testing and personnel monitoring.³⁷ Tests such as the Scan RDI and Microstar systems would have to pass the rigorous validation requirements set forth in PDA Technical Report No. 33 (for accuracy, linearity, precision, specificity, ruggedness, LOD/LOQ, range, and equivalence to compendial methods) to be considered a viable replacement method for the sterility test.

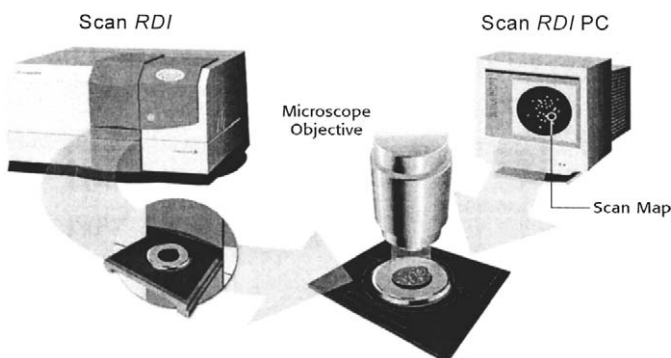

FIGURE 4 Schematic view of the Chemunex Scan RDI system showing sample positioning and scanning within the instrument. (Courtesy of Chemunex, USA.)

XVI. BACTERIAL ENDOTOXIN TESTING

Bacterial endotoxins constitute a type of pyrogen. Pyrogens are toxins that cause fevers when administered intravenously. Bacterial endotoxins are lipopolysaccharides (LPSs), which are a component of the bacterial cell membrane. All bacteria produce endotoxins, but Gram-negative bacteria, owing to the presence of an outer cell membrane, can generate the largest amounts relative to cell number compared with Gram-positive bacteria, which lack an outer membrane). Usually, in the pharmaceutical industry the terms “pyrogen,” “LPS,” and “endotoxin” are used interchangeably, although this is technically not correct. An LPS is a type of endotoxin, which in turn is a type of pyrogen.

It is required that all parenteral dosage forms be tested to be free of pyrogenic contamination. The test can be done two ways: the pyrogen test and the bacterial endotoxin test (BET). The BET has replaced the older, less sensitive, and cumbersome pyrogen test. This test used live rabbits as bioindicators for the presence of pyrogens in injectable drugs. The BET test is now the method of choice although a few countries may still mandate the pyrogen test. For more information on the pyrogen test consult the *USP 24–NF 19* (<151>).³ The BET, as described in *USP 24–NF 19* (<85>), takes advantage of a protein that is present in the cytoplasm of particular cells (amoebocytes) that normally circulate in the blood of the common horseshoe crab (*Limulus polyphemus*). The test is known as the *Limulus* amoebocyte lysate (LAL) test, because it uses the cellular lysate from *Limulus* amoebocytes as the main reagent. The lysate reagent contains a protein that binds to a portion of the LPS molecule, reacts with it, and coagulates it.

A. Basic LAL Test Procedure

The LAL test reagent (as well as complete test kits) can be purchased from various commercial sources and are stored frozen. The reagent is combined with equal volumes of the serially diluted test sample. After incubation at 37°C, the mixture is checked for evidence of a clotting reaction (gel clot), and the test samples are compared to parallel dilutions of a reference endotoxin. The formation of a gel clot indicates the presence of bacterial endotoxins in the sample and the test is considered positive. The test must be properly controlled, all testing materials such as tubes must be pyrogen free, and the temperature, pH, and reaction time must be tightly controlled per USP instructions. Additionally, for BET testing to be valid, the laboratory must be qualified to conduct the LAL test and the amount of variability of the LAL test performed in the laboratory must be determined. The activity (sensitivity) of each lot of lysate must be verified. This is accomplished by testing the lysate versus a range of concentrations of control standard endotoxin (CSE). The CSE is a commercially available standard preparation of endotoxins from *Escherichia coli* ATCC 0113 (also commercially available). The sensitivity of the lysate is confirmed if the gel clot point is within a 2-fold dilution of the CSE.

B. Inhibition and Enhancement Testing

USP 24–NF 19 in the bacterial endotoxin testing section (Chapter 85)³ specifies that the LAL test be validated or qualified for use in the detection of endotoxins for each dosage formulation. Thus, an inhibition and enhancement test must be performed. This will determine if the formulation interacts with the test reagents in ways that may augment or reduce the interaction of the LAL reagent with the endotoxins. This is a critical control as some products may inhibit the clotting reaction and hence might falsely be deemed pyrogen free. On the other hand, some products, especially certain antibiotics such as polymyxin B or other bacteria-derived products (biologicals from bacterial fermentation) may enhance the reaction. It has been estimated that as much as 70% of drug products interfere in some way with the LAL test result.^{41, 42} If inhibition or enhancement occurs, the product may be diluted before testing. This can be done only if the dilution factor necessary to obtain a true LAL result does not exceed the maximum valid dilution (MVD). The MVD is a parameter that is calculated for each product formulation. It is defined as the point beyond which further dilution will not allow detection of an amount of endotoxin that would theoretically cause a pyrogenic reaction in a patient. The MVD takes into account the specific product maximum daily dose and uses a constant for the minimum dose of allowable endotoxin that a patient could withstand without having a fever reaction. Conversely, if the product cannot be diluted to a point where inhibition or enhancement can be controlled, it may be necessary to use the pyrogen test (*USP <151>*). Note that the *USP* chapter on bacterial endotoxin testing (*<85>*) has just recently been harmonized with the *EP* and *JP*. The new, harmonized chapter has been published in the second supplement of *USP 24–NF 19*.³ The implementation date was January 1, 2001.

C. Variations and Alternative LAL Methods

There are several permutations of the basic gel clot LAL test: (1) gel clot end point, (2) chromogenic end point, (3) turbidimetric end point, (4) kinetic-turbidimetric, and (5) kinetic-chromogenic. The manual gel clot test relies on a visual interpretation of the end point (most dilute tube showing gel clot formation). This is subjective and provides only a qualitative result. The other methods use instruments to automatically determine the end point. The chromogenic tests use a modified lysate reagent containing a chromophore that is activated by the lysate–endotoxin reaction. The turbidimetric methods rely on automated optical density measurements of gel formation. The kinetic method goes a step further by automatically tracking either color formation (chromogenic) or turbidity and determining the rate of the endotoxin–lysate interaction. There are huge advantages for using any one of the automated methods, not the least of which are the removal of the human error factor and the ability to process many samples simultaneously. However, automated instruments using microprocessors and data acquisition software must be fully validated. Consult current FDA guidelines for computer/software validation.

D. Endotoxin Contamination in Product

Troubleshooting endotoxin-contaminated products or equipment may become necessary. Generally, the saying “where there is smoke there is fire” is applicable. This means that if endotoxins are detected, the Gram-negative bacterial source of the pyrogens will not be far away. Check the processing equipment for any areas/surfaces that remain moist or hold water (where proper drainage may not be occurring). Concentrate on the cleaning, sanitization, and sterilization procedures. Moist heat sterilization will not destroy bacterial endotoxins although some removal may occur due to dilution from steam condensate. In fact, the autoclave may act to liberate more endotoxins by lysing or otherwise breaking up and dispersing the intact bacterial membranes. Studies of bacterial suspensions of Gram-negative organisms showed that while the number of viable cells decreased over time, the titer of endotoxins detected did not.⁴³ There is no magic formula for calculating amounts of bacterial endotoxins per viable cell count, there are too many variables for this to be possible. However, reports exist stating that as few as 1000 colony forming units (CFU) of *E. coli* per mL was sufficient to cause detectable levels of pyrogenic material (as measured by the rabbit pyrogen test).⁴³

XVII. PARTICULATE MATTER TESTING

The USP specifies that injectable products be 100% inspected to ensure that the product is free from visible foreign particulate matter (<788>). This is crucial because particulate matter in injectable drug products is considered a clinical hazard. Particulate matter has been implicated in the formation of granulomas in various internal organs in rats, as well as embolisms and phlebitis in humans.⁴¹ Pulmonary capillaries (the smallest capillary vessels in the human body) are about 7 μm in size. This is why determination of particles about 7 μm and larger is deemed important.⁴⁴

There are two primary methods for conducting particulate matter analysis, visual inspection, and electronic particle counting. Visual inspections can be done manually or automatically with the aid of automatic inspection machines. Manual inspections are routinely carried out by inspecting the product against a black and then white background using light with an intensity of 100–350 foot-candles at 10 in. distance usually with a magnifying lens (2.5 \times). It has been established that an inspector with normal (20/20) vision will be able to detect particles in the range of 40–50 μm .^{41, 45, 46} The inspectors must be trained and qualified by conducting a test using units known to contain rejectable levels of foreign particulates. Inspections are usually carried out off-line (after filling and any terminal sterilization process) on unlabeled units.

Acceptable quality level (AQL) inspection acceptance criteria are applied to the inspections. Visible foreign particulate matter is considered a critical defect. Thus, AQL levels (the greatest percentage of defective units still acceptable for release) are 0.25–1.0% of the lot size. Consult the American National Standards Institute/American Society for Quality Z1.4 guideline for more detailed information on AQL sampling.⁴⁷ The drawbacks of manual inspection are that it is prone to human error and is subjective.

A. Automatic Container Inspection Machines

There are a number of automatic inspection machines that can be used to replace manual inspections. Generally, these systems use television cameras to detect either white light scattering caused by particulate matter or the shadows created by moving particles in an illuminated vial or ampule. The containers are spun and then abruptly stopped in the camera position while they are illuminated, usually from below. The spinning acts to agitate and release any material that might be adsorbed to the container walls. While under inspection (due to the spinning) the liquid forms a small vortex in the container. The inspection machines can also reject under- or overfilled units because they are programmed to detect the meniscus in a precise zone within the container.

In a comparison study of automatic versus manual inspection, Louer *et al.*⁴⁸ reported a much better rejection rate for known bad ampules (93% vs 54%). However, they also showed that the rate of rejection of “good” ampules by the automatic inspection machine increased significantly. Generally, the automatic visual inspection machines do not detect particles much smaller than the human threshold, but they will help to increase the rate of rejection of truly bad units while eliminating human error.

Because particles having average diameters as small as 7 μm are considered problematic and the normal human eye can discern only down to 40 μm , what is done about the subvisual particles in between?

B. USP Test for Particulate Matter (Subvisual)

The USP includes different tests for the detection, sizing, and enumeration of subvisual particles, e.g., ≥ 10 and ≥ 25 μm . There are two test approaches for particulate matter recognized by the USP. They are automated liquid particle counting either by the light obscuration method or the light (laser) scattering method used mainly for SVPs, and the microscopic method used predominantly for LVPs.

Small-volume injectable products—those with fill volumes of 200 mL or less—are required to pass the USP particulate matter test ($<788>$). This test is carried out using electronic liquid particle counting machines, either the light obscuration type or the light-scattering type. In the former method a beam of light is passed through the test solution and is measured by a photodiode detector. Particles passing through the light path disrupt the light in a size-proportional manner. The HIAC Royco company manufactures light obscuration instruments for particulate matter (PM) testing. The advantages of light obscuration particulate matter determination over other methods such as manual microscopic counting include (1) ease of use, (2) enhanced reproducibility, and (3) relative ease of method automation. Its disadvantages include the following: (1) it uses expensive instrumentation, (2) it does not provide information on the identification of particles, and (3) artifacts such as air bubbles can be counted as particles.

The light-scattering method takes advantage of the behavior of light after it strikes a particle suspended in a clear solution. Measurements of scattered light taken at fixed angles from the direction of the incident light beam are

proportional to the size of the particle. Companies such as MET-One and Climet manufacture laser-based light-scattering instruments for PM testing. These instruments are extremely rapid and can measure particles in as many as six size ranges simultaneously.

The LVP industry has historically used a different particulate matter test, the USP microscopic method. This method involves the use of ultraclean membrane filtration equipment. Twenty-five milliliters of test solution is filtered and the membrane is examined by optical microscopy. The counting is performed using 100× magnification. Particles $\geq 10\ \mu\text{m}$ and $\leq 25\ \mu\text{m}$ are manually sized and counted by highly trained personnel. The counts are adjusted by subtraction from control membrane filter assemblies that were not used to filter product solution. This is the method of choice for emulsions, suspensions, and other nonclear fluid injectable products (including SVPs). This method requires a high degree of expertise for proper performance. It is also extremely time consuming and expensive to perform.

C. Interpretation of Results—Particulate Matter Testing

Results of particulate matter tests are interpreted as following:

- a. For the light obscuration method:
 $\geq 10\ \mu\text{m}$ – 6000 per container $\geq 25\ \mu\text{m}$ – 600 per container
- b. For the microscopic method:
 $\geq 10\ \mu\text{m}$ – 25 per mL $\geq 25\ \mu\text{m}$ – 3 per mL

XVIII. BIOBURDEN TESTING OF PARENTERAL PRODUCT SOLUTION

The term “bioburden” refers to the amount of microbial flora that can be detected on an item or surface or in a solution. The microbial recovery method used depends on the type of material being evaluated. Aerobic bioburden counts in parenteral solutions are obtained by conducting the total aerobic count and total yeast and molds count as specified in the USP microbial limits test (<61>) or a equivalent compendial test. Alternatively, a modified membrane filtration technique can be used to allow filtration of larger volumes of solution to assess bioburden recoveries where sample results are expected to contain a negligible number of microbial flora from the overall solution.

In this section only the bioburden determination of a parenteral product solution for aerobic isolates is discussed and details regarding bioburden testing of facility or equipment surfaces are not included. For parenteral products, bioburden is usually estimated on the unfiltered bulk product solution (UBPS). In this way the test will indicate the total microbial load culminating in the batch solution as a result of the various contributing factors such as all batch ingredients, manual manipulations, and environmental fallout. Testing of filtered bulk parenteral solution either before or after filling into the final container may be done for comparison to the previously tested unfiltered bulk solution or to comply with the directives from European inspectors. All isolates should be identified to the species level whenever possible. The

determination of bioburden in each batch is an important quality control indicator of the formulation process, environment, and materials used for manufacture. Estimation of bioburden after formulation activities is important, as it will demonstrate the effectiveness of all the controls placed on the raw materials and the manufacturing operation. Quantitation of product bioburden is needed to assess whether terminal sterilization methods such as filtration/aseptic filling or terminal heat treatment are appropriately designed and sized. Knowledge of the isolated species will aid in troubleshooting and determining the probable cause of bioburden introduction routes. Results from bioburden testing are also used to verify and/or validate any holding times for unfiltered product solution. The presence of a high bioburden count (especially Gram-negative) will present an endotoxin contamination problem. Although whole microbial cells and spores can be removed by sterilizing grade filtration (0.2 μm), endotoxins are not removed.

A. Bioburden Sampling

Sampling of the UBPS must be carried out using aseptic technique with sterile sample containers and/or sampling devices. The samples should be taken according to a predetermined plan after formulation and all mixing steps have been completed. To avoid potential problems with contamination introduced during sampling, it is advisable to use trained microbiologists from the QC department; however, with proper training manufacturing operators can perform the necessary sampling. It may be possible to fit special sampling devices depending on the type of tank in use. Usually a simple presterilized Y tube fitting spliced into the bottom valve tubing assembly is adequate for sampling. There should be a defined time constraint on delivery of the samples to the QC laboratory with limited refrigeration required for sample storage if sample processing is not immediate because extended storage could influence viability of the resident bioburden.

B. USP Microbial Limit Test

Microbial limit tests, as described in *USP 24–NF 19* (<61>)³ provide the information necessary to conduct bioburden counts by quantitative estimations of viable aerobic microorganisms in pharmaceutical articles, raw materials, and finished dosage forms. Consult the EP or JP for any differences in these methods from those of the USP. Note that USP (<61>) is currently under revision and that the next version will be fully harmonized between the USP, EP, and JP. The microbial limit test comprises the total aerobic bacterial (microbial) count (TAC), the total combined yeasts and molds count (TYMC), and tests for indicator organisms. Bioburden tests are also referred to as total viable counts. This test estimates the total number of viable (culturable) aerobic microorganisms in various items including parenteral UBPS. The total viable count is obtained by adding the counts from the TAC and the TYMC.

C. Conducting TAC and TYMC by Pour-Plate Method

The TAC can be conducted using a number of microbiological methods. These are the pour-plate, membrane filtration, and multiple tube methods. The TYMC is conducted by using either the pour-plate or membrane filtration method. The TAC for bioburden is performed by adding 10 g, 10 mL, or 10 units in SCD broth or lactose broth to make 100 mL. Aliquots of this sample preparation are transferred into four standard size (15 × 100 mm) Petri dishes. Into two of the plates 15–20 mL of molten SCD agar is poured, and into the other two the same volume of Sabouraud dextrose agar (SAB) agar is poured.

D. Conducting TAC and TYMC by Membrane Filtration Method

Because many parenteral solutions are preserved or are expected to have a negligible bioburden level, a larger sample than that specified in the current USP guidelines may be desired, e.g., up to 1 L, to detect any resident aerobic microbial flora. In this case, the entire volume of test solution would be membrane filtered in equivalent portions and rinsed and then the membrane would be aseptically transferred to the appropriate test agar and incubated as described below. The membrane filtration method is considered more sensitive than the pour-plate method and may be simpler to perform as well.⁴⁹ Bioburden is estimated by the membrane filtration method in the following way. Suspend 10 g or 10 mL of product into 4 × 100 mL volumes of either sterile phosphate buffer (USP), pH 7.2, or sterile 0.1% peptone water. These sample preparations are filtered through 0.45- μ m mixed cellulose ester (50 mm) filter membranes. Filtration is followed by three 100-mL rinses in the same sterile buffer used to prepare the sample. The filters are then aseptically transferred onto the surface of SCD agar plates. For the TYMC, the filter is placed on SAB agar. The plates are incubated for 48–72 h at 30–35 °C (SCD) and for 5–7 days at 20–25 °C (SAB). Colonies are counted and numbers are expressed as colony-forming units per 10 g or 10 mL of product sample. The TAC portion of the bioburden test can also be carried out using the multiple tube method, also known as the most probable number method.

E. Preparatory Testing (Bioburden Recovery Validation)

For the bioburden results to be considered valid, it is important to demonstrate that the product does not exhibit any antimicrobial activity toward the product bioburden. The chapter in *USP 24–NF 19* on microbial limits testing states: “The validity of the results of the tests set forth in this chapter rests largely upon the adequacy of a demonstration that the test specimens to which they are applied do not, of themselves, inhibit the multiplication under the test conditions of microorganisms that may be present.”³ Therefore, the product solution to be tested must be inoculated with low levels (between 10 and 100 CFU/mL) of various challenge organisms. The challenge organisms can be obtained from the American Type Culture Collection (ATCC). The USP-specified microorganisms are *Staphylococcus aureus* ATCC 6538, *Pseudomonas aeruginosa* ATCC 9027, *Escherichia coli* ATCC 8739, *Salmonella*

species (no type culture recommended), *Candida albicans* ATCC 10231, and *Aspergillus niger* ATCC 16404. Other organisms, such as any product or manufacturing environmental isolates, may be included in the challenge test in addition to the ones mentioned above. If the formulation or a preservative therein prevents the subsequent recovery of challenge organisms, the agent should be eliminated by dilution or chemically neutralized.

F. Setting and Using Bioburden Limits

Parenteral product manufacturers should have preset limits on product (unfiltered) bioburden based upon in-house sample data. Generally, alert and action limits are set for each product or class of products. If the action limit is exceeded, the resulting action should be rejection of the batch. Products can be grouped according to intrinsic characteristics such as whether the product is terminally sterilized or aseptically filled, the presence or absence of preservatives in the formulation, and the growth-promoting capability of the excipients or finished product formulation. If no bioburden data exist for a given product or grouping, it is common practice to determine baseline bioburden levels before permanent limits are set. For new products this is usually done during the development or validation batch production stage, provided the final scale and facility are being used. If the product is to be marketed in the European Union (EU), the EP states specific unfiltered bulk product solution (UBPS) limits for terminally sterilized and aseptically filled products. European inspectors tend to be keener on product bioburden than their U.S. counterparts, even if the product is terminally sterilized. Based upon current practice, for aseptically filled products, the UBPS bioburden limit is 10 CFU/100 mL and for terminally sterilized products, this limit is 100 CFU/100 mL. For products marketed in the EU, it is recommended that UBPS bioburden levels remain below these limits for the duration of any proposed product holding periods. In addition, for these products it may be necessary to collect a postfiltration, presterilization sample of filled units for bioburden determination. Finally, a trend analysis system for bioburden results on a product-by-product basis should be put into place. Trend analysis should be carried out by a specially designated interdisciplinary team on a quarterly or semiannual basis. Any upward trends, even if within the alert limits, should trigger an investigation to determine the cause before a larger problem results.

G. Prevention of Bioburden Contamination in Parenteral Formulation Areas

Wherever possible, facility surfaces and equipment should be cleaned in a manner that precludes the accumulation of water for any length of time. Equipment should be thoroughly dried with clean compressed air or dry nitrogen gas before storage. Product hoses and tubing are stored in a way that will facilitate drainage. Strict limits are placed on the product contact “hold dirty” periods so that there will be no chance for product residues to dry on equipment surfaces, which may promote microbial growth. Equipment, once cleaned, should be physically separated from nonclean areas or equipment to avoid resoiling. All unfiltered product hold times must be challenged to assess their appropriateness from a microbial cleanliness perspective.

XIX. INTRODUCTION TO CLEANING VALIDATION

The Code of Federal Regulations states in Section 211.67, Equipment Cleaning and Maintenance, "Written procedures shall be established and followed for cleaning and maintenance of equipment, including utensils, used in the manufacture, processing, packing, or holding of a drug product."⁴⁹

Cleaning validations prove the effectiveness of the cleaning procedures used for cleaning product contact equipment. These can be accomplished by analyzing swab and/or rinse samples for chemical residues. Along with swab/rinse samples, air impingers can be used as a verification that no cross contamination occurred during filling due to the potential aerosolization of the product. Validation usually consists of three consecutive runs. Additionally, for injectable products, microbial monitoring should be included as part of the cleaning validation program.

Before execution of the cleaning validation, the cleaning procedures should be in the form of approved standard operating procedures (SOPs). These procedures should be detailed enough to be reproducible. Parameters such as detergent type, detergent concentration, exposure time, rinse temperature/rinse time, and water pressure/flow rate should be included in the procedure. The final rinse is usually performed with water for injection (WFI). The production operators should be trained in these procedures and their training should be documented.

XX. SWAB SELECTION (RECOVERY AND COMPATABILITY STUDIES)

Problems such as swab recoverability or interference with adhesive materials are commonly encountered during the swab selection process. It is imperative that the swab selected be compatible with the diluent, the detergents, and the chemical (active/degradant) and it cannot cause interference with the method used for residue analysis, typically HPLC and/or TOC. A swab recovery study is required for determining the acceptability of a swab. This is performed by spiking the swab with known quantities of the various chemicals under evaluation for potential carryover. The swabs need to be analyzed by the validated method to be used in the cleaning validation studies. An acceptable level of recovery should be no less than 70% and a correction factor needs to be included in final residue calculations.

For microbial monitoring, sterile swabs also need to be selected. Similar swab recovery studies are performed this time with microorganisms instead of chemical agents.

XXI. TECHNICIAN QUALIFICATION

Some problems routinely seen during swabbing include inappropriate use of swabs, contamination of swabs during sampling, and poor swabbing technique. The latter should be identified and corrected before the validation is

performed. The swab technician, typically from production or the laboratory, needs to be qualified in the swabbing procedure to ensure reproducible swabbing. The swabbing technique needs to be outlined in great detail.

For example, swab an $x \text{ cm}^2$ square area by the following procedure:

- Swab in a horizontal direction to the right in four straight motions
- Turn the swab over and swab vertically downward in four straight motions
- Turn the swab over again and swab horizontally to the left in four straight motions
- Place the swab in a screw top test tube with y amount of diluent
- Store sample and test per the approved validated methods

To qualify the swab technician, place a known amount of API, detergent, or other chemical (degradant) under evaluation onto a plate of $x \text{ cm}^2$ surface area consisting of the same surface type as the equipment to be swabbed. If the production equipment consists of multiple surface types, such as stainless steel, glass and plastic, then all these surface types need to be included in the qualification. The technician should obtain approximately the same recovery as the recovery determined from the initial swab selection recovery studies (swab spiking).

XXII. SAMPLING

Both swab and rinse samples should be taken for chemical residue analysis and microbial contamination studies. The numbers of samples and locations of swab samples should be outlined in a table for each piece of equipment. The critical sites, the most difficult-to-clean locations, should be selected for each piece of equipment, for example, the bottom of a tank under the mixer blades. Diagrams and/or photographs denoting the swab locations for both chemical (residue carryover) and microbial samples should be included in the protocol. It is necessary to define in the protocol (discussed later) how and when the rinse samples are to be taken. Also included are positive and negative controls during sampling. Air impingers should be used to verify that there has been no cross contamination of rooms or air handlers due to aerosolization of the product. Most samples should not be held for longer than 24 h before testing, but the actual sample stability must be determined during the method validation.

Worst-case conditions should be considered when the validation is conducted. If production equipment can be held in a “dirty state” over an extended holiday weekend (i.e., 4 days), then the cleaning validation should challenge this worst-case condition. Also, the period of time a clean piece of equipment can be held before reuse should be challenged. If there are ranges associated with the cleaning procedures, then these worst-case parameters, upper and lower limits, should be targeted during the validation. Examples of parameters include the lowest water temperature, lowest water pressure, and fewest number of rinses allowed by the cleaning procedures.

XXIII. ACCEPTANCE CRITERIA

Residue/contamination limits can be determined in various ways although this can be the most challenging part of the validation. As outlined in PDA Technical Report No. 29, "Points to Consider for Cleaning Validation,"⁵⁰ some commonly used approaches are to base the maximum allowable carryover (MAC) on

1. the medical/pharmacological potency of the product *or*
2. the toxicity of the residue *or*
3. the analytical method's limit of detection.

The reasoning for selection of the approach and calculation of the MAC should be logical and based on sound scientific rationale. Once determined, the MAC should be distributed among the different pieces of equipment used in the manufacture of the product, such as a compounding tank, a surge tank, or filling nozzles.

A typical pharmacological potency-based formula used to evaluate the total MAC for all equipment used in the production process is

$$MAC = \frac{(TD) (BS) (SF)}{LDD}$$

where MAC is the maximum allowable carryover, TD is a single therapeutic dose, BS is the batch size of the next product to be manufactured in the same equipment, SF is the safety factor (Table 1), and LDD is the largest daily dose of the next product to be manufactured in the same equipment.

A limit based on the toxicity of the residue can be evaluated by the ADI/NOEL equation

$$NOEL = (LD_{50}) (\text{empirical factor})$$

$$ADI = (NOEL) (AAW) (SF)$$

where NOEL is no observed effect level, LD₅₀ is lethal dose for 50% of animal population in an intravenous route toxicity study, empirical factor is derived from an animal model developed by Layton *et al.*, ADI is acceptable daily intake, AAW is average adult weight, and SF is safety factor.

The maximum allowable limit would then be

$$MAC = \frac{(ADI) (B)}{R}$$

TABLE I Safety Factor

Approach	Typically applicable to
1/10 to 1/100 of a normal daily dose	Topical products
1/100 to 1/1,000 of a normal daily dose	Oral products
1/1,000 to 1/10,000 of a normal daily dose	Injections, ophthalmic products
1/10,000 to 1/100,00 of a normal daily dose	Research, investigational products

where B is the smallest batch size of any subsequent product and R is the largest daily dose of any product manufactured in the same equipment.

Another approach is to use the sensitivity of an analytical method for determining the acceptance criteria limits. In this case, either the LOD or LOQ can be used as the acceptable residue limit. If the results reported for the swab and rinse samples are less than the LOD or LOQ, the sensitivity limits can be used to calculate the MAC present.

Note that a draft EU document III/5581/992 “Validation Master Plan Design Qualification, Installation and Operational Qualification, Non-Sterile Process Validation, Cleaning Validation”⁵¹ states that “for certain allergenic ingredients, penicillins, cephalosporins, or potent steroids and cytotoxics, the limit should be below the limit of detection by the best available analytical method.”

Microbial limits should be based on USP WFI limits for endotoxin and the detection limits of the bioburden method. Consideration should be given to where the manufacturing equipment resides, for example, class 10,000 for compounding tanks and class 100 for surge tanks, when scientifically sound microbial limits are determined.

XXIV. METHODS OF ANALYSIS

These methods, typically HPLC, must detect the chemical under evaluation at or below the acceptance criteria limits. The methods must be validated with samples from the swabs, rinses, and air impingers to prove limit of detection, specificity, range, sample preparation, sample stability, and reproducibility. A quick method, like UV spectrophotometry or conductivity, should also be developed and validated for the routine cleaning verification of wash rinse samples.

The LAL and bioburden methods must be developed to isolate and quantify bacteria and endotoxins. Rinse samples are usually tested for bacterial endotoxin (LAL) and swab and rinse samples are tested for bioburden. Isolated microorganisms should be identified to an appropriate level, whenever possible.

XXV. GROUPING/MATRIX APPROACH

Product grouping may be considered for products using the same manufacturing equipment and cleaning procedures. Instead of performing product-specific cleaning validations, a worst-case “product” approach may be considered. The most difficult-to-clean product is selected as the worst case based on factors such as toxicity, solubility, and viscosity. Once the cleaning validation is found acceptable for this worst-case product, results for other products compared and grouped against the worst case can be determined to be acceptable. FDA and European Regulatory bodies find this approach acceptable.

Note that the EU draft document III/5581/99² “Validation Master Plan Design Qualification, Installation and Operational Qualification, Non-Sterile Process Validation, Cleaning Validation” finds this practice acceptable.

Cleaning procedures for products and processes which are very similar, do not need to be individually validated. It is considered acceptable to select a representative range of similar products and processes concerned and to justify a validation programme which addresses the critical issues relating to the selected products and processes. A single validation study under consideration of the 'worst case' can then be carried out which takes account of the relevant criteria. This practice is termed 'bracketing.'⁴⁸

XXVI. VALIDATION PROTOCOL

Before the cleaning validation is conducted, a protocol should be developed and approved by quality control and operations management personnel. The protocol should include the following:

- Purpose/objective
- Equipment list with diagrams and/or photographs denoting swab locations
- Cleaning procedures: SOP references with the effective dates
- Sampling procedures: outlining swab technique and rinse sample collection procedure
- Analytical methods
- Microbial methods
- Acceptance criteria: including rationale for MAC determination
- Attachments: cleaning SOPs, swab selection and recovery studies, swab technician qualification studies, and method validations

XXVII. VALIDATION REPORT

Once the validation is complete, a final report summarizing the acceptability or unacceptability of the cleaning procedures must be written. It should include a summary of the swab, rinse, and air impinger data supporting the adherence to the MAC acceptance criteria and an explanation of any variances or out of specification results. The raw data should be attached to the final report.

XXVII. SUMMARY

This chapter covers the aspects of pharmaceutical analysis that are required to monitor the quality of parenteral (injectable) products from development stage through to the marketing phase. Emphasis is placed on analytical methods or techniques that are either unique to or require some modification to be applicable to this class of pharmaceutical product. After a brief introduction to the liquid injectable dosage form, the development process is discussed with emphasis on in-process analysis and analysis of the bulk drug substance, excipients, and final dosage form. Chemical analysis of parenteral products is accomplished predominantly via use of HPLC. Although covered in another chapter of this book, attention is given to the development and validation of analytical methods for injectables. Newer technologies, such as near-infrared

spectroscopy, their potential applications, and actual applications, are presented. Because injectables are labeled sterile, the most unique tests that must be carried out are the microbiological tests. The chapter examines in depth the sterility test, microbial limit tests (bioburden tests), bacterial endotoxin test, and particulate matter test. There is a section on rapid methods that may in the future be applicable to (near) real-time sterility test methods. The microbiological portion of the chapter is written with the nonmicrobiologist in mind with sections covering microbiological troubleshooting of manufacturing operations. Lastly, a detailed presentation of cleaning validation, an increasingly critical aspect of pharmaceutical analysis, is given with practical examples including all necessary calculations.

REFERENCES

1. Sweetana, S. and Akers, M. J. Solubility principles and practices for parenteral dosage form development. *PDA J. Pharm. Sci. Technol.* 50:330–342, 1996.
2. Avis, K. E., Lieberman, H. A., and Lachman, L. Eds. *Pharmaceutical Dosage Forms: Parenteral Medications*, Vols. I, II, and III. Marcel Dekker, New York, 1992.
3. Physical Tests <661> Containers. In *USP 24-NF 19*, pp. 1930–1932. United States Pharmacopoeial Convention, Rockville, MD, 2000.
4. Abendroth, R. P. and Clark, R. N. Glass containers for parenterals. In *Pharmaceutical Dosage Forms: Parenteral Medications* (K. E. Avis, H. A. Lieberman, and L. Lachman, Eds.), Vol. I, pp. 173–248. Marcel Dekker, New York, 1992.
5. Anes, J. M., Nase, R. S., and White, C. H. Use of plastics for parenteral packaging. In *Pharmaceutical Dosage Forms: Parenteral Medications* (K. E. Avis, H. A. Lieberman, and L. Lachman, Eds.), Vol. I, pp. 173–248. Marcel Dekker, New York, 1992.
6. Smith, E. J. and Nash, R. J. Elastomeric closures for parenterals. In *Pharmaceutical Dosage Forms: Parenteral Medications* (K. E. Avis, H. A. Lieberman, and L. Lachman, Eds.), Vol. I, pp. 173–248. Marcel Dekker, New York, 1992.
7. Boehlert, J. Assay development in stability test methods. *Drug Dev. Ind. Pharm.* 10:1343–1371, 1984.
8. Chafetz, L. Stability indicating assay methods for drugs and their dosage forms. *J. Pharm. Sci.* 60:335–345, 1971.
9. Weisner, W. Developing analytical methods for stability testing. *Pharm. Tech.* 20–29, 1998.
10. Andrews, R. W. and Richardson, H. Effect of spectral resolution, detector linearity and chromatographic resolution on peak purity calculations. *J. Chromatogr.* 683:3–8, 1994.
11. Guiffre, R. The use of diode-array detectors in the pharmaceutical industry. *Chrom. Sci. Ser.* 62:163–197, 1993.
12. Sievert, H. J. P. and Drouen, A. C. H. J. Spectral matching and peak purity. *Chrom. Sci. Ser.* 62:51–126, 1993.
13. Sturgeon, R. J., Athnikar, N. K., Harbison, H. A., Henry, R. S., Jurgens, R. W., and Welco, A. D. *J. Parenter. Drug Assoc.* 34:175–182, 1980.
14. *Dextrose Injection, Official Monograph*, p. 532. United States Pharmacopoeial Convention, Rockville, MD, 2000.
15. Strickley, R. G. Parenteral formulations of small molecule therapeutics marketed in the United States. *PDA J. Pharm. Sci. Technol.* 53:324–349, 1999.
16. Marbach, E. P. and Well, M. H. Rapid enzymatic measurement of blood lactate and pyruvate. *Clin. Chem.* 13:314–325, 1967.
17. Barhan, D. and Trinder, P. An improved color reagent for the determination of blood glucose by the oxidase system. *Analyst.* 97:142–152, 1972.
18. Ulbricht, R. J., Northup, S. J., and Thomas, J. A. A review of 5-hydroxymethylfurfural in parenteral solutions. *Fundam. Appl. Toxicol.* 4:843–853, 1984.
19. International Conference on Harmonization. Guidance for industry. Q3B Impurities in new drug products, November 1996.

20. Stenlake, J. B., Waigh, R. D., Dewar, G. H., Dhar, N. C., Hughes, R., Chapple, D. J., and Cokker, G. G. Biodegradable neuromuscular blocking agents. Part 4. Atracurium besylate and related polyalkylene di-esters. *Eur. J. Med. Chem.* 16:515–524, 1981.
21. Poole, C. F. and Poole, S. K. Modern thin layer chromatography. *Anal. Chem.* 61:1257A–1269A, 1989.
22. Salo, J. P. and Salomies, H. High performance thin-layer chromatographic analysis of hydrolyzed tinidazole solutions. I. Development and validation of method. *J. Pharm. Biomed. Anal.* 14:1261–1266, 1996.
23. Burns, D. A. and Ciurczak, E. W. NIR analysis of pharmaceuticals. In *Handbook of near-infrared analysis*, Practical Spectroscopy Series, Vol. 13, pp. 549–563, 1992.
24. Last, I. R. and Prebble, K. A. Suitability of near-infrared methods for the determination of moisture in a freeze-dried injection product containing different amounts of active ingredient. *J. Pharm. Biomed. Anal.* 11:1071–1076, 1993.
25. Plugge, W. and Van Der Vlies, C. Near-infrared spectroscopy as an alternative to assess compliance of ampicillin trihydrate with compendial specifications. *J. Pharm. Biomed. Anal.* 11:435–442, 1993.
26. International Conference on Harmonization. Guidance for industry. Q2B Validation of analytical procedures: methodology, November 1996.
27. Validation of compendial methods. Section 1225. In *USP 24–NF 19*, pp. 2149–2152. United States Pharmacopoeial Convention, Rockville, MD, 2000.
28. Snyder, L. R., Kirkland, J. J., and Glajch, J. Completing the method: validation and transfer. In *Practical HPLC Method Development*, pp. 685–713. John Wiley & Sons, New York, 1997.
29. Berglund, M., Bystroem, K., and Persson, B. Screening chemical and physical stability of drug substances. *J. Pharm. Biomed. Anal.* 8:639–643, 1990.
30. Stewart, C. W., Jr. The use of liquid chromatography–mass spectrometry to demonstrate method specificity. *Am. Lab.* 32:18–20, 2000.
31. Kirsch, R. B. Validation of analytical methods used in pharmaceutical cleaning assessment and validation. *Pharm. Tech.* 40–46, 1998.
32. *Guide to Inspections, Validation of Cleaning Processes*. Food and Drug Administration, Office of Regulatory Affairs, Rockville, MD, 1993.
33. Murthy, S. S. and Brittain, H. Stability of Revex[®], nalmefene hydrochloride injection, in injectable solutions. *J. Pharm. Biomed. Anal.* 15:221–226, 1996.
34. Gold, D. H. Validation, why, what, when, how much. *PDA J. Pharm. Sci. Technol.* 50:55–60, 1996.
35. U.S. Food and Drug Administration. Guideline on aseptic processing. *Fed. Regist.* 53:5044, 1987.
36. *Difco Manual*, 11th ed. Difco Laboratories, Division of Becton Dickinson and Company, Sparks, MD, 1998.
37. Jones, D. L., Brailsford, M. A., and Drocourt, J.-L. Solid phase, laser-scanning cytometry: a new two-hour method for the enumeration of microorganisms in pharmaceutical water. *Pharm. Forum* 25:7626–7645, 1999.
38. Farquaharson, G. and Whyte, W. Isolators and barrier devices in pharmaceutical manufacturing. *PDA J. Pharm. Sci. Technol.* 54(1), 2000.
39. *USP 24–NF 19, Second Supplement*, pp. 2875–2879. United States Pharmacopoeial Convention, Rockville, MD, 2000.
40. Evaluation, validation and implementation of new microbiological testing methods. Technical Report No. 33. *PDA J. Pharm. Sci. Technol.* 54(3, Suppl. TR33), 2000.
41. Akers, M. J. *Sterility Testing, Parenteral Quality Control, Sterility, Pyrogen, Particulate and Package Integrity Testing*, 2nd ed. (J. R. Robinson, Ed.), pp. 1–94. Marcel Dekker, New York, 1994.
42. Cooper, J. F. Resolving LAL test interferences. *J. Parenter. Sci. Technol.* 44:19–21, 1990.
43. Pearson, F. C., III. *Endotoxin, Pyrogen Endotoxins, LAL Testing, and Depyrogenation*, pp. 30–33. Marcel Dekker, New York, 1985.
44. Duma, R. J., Akers, M. J., and Turco, S. Parenteral drug administration: routes, precautions, problems, and complications. In *Pharmaceutical Dosage Forms: Parenteral Medications*, 2nd ed. (K. E. Avis, L. Lachman, and H. Lieberman, Eds.). Marcel Dekker, New York, 1991.
45. Brewer, J. H. and Dunning, J. H. F. An *in vitro* and *in vivo* study of glass particles in ampuls. *J. Am. Pharm. Assoc.* 36:289, 1947.

46. Leclarasamee, N., Howard, S. A., and Baldwin, H. J. Visible particle limits in small-volume parenterals. *J. Parenter. Drug Assoc.* 34:167–174, 1980.
47. American National Standard: *Sampling Procedures and Tables for Inspection by Attributes*. American Society for Quality, Milwaukee, 1993.
48. Louer, R. C., Russoman, J. A., and Rasanen, P. R. Detection of particulate matter in parenteral solutions by image projection: A concept and its feasibility. *Bull. Parenter. Drug Assoc.* 25:54, 1971.
49. Equipment cleaning and maintenance. Code of Federal Regulations, Food and Drugs, Title 21, Part 211.67. US Government Printing Office, Washington, DC.
50. Points to consider for cleaning validation. PDA Technical Report No. 29. Suppl. Vol. 52, No. 6, 1998.
51. Validation master plan design qualification, installation and operational qualification, non-sterile process validation, cleaning validation. EU document III/5581/99². European Commission, Working Party on Control of Medicines and Inspections, Brussels, 1999.
52. Akers, J. and Agalloco, J. Isolators—validation and sound scientific judgement. *PDA J. Pharm. Sci. Technol.* 54(2), 2000.
53. Clontz, L. *Microbial Limit and Bioburden Tests, Validation Approaches and Global Requirements*, p. 66. Interpharm Press, Buffalo Grove, IL, 1998.
54. Layton, D. W., Mallon, B. J., Rosenblatt, D. H., and Small, M. I. *Reg. Tox. Pharm.* 7:96–112, 1987.

This Page Intentionally Left Blank

8

NEW DRUG DELIVERY SYSTEMS

DAVID C. PANG

American Association of Pharmaceutical Scientists, Arlington, Virginia 22201

- I. INTRODUCTION
- II. ORAL DRUG DELIVERY
 - A. Stomach
 - B. Colon
- III. DIRECT DRUG DELIVERY
 - A. Nasal Route
 - B. Rectum
- IV. DERMATOLOGICAL DELIVERY SYSTEM
- V. TUMOR-TARGETED DRUG DELIVERY SYSTEMS
- VI. BIODEGRADABLE DRUG DELIVERY SYSTEM
 - A. Characteristics of Nanoparticles
 - B. In Vivo Applications
- VII. PROTEIN DRUG DELIVERY SYSTEM
 - A. Oral Route
 - B. Pulmonary Route
 - C. Rectal Route
 - D. Dermatological Route
 - E. Ocular Route
- VIII. DEVICES
 - A. Needle-Free Injectors
 - B. Implants
 - C. Inhalers
- IX. SUMMARY
- REFERENCES

I. INTRODUCTION

Pharmaceuticals are convenient and cost effective for the treatment of diseases. Their usefulness is enhanced by the fact that taking medication is a process easily accomplished by patients without intensive supervision from physicians and pharmacists. This relative ease of administration has to be credited to the enormous amounts of time and effort spent by pharmaceutical scientists to formulate and validate the medication. Drug delivery constitutes one of the major components in the drug development process, in addition to the assurance that the medication is efficacious and free of serious side effects.¹⁻³ Pharmaceutical scientists have to consider the best route of administration, the target site of action, and the formulation, stability, and bioavailability of the drug. The most obvious route of administration of drugs is through the oral cavity or in some cases through the rectum into the gastrointestinal tract. Other routes that patients can handle easily are through the nose, skin, and eye. Drug

delivery via intravenous, intramuscular, subcutaneous, and peritoneal administration requires training, supervision, and possibly skilled personnel. New and promising drug delivery systems have been created and modified to ensure that drugs are delivered to the appropriate targets of action in the body without major complications.

II. ORAL DRUG DELIVERY

The potential sites for absorption of drugs in the gastrointestinal tract are the buccal cavity, stomach, small and large intestines, and rectum. The small intestine is a common area for drug absorption. Once absorbed by the gastrointestinal tract, a drug is channeled through the portal vein to the liver before gaining access to the systemic circulation for delivery to its site of action. The presence of degradative enzymes along the gastrointestinal tract and the acidic environment in the stomach constitute some of the barriers for delivery of drugs from the oral cavity. Low oral bioavailability of a drug is usually caused by relative insolubility in water, poor intestinal permeability, or biodegradation in the upper portion of the digestive tract. Because the liver is another major site of biotransformation of drugs, the bioavailability of some drugs may not be as high as expected. Administration of a prodrug that makes use of the biotransformation process in the intestine and liver can greatly enhance the availability of the drug at the site of action. A high proportion of drug administered in the rectum is absorbed and drained into the venous circulation, thereby bypassing the initial biotransformation step. Unless modified in some way, drugs such as hormones, proteins, small peptides, and some antibiotics are not suitable for this route of administration.

One way to deliver drugs into the gastrointestinal tract is in the form of a remote drug delivery capsule, which is a nondisintegrating remote control device with a volume less than 1 mL. The capsule is made up of outer and inner sleeves with a series of predrilled open slots. The slots are not aligned following introduction of the drug inside the capsule. The capsule is then swallowed by the patient. At the appropriate time, a remote electronic signal will cause the series of slots in the inner and outer sleeves of the capsule to align and release the drug. With the use of indium-111 and technetium-99m, the transit of the capsule through the gastrointestinal tract was followed with gamma scintigraphy in human volunteers to determine its capability of drug release at designated sites. Because of its relative large dimensions (35 mm × 10 mm), the capsule took a slightly longer time (approximately 1.5 h) to be cleared from the stomach than that of other nondisintegrating systems. The times for the capsule to reach the small and the large intestines were also noted. About 30 h were needed to traverse the gastrointestinal tract in a human volunteer. The contents of the capsules were successfully released by electronic stimuli when they reached the intended site either in the stomach, early small bowel, distal small bowel, or colon.

A. Stomach

Helicobacter pylori has been demonstrated to be the cause of gastric ulcers. It has been established that a localized dose of tetracycline and metronidazole in the stomach is essential for the eradication of the bacteria. The challenge for the treatment of this condition is to design a system that constantly delivers antibiotics with prolonged gastric retention time. A hydrophilic triple-layer asymmetric configuration delivery system containing bismuth, tetracycline, and metronidazole, with a floating feature was generated for this purpose. The major excipients were sodium bicarbonate, poly(ethylene oxide), and lactose. On introduction of the triple-drug system to dissolution medium, bismuth was released instantly, while the release of tetracycline and metronidazole followed zero-order kinetics over a period of 5 to 7 h. The system also floated 30 min after immersion in the dissolution medium and remained floating until all the antibiotics were released. The floating feature is especially important in that it delays gastric emptying.

B. Colon

Some idiopathic inflammatory diseases, e.g., Crohn's disease, exhibit focal, often transmural, lesions in the small intestine and/or colon with extraintestinal manifestations. For the treatment of these diseases, it may be necessary to deliver dosage forms that release drugs only within the colon and without loss in the upper gastrointestinal tract. One way is to prepare water-insoluble polymers that are stable in the stomach and small intestine, but degrade in the reductive environment of the large intestines. Representative polymers can be prepared by reaction of an α, ω -diaminopolyether with a di-*N*-oxysuccinimidylester of 3,3'-dithiodipropionic acid. The polymer is used to coat drug-containing pellets, e.g., Eudragit E100. When the polymer is degraded in the large intestine, the drug is released. On administration to human volunteers, it was found that the time for the initial degradation of the polymer from the drug-containing pellets ranged from 7.7 to 10.1 h and occurred in the proximal and transverse colon. It was also noted that the time required for drug from the colon-specific delivery system to reach its destination was greatly slowed by the presence of food in the gastrointestinal tract. Time-lapse sequential scintigraphic imaging over 24 h in human volunteers showed that polymer disintegration and hence drug release would not occur until approximately 5 h after gastric emptying in fasted or fed subjects.

Another colon-specific delivery system consists of core beads made up of microcrystalline cellulose, Carbopol, and a drug. These beads are coated sequentially with a controlled-release film of Eudragit RS30D or Aquacoat and an enteric film of Eudragit L30D. Carbopol is a binder, which is sensitive to pH and swells in the higher pH region of the intestine and colon. The swelling ruptures the film coating, resulting in the release of the drug. A dissolution test indicated that there was slow release of the drug at pH values less than 6.5, but the release at pH greater than 6.5 was rapid.

III. DIRECT DRUG DELIVERY

The nasal cavity and the rectum are unique sites of drug delivery in that the drugs will be absorbed directly into the bloodstream. These routes have been explored for possible use.

A. Nasal Route

Ondansetron (OND), a 5-hydroxytryptamine₃ receptor antagonist, has been used for prevention of nausea and vomiting associated with emetogenic cancer therapy.⁴ In view of the condition being treated, intravenous and oral dosage forms of OND may be inconvenient and/or unfeasible for specific patient populations. The nasal cavity can be a potential alternative route. A dose of 1 mg/kg OND (Zofran injection, 2 mg/mL) was administered to male Sprague–Dawley rats intravenously or intranasally. The peak plasma level of OND was attained within 10 min after application to the nasal mucosa of the rat. The plasma concentration–time profiles for nasal administration were comparable to those for intravenous injection, indicating complete absorption via the nasal route. The terminal elimination half-lives of the two routes of administration were also similar. The nasal administration route of OND was superior to the oral route (in humans, the oral absolute bioavailability is only 56% and the time to peak concentration is 1.0–2.1 h) and as effective as the intravenous route.

Cystic fibrosis is a hereditary disorder caused by mutation in the cystic fibrosis transmembrane conductance regulator gene that encodes a cyclic adenosine monophosphate-regulated chloride channel.⁵ Defects in chloride ion transport in the airway epithelia lead to abnormal airway secretions, impaired mucociliary clearance, chronic bacterial infection, bronchiectasis, and premature death. Delivery of the cystic fibrosis transmembrane conductance regulator cDNA by adenovirus vectors or the plasmid–liposome complex resulted in transient correction of the defects in patients with cystic fibrosis. Formulations of cationic lipid–DNA complexes for aerosol delivery are being explored to improve on the gene therapy approach.

B. Rectum

For drugs that have poor oral bioavailability, rectal administration of prodrugs can increase their absorption. For example, nalbuphine is an analgesic with potency approximately 0.5–0.9 that of morphine. It is used for the relief of moderate to severe pain from a variety of causes, e.g., surgery, trauma, cancer, kidney, or biliary colic pain. Oral bioavailability of nalbuphine was poor, e.g., around 6% in experimental dogs. Rectal administration of nalbuphine-3-acetylsalicylate in the same animals enhanced the bioavailability 4- to 5-fold to around 28%. In addition, the plasma half-life of nalbuphine after rectal administration of the prodrug was prolonged.

IV. DERMATOLOGICAL DELIVERY SYSTEM

The skin constitutes an inviting area for the delivery of drugs. However, due to its function as a barrier to unwelcome external influence, the skin presents a formidable challenge to researchers for drug delivery. Experiments were performed to increase drug penetration into the skin by the application of short, high-voltage (100 V) pulses, ultrasound, and iontophoresis. All these procedures were able to increase permeability parameters, e.g., lag time, permeability coefficient, skin content of drug, and 24-h receptor concentration, in isolated skin samples from hairless mice or human cadavers. In addition, enhancers such as terpenes, 1-dodecyl hexahydro-2*H*-azepine-2-one, *N*-dodecyl-2-pyrrolidinone, glycyrrhizin (from Chinese herbal medicine), and ethosomes, were tested to increase transdermal delivery of drugs. Ethosomes, phospholipid vesicles of short-chain alcohols, were shown to deliver model drug molecules, e.g., testosterone, to a skin depth of 240 μ , compared with the delivery of testosterone to a depth of 20 μ by liposomes. Ethosomes also have a high entrapment capacity so that more drug can be delivered.

Transdermal delivery of proteins, oligonucleotides, and DNA is severely limited because of their size.⁶ Microfabricated microneedles can be used to deliver these highly impermeable compounds across the skin. Microfabrication techniques including deep reactive etching, micromolding, and electroplating were used to generate arrays of hollow silicon and metal needles. These microneedles were shown to penetrate the stratum corneum of the skin without breaking and without stimulation of nerves in the deeper tissues. The volume of water delivered by the microneedles was similar to that of a 26-gauge needle. In vitro transport experiments using heat-stripped human epidermis mounted in Franz diffusion chambers showed that insertion of hollow silicon microneedles resulted in skin permeabilities to calcein, insulin, and bovine serum albumin on the order of 10^{-1} cm/h. In addition, in vivo experiments showed that insulin (Humulin) delivered by microneedles to hairless rats caused large reductions in blood glucose levels. Finally, human volunteers reported no pain when microneedles were pressed into their skin.

V. TUMOR-TARGETED DRUG DELIVERY SYSTEMS

Cancers are malignant tumors produced by an unchecked and unregulated growth potential. These tumors are able to proliferate locally by invasion of surrounding tissues and systematically by metastasis to distant sites. The appearance of cancer cells could be due either to defects in the mechanisms responsible for regulating cell proliferation or terminal differentiation. The treatment of cancer is a complex and difficult undertaking. Some of the problems are the monitoring of the response of the tumor to the anticancer drug treatment and the delivery of the appropriate drug dosage to the tumor sites.

Solid tumors display a reductive environment because of hypoxia and the overproduction of bioreductive enzymes. To take advantage of the characteristics of the environment provided by the solid tumor, a bioreductive, tumor-targeted drug delivery system was designed. The system would undergo

bioreductive activation as well as neighboring group participation due to conformational restriction to facilitate drug delivery at the solid tumor site. The redox activation of the delivery system was sensitive to the electronic effects of functional groups and the pattern of substitution. Electron-withdrawing and electron-donating constituents resulted in higher and lower reduction potentials of the delivery system, respectively. The constituents of the delivery system significantly modified the rate and extent of anticancer drug delivery. Optimizing the reductive and bioreductive activation of the delivery system can theoretically transfer the most appropriate doses of anticancer drugs to the sites where they are needed.

The tumor-targeted drug delivery system can also be used to minimize the toxicity of anticancer drugs. Acivicin is an antineoplastic agent. Because it is a derivative of large neutral amino acids, e.g., phenylalanine, acivicin is transported across the blood–brain barrier by the large neutral amino acid transporter, resulting in dose-limiting neurotoxicity in patients with solid tumors remote from the brain. Bioreversible derivatization of acivicin to a tumor-targeted drug delivery system rendered the anticancer agent unrecognizable to the large neutral amino acid transporter, thus avoiding accumulation in the brain. In addition, the tumor-targeting drug delivery system directed acivicin to solid tumors in the periphery. On the other hand, antineoplastic agents that resemble large neutral amino acids would facilitate their entry for the treatment of tumor in the brain. For example, *L-meta*-sarcolysin was found to be taken up into the brain 100 times more rapidly than melphalan, a *para*-substituted nitrogen mustard derivative of L-phenylalanine.

Metastasis can be treated by the use of the tumor cells as the drug carrier. Doxorubicin-loaded B16-F10 murine melanoma cells were intravenously administered into C557B1 mice preinoculated with live B16-F10 tumor cells. The drug-loaded tumor cell system was able to prevent metastases formation from a control level of 5.54 in mice injected with saline solution to 4 in doxorubicin-treated mice. The drug-loaded cells were also able to cause remission of metastases after they were formed.

Another direction in the treatment of cancer is to deliver the anticancer drugs, e.g., lomustine, immunotoxins, doxorubicin, and monesin, in liposomes. These lipid vesicles can be prepared, for example, with varying concentrations of dipalmitoyl phosphatidylcholine, cholesterol, distearylphosphatidyl ethanolamine linked to polyethyleneglycol, *N*-[3-(2-pyridyldithio)propionyl] linked to stearylamine, and stearylamine. The drug-loaded liposomes were demonstrated in animal models to increase systemic drug exposure and site specificity and to decrease the cytotoxic effects of the anticancer agents. These drug-loaded liposomes can also be used through direct injection into solid tumor sites.

Dosing of anticancer agent can be limited by its potential systemic toxicity.⁷ Intratumoral injections of paclitaxel–ReGel complex have been demonstrated to inhibit tumor growth with no observable systemic toxicity. The distribution of paclitaxel (PAC) in female athymic nude mice bearing human breast carcinoma xenografts (MDA-231) after an intratumoral injection of a nontoxic, biodegradable thermal gel (ReGel) complexed with ¹⁴C-PAC was followed. Tumor paclitaxel levels decreased slowly over

a 6-week period with a half-life of 20 days. Less than 0.1% of the total radioactivity was distributed to other organs as the drug cleared the tumor environment. Feces (68%) were the major route of elimination with only a small fraction excreted in urine (3%) on day 42. These results supported the observation of a lack of systemic toxicity through direct intratumoral injection of an anticancer agent in a ReGel complex.

Aptamers are oligonucleotides that possess high affinity for protein targets (0.01–10 nM).⁸ Tenascin-C is an overexpressed extracellular matrix protein in carcinomas (breast, lung, prostate, and colon), melanoma, and glioblastoma. An aptamer against tenascin-C, TTA1, prepared by solid-state synthesis with technetium chelator linked to the 5' end of the oligonucleotide, was found to bind with high affinity (5 nM) and specificity to the target protein. Blood clearance of the aptamer was rapid with $t_{1/2} < 2$ min, following intravenous administration of 3.25 mg/kg of ^{99m}Tc-labeled aptamer in athymic mice with human U251 glioblastoma xenografts. At 1 h, tumor uptake was 3.6% injected dose (ID)/g of tumor, whereas a nonbinding control aptamer displayed low tumor uptake, 0.15% ID/g of tumor. TTA1's tumor/blood ratio was 25 at 1 h, 100 at 9.5 h, and 200 at 17 h. Aptamers may be an important entity in the treatment of patients with cancer.

VI. BIODEGRADABLE DRUG DELIVERY SYSTEM

One of the ideal situations in the treatment of disease is the delivery of efficacious medication to the site of action in a controlled and continual manner at the appropriate concentration. Controlled-released, biodegradable nanoparticles that can be loaded with the appropriate drug products have been developed to treat conditions such as cancer, arthritis, and osteoporosis. In view of their low toxicity and their protein-binding properties, the nanoparticles may be useful in the oral administration of peptides, proteins, and oligonucleotides, especially for vaccination.

A. Characteristics of Nanoparticles

The properties of nanoparticles depend on surface morphology, specific surface area, particle size distribution, bulk density, drug incorporation, capacity, release, hydrophobicity, bioadhesiveness, and biodegradability. Nanoparticles (microspheres) loaded with the drug product can be formulated using copolymers, e.g., poly(lactide-co-glycolide) (PLG) or poly(lactide-co-ethylphosphate), by solvent extraction/evaporation technique.

During the preparation of nanoparticles, process variables, such as phase volume, polyvinyl alcohol (PVA) concentration, polymer composition, and stir speed, can affect the particle size distribution and in vitro release profiles of the drug, e.g., progesterone for the treatment or prevention of osteoporosis in postmenopausal women. Decreasing the phase volume from 22–9% increased the rate of progesterone release from the microspheres. Increasing the PVA concentration increased the percentage of smaller-size microspheres as well as the rate of progesterone release from microspheres of the same sieve-size

fraction. Polymer composition and stir speed during preparation had a significant effect on the particle size distribution and the release rate of progesterone from the microspheres. None of these parameters affected the efficiency of encapsulation of progesterone.

The release rate of drug product from the nanoparticles can be engineered through the use of different proportions of reaction reagents. For example, poly(lactide-co-ethylphosphate) was synthesized by melt polycondensation with lactide, ethyl dichlorophosphate, and propylene glycol. Nonaggregated nanoparticles with an encapsulation efficiency of greater than 96% could be successfully prepared by the solvent evaporation method. The release rate of the drug product was faster for microspheres with a 5:1 lactide to propylene glycol ratio, followed by polymer microspheres with 8:1 and 10:1 ratios. Manipulation of the release rate means that the nanoparticles can be used to deliver drug products for various periods of time. In vitro studies established that the efficacy of most drug products depends both on concentration and exposure time.

Biodegradable nanoparticles consisting of negatively charged sulfobutyl-PVA-graft-PLG (SB-PVA) were compared with commercial latex beads, PLG, and grafted DEAE-PVA-PLG nanoparticles on the ability to adhere to Caco-2 monolayers grown on permeable filter inserts. Five times more commercial polystyrene nanoparticles of 50 and 100 nm were shown to attach to the Caco-2 cells than those of 200 and 500 nm. Two times more SB-PVA nanoparticles of 100-nm adhered to the cultured cells than the commercial polystyrene, PLG, and grafted DEAE-PVA-PLG nanoparticles of the same size. Adhesion of the SB-PVA nanoparticles was further increased by the presence of fluorescein isothiocyanate-conjugated bovine serum albumin. Fluorescent imaging showed that the 100-nm nanoparticles could be observed intracellularly mostly in the basal cell compartments and were also found within membrane pores below the cell monolayer. The viability of the Caco-2 cells was not affected up to a nanoparticle concentration of 2.5 mg/mL.

Controlled-release biodegradable PLG polymers loaded with parathyroid hormone were formulated as a freeze-dried form with particle size ranging from 27 to 47 μ . The freeze-dried method did not alter the surface morphology, particle size, and parathyroid hormone content or release rate of the microspheres. The freeze-dried microspheres resuspended very rapidly and uniformly in solution. In vitro release studies indicated that except for a slight early burst ranging from 4–18%, release of parathyroid hormone from the nanoparticles was very slow over the first 14 days. At 15 days, release of parathyroid hormone accelerated rapidly.

B. In Vivo Applications

To study the effect of particle size of drug particles and/or carriers for achieving optimal delivery of drug to solid tumors, surfactant-treated fluoresceinated polystyrene spheres containing paclitaxel were administered systemically to tumor-bearing mice. Delivery of the microspheres to solid tumors depended on particle size. Solid tumors took up a 4- to 5-fold greater number of particles with a mean size of 100 nm than of those with a mean size of 200 nm. As

expected, the efficacy of paclitaxel to elicit a cytotoxic response on the tumor cells depended on the amount of microspheres taken up by the tumors.

Spherical microspheres of PLG with relatively low surface porosity and particle size in the 17μ range were formulated to contain a luteinizing hormone, releasing hormone antagonist, Orntide, for the suppression of testosterone, e.g., in patients with prostatic carcinoma. In vitro release studies showed a sustained release of the peptide for at least 30 days. Elevated blood levels of the peptide were observed for about 28–30 days and testosterone was suppressed for at least 30–35 days in an animal model. No initial increase of the blood level of testosterone was observed and the onset of suppression of testosterone occurred within 6 h.

Monoarticular arthritis was produced in the left knee joints of rabbits by using ovalbumin and Freund's complete adjuvant as antigen and adjuvant. Naproxen sodium nanoparticles that were smooth and spherical in shape with a particle size of approximately $5\text{--}9\mu\text{m}$ were injected into the knee joints. A decrease in the arthritic to normal joints ratios was observed over time. The naproxen sodium nanoparticles were more efficacious than the free drug.

Restenosis can be described as reobstruction of blood vessels after a mechanical reopening procedure and is a major complication following coronary artery angioplasty. Apart from the reperformance of the mechanical procedure, direct delivery of drugs to the site of restenosis with a catheter appears to be a viable option. Nanoparticles and microparticles were formulated using a PLG polymer. Two agents, dexamethasone and U86983 (a 2-aminochromone antiproliferative), were loaded into the nanoparticles and microparticles and shown to reopen blood vessels in rat carotid models. These particles were further coated with didocylmethylammonium bromide to effect optimal drug release at the blood vessel walls. Restenosis was reversed when the particles containing U86983 was delivered to the site in pig coronary angioplasty studies. This process may be used in the treatment of humans.

VII. PROTEIN DRUG DELIVERY SYSTEM

As stated before, hormones, proteins, and small peptides are not suitable for oral administration without complex modifications in the formulation. To illustrate the tremendous efforts spent in the delivery of these entities, insulin has been chosen as a model drug for experimentation.

Insulin is the principal drug used to prevent ketosis and sustain life in the treatment of patients with type I (insulin-dependent) diabetes mellitus. Delivery of proteins such as insulin is a challenge because of the molecular size and the sensitivity of the molecule to the loss of its biological activity through minor alterations in the three-dimensional structure. The normal mode of delivery of insulin to patients at the present time is through intramuscular, subcutaneous, or intravenous injections. These delivery methods are not ideal because of (1) the need for training of the patient or the caretaker in the basic steps of injection, (2) the fear of needles by patients, and (3) the feeling of pain and possible fibrotic formation at the injection site. These inconveniences could lead to noncompliance. A variety of approaches for insulin delivery have been

attempted to improve on the bioavailability of this important protein drug. Advances have been realized in the delivery of insulin through the oral, nasal, rectal, dermatological, and ocular routes.

A. Oral Route

One major roadblock in the delivery of insulin via the oral cavity is the need for the drug to pass through the acidic environment of the stomach and the presence of peptidases in the stomach and the small intestines, resulting in the inactivation of the drug. Various processes have been generated to improve on the oral bioavailability of the protein. Insulin can be encapsulated in time-released dosage forms or micellar formulations, attached to bile acids, modified with amphiphilic polymers, or coadministered with delivery agents.

Time-released dosage forms of insulin were prepared using the compression-coated tablet technique with the core tablets containing insulin and the outer layer composed of polyethylene oxide and polyethylene glycol.⁹ During passage through the upper gastrointestinal tract, the outer layer gelled rapidly and allowed water penetration into the core of the tablet for the dissolution of insulin. At the same time, the outer layer was being gradually eroded until the release of insulin was possible. If the dosage form was engineered correctly, the release of insulin should occur when the formulation reached the small intestines. One time-released dosage form (TR2) was found to release insulin with a lag time of 2 h in an *in vitro* dissolution test. A decrease of plasma glucose level was observed 2 h after oral administration of the insulin dosage form in dogs.

An oral mixed micellar formulation containing 50 units of insulin was administered to normal human subjects, resulting in a serum C-peptide lowering effect similar to that of subcutaneous injection of insulin (10 U) over a 3½-hour period postdose. The onset of action of the oral formulation was faster than that of insulin delivered by the subcutaneous route. The oral insulin formulation and subcutaneous insulin injection produced a similar blood glucose-lowering effect in 10 type I diabetic patients. The oral insulin formulation with 30 and 50 U of insulin provided areas under the curve (AUCs) of 77 and 82 μU/mL, respectively, representing 55 and 66% of the AUC obtained from injected insulin.

Human insulin was acidified and added to appropriate amounts of sodium palmitate solution containing deoxycholate salt. Oral administration of these insulin-containing deoxycholate–palmitic acid dispersions at doses from 10 to 40 U/kg to rats and rabbits resulted in a significant reduction of blood glucose level in 30 min. The glucose-lowering effect lasted for 4 h.

Insulin was modified with amphiphilic polymers comprising polyethylene glycol (PEG_{*n*} with *n* = 1, 2, . . . , 50) and an alkyl, fatty residue, or derivatized sugar, resulting in the yield of mono-, di-, and triconjugates.¹⁰ Conjugates that have C6 to C18 chains and conjugates with a derivatized sugar moiety were highly resistant to degradation by chymotrypsin *in vitro*. Monoconjugates with small PEG units (*n* = 3–7) were demonstrated to have potency in the depression of blood glucose levels comparable to that of nonconjugated insulin when both were delivered subcutaneously in mice. Mono- and diconjugates carrying

short to medium-sized PEG units ($n = 1-12$) in combination with a carbon chain (C1 to C18) or a derivatized sugar molecule administered orally were active in the closed-loop rat model through intestinal absorption. The conjugates in which the alkyl spacer was directly attached to insulin showed high activity in these rats.

A series of derivatized non- α -amino acids as delivery agents for insulin have been developed to overcome the physiochemical and biological barrier in the oral route. Human insulin (78 U/kg) administered orally in combination with delivery agents 3-[4-(2-hydroxybenzoyl)-aminophenyl]propionic acid, 4-[4-(2,3-dimethoxy benzoyl)aminophenyl]butyric acid, or 8-(2-hydroxy-4-methylbenzoyl)aminocaproic acid (at doses of 300 mg/kg each) significantly decreased blood glucose levels by approximately 50% in diabetic Sprague-Dawley rats in 0.5–1 h compared with a 60% decrease induced by subcutaneously administered human insulin in 1-h in the same animals. Oral delivery of insulin or the delivery agents alone did not alter the blood glucose levels in these animals.

Another method of delivery of insulin is to conjugate the protein with transferrin. Oral administration of the insulin–transferrin complex and insulin in streptozotocin-induced diabetic mice lowered the blood glucose levels by 28 and 5%, respectively. The blood glucose level was further decreased to 40% when the mice were pretreated with brefeldin A, a fungal metabolite, before the administration of the insulin–transferrin complex. The potentiation by brefeldin A indicated that insulin absorption could be accomplished through a transferrin receptor-mediated transcytosis in the intestinal wall.

Another delivery system encapsulates the insulin in agarose hydrogel nanoparticles, which are then coated with PLG to form microspheres. This delivery system has a smooth surface and nearly spherical shape with average diameter of 150 μ and an insulin-loading capacity of 90%. In vitro testing showed that these microspheres possessed sustained-release characteristics. Administration of these microspheres orally to diabetic Wistar rats reduced their blood glucose to near-normal levels within 4 h. The reduced blood glucose levels were maintained for 8 h and depended on the dose given.

B. Pulmonary Route

Delivery of medication through the nasal route has been recognized as a viable alternative to traditional oral administration. Formulations containing nanoparticulate heparin complexed to insulin were prepared by mixing aqueous solutions of insulin and low molecular weight heparinic acid (insulin–heparin at 20:80 w/w). The formulation (0.1 mL) was administered to the lungs of anesthetized male New Zealand White rabbits through a catheter. The insulin–heparin complex (1 U/kg dose of insulin) produced a prolonged decrease in the blood glucose levels for 5 h following nasal administration. The blood glucose levels were lowered by 88 and 70% within 2 h and at the end of 5 h, respectively. Comparatively, the hypoglycemic effect of the insulin–heparin complex was three times that of neutral protamine Hagedorn insulin. It was proposed that heparin enhances the absorption of insulin in the lung.

C. Rectal Route

Insulin can be delivered through the rectal route. A liquid insulin formulation was developed to convert into a gel suppository following introduction in the rectum. A mucoadhesive insulin liquid suppository (insulin–poloxamer P407–poloxamer P188–polycarbophil–sodium salicylate: 100 IU/g : 15% : 20% : 0.2% : 10%) was shown to decrease plasma glucose levels in diabetic rats within 0.5 h. Comparatively, it took a longer time for insulin-containing solid suppository to lower the plasma glucose levels of these animals. The optimal gelation temperature, gel strength, and bioadhesive force of this preparation were 32 °C, 22.3 s, and 3800 dynes/cm², respectively. No morphological damage to the rectal tissues was noticed following the insertion of the liquid suppository.

D. Dermatological Route

Compressed helium gas was used in a dermal PowderJect device to deposit insulin in dry powder preparation into the skin for subsequent absorption into the systemic circulation.¹¹ Powdered formulations containing human insulin were prepared by freeze-drying, compression, milling, and then sieving (38–53 μm) using a sodium phosphate mixture as the bulking excipient. One milligram of the insulin formulation was administered via the dermal PowderJect device to shaved skins of anesthetized Sprague–Dawley rats at doses equivalent to 0, 1, 3, and 10 U/kg insulin. Pharmacokinetic analysis showed that the AUC of insulin correlated with the doses. In the first 60 min following administration, the blood glucose levels of these rats were lowered significantly. The action of insulin was observed for longer than 240 min following the 3 and 10 U/kg doses.

Proteins can also be delivered transdermally using a lipid-based biphasic delivery system in therapeutic quantity. Insulin treatment (10–50 mg/g formulation) was administered by a transdermal patch adhered to the abdomen of anesthetized Sprague–Dawley rats made diabetic by a single injection of streptozotocin (55 mg/kg). Blood was sampled from a tail vein every 2–4 h for 48 h. Response to transdermally applied insulin was both pH and concentration dependent. Blood glucose was decreased by 55% in the treated animals with mean response duration of 15 h. Serum insulin level was 162 pg/mL.

E. Ocular Route

Medication can be delivered via the eye in the form of eyedrops or in an ocular device. Sodium or zinc insulin was incorporated into a Gelfoam sponge-based device. An *in vitro* dissolution test indicated that the release of insulin from the device was proportional to the flow rate of the dissolution medium. An *in vivo* dissolution experiment provided support for the hypothesis that there was a direct relationship between the prolonged pharmacological response to insulin and its release from the device. The ocular device with or without the aid of an enhancer was placed in the eye of rabbits as an ocular insert and produced a uniform blood glucose-lowering effect of 60% over 8 h. The blood glucose

level gradually returned to the baseline level if the device was removed from the eye. It was feasible that the slow and continuous rate of tear production and its elimination through the lower cul-de-sac assisted the prolonged release of insulin and its continual pharmacological action. Comparatively, only a blood glucose-lowering spike was observed over 1.5 h following the delivery of the same dose of insulin and an enhancer by an eyedrop.

VIII. DEVICES

A. Needle-Free Injectors

Drugs including flu and hepatitis B vaccines, insulin, growth hormone, female hormones, and some antibiotics are not suitable for oral delivery. An alternative way is to deliver these agents through injection. There are an estimated 550 million injections of vaccines, hormones, adrenaline, erythropoietin, acute migraine treatments, and other therapeutic proteins each year. Historically, these drugs are stored in vials and delivered by syringes or the formulations are stored in prefilled syringes. This form of drug delivery is often perceived as cumbersome and painful, thus generating fear among patients. It is estimated that in the United States alone, 1 million people every year suffer injury or infection from hypodermic needles, requiring treatment from a health care professional.

Needle-free injectors have been developed to resolve the issue of pain and fear and hence to improve compliance. There are two types of needle-free injectors: fluid and powder. Needle-free powder injectors have been utilized for the delivery of vaccines for hepatitis B, apromastil for erectile dysfunction, the anesthetic lidocaine, a granulocyte-macrophage colony-stimulating factors tumor vaccine for malignant melanoma, and DNA-coated particles.

The concept that accelerating a jet of fluid or powder to high speed provides large penetrative powers has been used to develop needle-free injectors. A nozzle with a fine diameter, e.g., 0.5–0.7 mm, is placed in contact with the skin. The diameter of the nozzle is important. The drug will not be propelled through the skin at a fast enough rate with a too-small nozzle diameter, whereas the drug will penetrate the skin more deeply and cause pain with a larger nozzle diameter. A plunger or piston pump is used to push the drug forward, producing a high-pressure jet of fluid or powder. The injectors are powered by springs, batteries, air compressors, or gas cartridges of carbon dioxide or helium.

Intraject is a prefilled, disposable, pen-sized needle-free device for the delivery of liquid medication for patients with diabetes, hepatitis, and migraine headaches. The Intraject system has the liquid drug held in an ampule in a glass capsule. Injection is powered by a metal ram held under pressure by nitrogen gas but restrained by a latch. To use the system, the patient snaps off a glass tip, exposing the orifice at the end of the ampule. Removal of a tear-off safety band enables the actuator to move toward the drug capsule when pressed against the skin. This allows the latch to slide away, resulting in the ram impacting onto a piston at the back of the ampule. The piston is driven forward, pushing the

drug through the orifice with sufficient force to pierce the skin and deposit the drug in the subcutaneous tissue. The injection is over in fewer than 50 ms and produces a sensation similar to flicking of the skin. Volumes between 0.1 and 1 mL could be delivered using Intraject. One study indicated that Intraject delivered a drug with a pharmacokinetic profile very closely resembling that of a standard subcutaneous hypodermic injection. Intraject delivery entailed a slightly faster onset and higher C_{\max} in preclinical animal testing. The faster onset may be due to the wider dispersion of the injectate into the subcutaneous tissue compared with a needle.

The recommended mode of recombinant human growth hormone (rhGH) administration in growth hormone-deficient children and adolescents has been daily subcutaneous injection of growth hormone by means of a syringe. The development of a needle-free injection device for the subcutaneous delivery of rhGH could minimize discomfort. Eighteen growth hormone-deficient children and adolescents (11–20 years of age) participated in a randomized, two-period (4 weeks) crossover study to evaluate the pharmacokinetics and pharmacodynamics of rhGH administered daily either by subcutaneous jet injection or conventional needle injection. Plasma growth hormone (GH), insulin-like growth factor I (IGF-I), insulin-like growth factor binding protein 3 (IGFBP-3), glucose, insulin, hemoglobin A_{1C}, and serum free fatty acids (FFA) levels were analyzed. GH absorption characteristics, expressed as AUC, C_{\max} , and T_{\max} , were similar in both groups of Intraject- and needle-injected patients. IGF-I and IGFBP-3 plasma levels were identical in both groups. Serum FFA concentrations were comparable after GH administration with either injection device. The result of this study showed equal response with regard to absorption and bioavailability of growth hormone administered daily for 4 weeks by either a needle-free or needle injection device in GH-deficient children and adolescents.

For delivery with a needle-free powder injector, the drug is formulated and processed into a fine powder. Several processes, including a compress–grind–sieve method and spray freeze-drying, are utilized to make desirable spherical particles for the injector. A transiently supersonic helium gas jet in a handheld device accelerates the particles. Gas dynamic and particle properties determine the character of delivery into the skin. The penetration depth of the drug is proportional to momentum density. The powder formulation can further influence the drug release profile. Particle size should be in the range of 20–70 μm in diameter. The treated area can be in the range of 3–16 mm in diameter. The amount of powder delivered is 0.5–3 mg.

A needle-free powder injector (PowderJect) was used to intradermally deliver DNA vaccines in mice. Nanogram quantities of DNA encoding the nucleoprotein gene of influenza A virus coated to gold particles elicited a strong and a nucleoprotein-specific cytotoxic T cell response in the animals, indicating effectiveness of immunization with the DNA vaccine.

An immunization strategy consisting of DNA priming followed by boosting with recombinant modified vaccinia virus Ankar induced complete protection against *Plasmodium berghei* sporozolite challenge in mice, as indicated by the appearance of high levels of CD8⁺ T cells. The use of the needle-free powder injector required 10 times less DNA to elicit equally high

CD8⁺ T cell responses and levels of protection compared with intramuscular injection.

PowderJect was used to deliver dry powdered lidocaine hydrochloride to the oral mucosal surfaces of 14 adult, healthy volunteers in an open, non-randomized, placebo-controlled trial. The delivery caused no visible mucosal damage. The median score for pain on blunt needle probing 1 min after delivery was 10 for the PowderJect active sites compared with the score for the placebo sites of 30 and the control sites with no treatment of 58. The results indicated that delivery with the device did not cause tissue damage and was effective in administration of the drug to the site of action.

B. Implants

Implants are devices designed for long-term delivery of drugs such as insulin for the treatment of diabetes. Formulations of proteins can be delivered using programmable and constant rate infusion pumps. The chemical stability of the drug for such a prolonged period has to be validated with HPLC and spectroscopic methods and physical stability can be estimated by a wide variety of methods including accelerated vial vibration testing, circular dichroism, fluorescence spectroscopy, and dynamic laser light scattering. The variables that most affect the performance of insulin formulations in pumps are the buffer choice, buffer strength, and pH. Zinc concentration was particularly important for insulin formulations, whereas chelating agents had little or no effect on the physical stability of the formulations. Most importantly, unidentified variability in different lots of drug substances can lead to large variability in drug physical stability. Physical stability estimation can be correlated via accelerated physical assault of the formulation to long-term stability in the *in vivo* performance of the implantable pumps.

A Hydron retrievable reservoir device filled with nondegradable hydrogels was developed for long-term treatment (1 year or longer) of patients with the goals of improving compliance and reducing cost.¹² The water content of the hydrogels can be adjusted to predetermine the permeability coefficient to yield specific release rates. The implant was formulated from a cross-linked copolymer of hydroxypropyl methacrylate and 2-hydroxyethyl methacrylate. The device was used to treat patients with prostate cancer. This condition can be treated with agonists of gonadotropin-releasing hormone (GnRH), which causes androgen deprivation and results in dramatic regression of lesions and symptomatic response in 80–90% of patients. One year of continuous treatment of 42 patients with stages B1–D2 prostate cancer who had had no prior hormonal therapy with the Hydron implant containing GnRH agonists resulted in complete suppression of luteinizing hormone, suppression of testosterone to or below castration levels, and reduction of prostate-specific antigen to normal levels. Complete therapeutic response was observed in 13 patients after 20 months of treatment.

A subcutaneously implantable protein delivery system made up of a DUROS osmotic pump containing dry (lyophilized or spray-dried) protein formulations in nonaqueous suspending vehicle is being developed for long-term release of proteins at the target site.¹³ The duration of protein release can be

adjusted from 1–12 months by changing the semipermeable membrane in the pump. Spray-dried human growth hormone (hGH) was suspended in several different nonaqueous vehicles to determine the stability of hGH in suspension formulations. Stability studies were performed at 37°C for 3 months. The formulations (10% w/w with suspension vehicle) were tested in 150- μ L DUROS implantable pumps using a 3-month semipermeable membrane. The stability of hGH was dependent on the vehicle chosen for suspension. The best suspension vehicles gave consistently greater than 90% recovery of native hGH after 3 months at 37°C, analyzed by both size exclusion and reverse-phase chromatography. In vitro release rate studies performed in phosphate-buffered saline solutions demonstrated a constant 150 μ g/day delivery over 3 months at 37°C. In vivo studies with hypophysectomized rats (eliminating endogenous growth hormone) showed steady growth and induction of IGF-1 for rats receiving hGH suspension via DUROS pumps, indicating that the proteins released were bioactive.

C. Inhalers

Since the inhaled route delivers the drug directly to its site of action in the lung tissues, only a small quantity is required for an adequate therapeutic response.¹⁴ A low incidence of systemic side effects compared with oral or intravenous administration is to be expected. In addition, the onset of action of inhaled drugs is generally faster than that achieved by oral administration. Factors that can affect the quantity of inhaled particles reaching the lungs and their topographical distribution are modes of inhalation, aerosol characteristics, and subject characteristics. The main types of inhaler devices are metered-dose inhalers (MDIs), drug powder inhalers, and nebulizers (jet and ultrasonic).

Both the pressurized MDI and the drug powder inhaler are inefficient, because only a small fraction of the dose is delivered to the site of action. Most of the drug is deposited in the mouth and is swallowed. Modification to pressurized MDIs may remedy this situation by improving on the coordination of dose generation and inspiration or by the use of spacers. The dry powder inhaler can be improved by the use of special excipients. Ideally, a stationary or slow-moving cloud of a selected particle size distribution should be generated at the source by the device. The rate of cloud generation should be such that a patient can accommodate it during a slow inspiration.

RespiMat is a reusable, soft mist inhaler with a mode of action different from that of other inhalers.¹⁵ The mechanical power from a coiled spring forces a metered volume of drug solution through a nozzle in a unique component, the uniblock. The convergence of two fine jets of liquid generates a slow-moving aerosol of soft mist. The fine particle fraction in the aerosol is approximately 66% for an aqueous drug solution and 81% for an ethanolic solution. This value is about 2.5 times higher than the fine particle fractions for chlorofluorocarbon-driven (CFC) MDIs and the velocity is about five times slower (e.g., 10 m/s for an aqueous solution), with both factors contributing to improved lung deposition. In addition, the dose release duration from

Respimat is considerably longer than that from CFC MDIs at approximately 1.2 s.

In scintigraphic studies using fenoterol and flunisolide, mean drug delivery to the lungs was 31–45% of the dose delivered using Respimat compared with less than 20% using a CFC MDI.¹⁶ Safety profiles did not differ between Respimat and CFC MDI administration. Facial deposition data suggested a low risk of untoward effects even in potential misuse situations for Respimat.

Lung deposition of fenoterol with the use of Respimat, a MDI, and a MDI plus Aerochamber in healthy volunteers was found to be 39, 11 and 10%, respectively.¹⁷ The use of Respimat resulted in uniform deposition of drugs throughout the peripheral, intermediate, and central lung zones. On the other hand, oropharyngeal deposition of fenoterol from Respimat was lower than that from the MDI (37% vs 72%).

Asthma is predominantly an inflammatory disease with associated bronchospasm. Medical treatment is directed at reversing or preventing the bronchospasm, inflammation, and edema, as well as eliminating mucus plugs and correcting hypoxemia. Therapy with bronchodilators in patients with asthma is hampered by the development of tolerance to the drugs and the inability of MDIs and nebulizers to deliver the appropriate dosage of the drugs to the appropriate locations in the lung. Forty-three patients with stable asthma were enrolled in a randomized, controlled, double-blind 4-way crossover study with Respimat or a pressurized MDI delivering a combination of fenoterol hydrobromide and ipratropium. It was found that equivalent bronchodilation in the asthmatic patients was achieved at half the cumulative dose delivered by Respimat compared with that of the MDI.

In 36 patients with chronic obstructive pulmonary disease, the bronchodilator effect of ipratropium bromide was greater with delivery via Respimat (total dose 160 μ g) than via MDI (total dose of 320 μ g). Between 45 min after the first drug inhalation and 45 min after the final dose, a greater bronchodilatory effect was obtained at half the cumulative dose of ipratropium. The safety profile was similar.

IX. SUMMARY

New ways and means have been developed for the delivery of drugs in the treatment of diseases in humans. Some of these advances appear to be ready for clinical trials, whereas others show promise. A lot of research has to be undertaken to advance our knowledge in the delivery of drugs in humans.

REFERENCES

1. 1997 AAPS Annual Meeting Contributed Papers Abstracts. *Pharm Res.* 14(Nov. Suppl.):1–500, 1997.
2. 1998 AAPS Annual Meeting Contributed Papers Abstracts. *AAPS PharmSci* 1(1 Suppl.), 1998.
3. 1999 AAPS Annual Meeting Contributed Papers Abstracts. *AAPS PharmSci* 1(4 Suppl.), 1999.

4. Hussain, A. A., Dakkun, A., and Itoh, S. Nasal absorption of ondansetron: an alternative route of drug delivery for nausea control. *AAPS PharmSci* 1(4 Suppl.), 1999.
5. Jenkins, P. G. The mucosal delivery of vaccines and DNA. *AAPS PharmSci* 1(4 Suppl.), 1999.
6. Kaushik, S., McAllister, D. V., Simtra, S., Allen, M. G., and Prausnitz, M. R. Microfabricated microneedles for transdermal drug delivery. *AAPS PharmSci* 1(4 Suppl.), 1998.
7. Morgan, M. E., Ratji, R. C., McRea, J. C., Low, S. J., and Zentner, G. M. Biodistribution of ^{14}C -paclitaxel after intratumoral administration of ^{14}C -paclitaxel-ReGel complex in athymic nude mice. *AAPS PharmSci* 1(4 Suppl.), 1999.
8. Hicke, B. J., Chang, Y.-F., Gould, T., Stephens, A., Warren, S., and Schmidt, P. G. Tumor targeting by an aptamer. *AAPS PharmSci* 1(4 Suppl.), 1999.
9. Sawada, T., Sako, K., Nakashina, H., Fukui, M., and Ohmura, T. Exploitation of novel time-release dosage forms for oral delivery of peptide drugs. *AAPS PharmSci* 1(1 Suppl.), 1998.
10. Radhakrishnan, B., Rajagopalan, J. S., Anderson, W. L., Sommerville, M., Ackler, S., Davis, C. M., Simpson, M., Ansari, A. M., Harris, T. M., and Ekwuribe, N. Structure-activity relationship of insulin modified with amphiphilic polymers. *AAPS PharmSci* 1(1 Suppl.), 1998.
11. Hickey, P. L., Longridge, D. J., McCrossin, L. E., Bellhouse, B. J., and Ashcroft, S. I. H. Administration of insulin via dermal Powderject—reproducible and dose-dependent delivery to the anesthetized rat. *AAPS PharmSci* 1 (1 Suppl.), 1998.
12. Fowler, J. E., Jr., Gottesman, J. E., Reid, C. F., Andriole, G. L., Jr., and Soloway, M. S. Safety and efficacy of an implantable leuprolide delivery system in patients with advanced prostate cancer. *J. Urol.* 164:730–734, 2000.
13. Matsuura, J. E., Muchnik, A., Berry, S. A., Kalashnikova, L., Fereira, P. A., Dehnad, H., Chester, A., Quigley, P., and Zsebo, K. M. Stability, zero-order pumping and bioactivity of a nonaqueous suspension of human growth hormone using a DUROS implantable pump. *AAPS PharmSci* 1(1 Suppl.), 1998.
14. Ganderton, D. Targeted delivery of inhaled drugs: current challenges and future goals. *J. Aerosol Med.* 12(Suppl. 1):S3–S8, 1999.
15. Zierenberg, B. Optimizing the in vitro performance of RespiMat. *J. Aerosol Med.* 12(Suppl. 1):S19–S24, 1999.
16. Kunkel, G., Magnussen, H., Bergmann, K., Juergens, U. R., de Mey, C., Freund, E., Hinzmann, R., and Beckers, B. RespiMat (a new soft mist inhaler) delivering fenoterol plus ipratropium bromide provides equivalent bronchodilation at half the cumulative dose compared with a conventional metered dose inhaler in asthmatic patients. *Respiration* 67:306–314, 2000.
17. Pavia, D. and Moonen, D. Preliminary data from phase II studies with RespiMat, a propellant-free soft mist inhaler. *J. Aerosol Med.* 12(Suppl. 1):S33–S39, 1999.

9

COMPENDIAL TESTING

CHRISTINE F. RICHARDSON

Quality Assurance, Novartis Pharmaceuticals Corporation, Suffern, New York 10901

- I. INTRODUCTION
- II. A BRIEF HISTORY OF THE UNITED STATES PHARMACOPEIA
 - A. USP–NF
 - B. The Pharmacopeial Forum
- III. COMPENDIAL TESTING FOR FORMULATED PRODUCTS AND ACTIVE INGREDIENTS
 - A. Descriptions of Active Ingredients and Solid Oral Dosage Forms
 - B. Identification of Active Pharmaceutical Ingredients
 - C. Assays
 - D. Impurities
 - E. Additional Tests
- IV. WHICH COMPENDIUM TO USE AND WHEN TO USE IT
- V. VALIDATION
- VI. HARMONIZATION OF TESTING METHODS FOR MULTICOUNTRY SUBMISSION
- VII. CONCLUSIONS
- ACKNOWLEDGMENTS
- REFERENCES

I. INTRODUCTION

Compendial testing comprises all of the analytical testing required to prove the identity, efficacy, and safety of drug products before they are packaged or distributed. At the Suffern site, the manufacturing facility for Novartis Pharmaceuticals Corporation (NPC) in the United States, the quality assurance laboratories are responsible for testing raw materials, active ingredients, and formulated products. A variety of analytical techniques are used, ranging from very simple physical testing to complex chromatographic separations. The degree of testing that a product requires depends on the characteristics of the compound, the number of components in the product, and the dosage form. This chapter is designed to give an overview of compendial testing and the regulations that govern it, insight into the development of new analytical methods, and a historical account of the procedures that are ongoing to bring about the harmonization of compendial testing between different countries. Whenever possible, examples of the testing procedures for specific drug products from NPC are given to illustrate differences in analytical procedures and compendial requirements.

II. A BRIEF HISTORY OF THE UNITED STATES PHARMACOPEIA

The United States Pharmacopeia (USP) was a result of the efforts of Dr. Lyman Spalding of New York City in 1817.¹ According to Dr. Spalding's original proposal, the United States would be divided into four districts and delegates would represent each of the medical associations and schools situated within it. Each district would hold a convention at which time a pharmacopeia would be drafted, and representatives were appointed to attend a General Convention that would be held in Washington, DC. At the General Convention, the four district pharmacopeias would be compiled into a single National Pharmacopeia. Through the authority of the Medical Society of the State of New York, Dr. Spalding's plan went into effect.

The first U.S. Pharmacopeial Convention assembled in Washington, DC, on January 1, 1820, and on December 15, 1820, the first U.S. Pharmacopeia was published. At this first convention, it was decided that a revised USP edition would be published every 10 years. In 1900 the decision was made to issue supplements to the USP in the interim between new editions, and in 1940 the period for new editions was changed from every 10 years to every 5 years.

In the years that followed, the USP developed into an agency that established state-of-the-art standards to ensure the quality of pharmaceutical drug products. The primary objective of the USP is to compile a select list of pharmaceuticals every 5 years, including medicinal substances and preparations that are still covered under patent rights.

A. U.S. Pharmacopeia—National Formulary

The pharmacopeia of today is a quality standard for the pharmaceutical industry and contains monographs, procedures for general tests and assays, and a section on reagents and solutions for drug substances, drug products, nutritional supplements, and excipients.² USP monographs are detailed procedures to carry out laboratory testing specific to particular drug substances and drug products. In addition, products can be labeled as "USP," which indicates compliance with the specifications designated in the pharmacopeia.

The United States Pharmacopeia works closely in conjunction with the Food and Drug Administration (FDA), the pharmaceutical industry, and health professionals in establishing their standards, which are enforceable by the FDA and the governments of more than 35 countries. Failure to comply with USP—National Formulary (NF) standards and test methods can result in products that are adulterated, leading to a variety of negative outcomes including FDA recalls and warning letters.

In addition to providing methods and specifications, the USP also provides reference standards that can be used to carry out the testing in the monographs. USP also holds various events throughout the year on topics of interest for the industry. These events are designed to unite experts who have interests in specific topics. Past topics from USP Open Conference Proceedings include "Children and Medicines" and "Communicating Risk to Patients."

B. The Pharmacopeial Forum

The *Pharmacopeial Forum* provides the arena for proposed and forthcoming revisions to the USP–NF. It is published six times per year by the USP, allowing public review to official pharmaceutical standards before they become effective. In doing this, the *Pharmacopeial Forum* encourages a free exchange of ideas and information among the scientists involved in the development of analytical test methods. It is divided into two main sections: Pharmacopeial Previews and In-process Revision.

Pharmacopeial Previews contains new methods that are being presented to the industry for the first time. USP Monographs, NF Monographs, and General Chapters for chemical tests and assays are included within this section. New monographs may be proposed for new drug substances or new dosage forms. They contain all of the test methods and specifications that, if approved, would be required by the USP. The General Chapters section contains test methods specific to particular drug substances or dosage forms. Following a method's debut in the Pharmacopeial Previews section, comments may be submitted to the Subcommittee regarding the proposed monograph or method. These comments would then appear in the In-process Revision section of the *Pharmacopeial Forum*.

The In-process Revision section contains the actual corrections and changes suggested by the industry readers to improve the proposed monograph or method. Therefore, it contains not only the original wording from the Pharmacopeial Previews, but also the proposed changes, allowing the reader to see the history of the review process. Following receipt of comments on monographs or methods, they are reviewed by the Subcommittee who will in turn propose them for official adoption into the USP. Once the Division of Standards Development (DSD) Executive Committee gives approval, the Board of Trustees approves publication and that monograph or method will be slated for the next Supplement to the USP or USP–NF edition.

Typical quality control (QC) laboratories test raw materials, active ingredients, and finished products with different kinds of testing being required for each. The testing for most raw materials follows compendial methods whereas testing for most finished products does not. For new drug products containing new drug substances, there are no compendial methods. Once marketing approval is granted for a new product by the appropriate regulatory agency, the testing methods used in the development of the product will be incorporated into the USP as the official compendial methods. Other situations exist in which a new product contains a previously approved drug substance that may have already-existing compendial methods. The existing compendial methods may not be appropriate for the new product and new methods may need to be developed.

III. COMPENDIAL TESTING FOR FORMULATED PRODUCTS AND ACTIVE INGREDIENTS

In today's age of globalization in business, most pharmaceutical companies distribute their products to more than one country. When a new product

is being considered for marketing, besides the FDA, the regulatory agency for the United States, applications will also be submitted to the regulatory agencies of other countries. Japan, Britain, and Europe each have their own pharmacopeias, testing methods, and specifications. When new drug applications (NDAs) are submitted, sometimes, as we will see, the regulatory agencies will not agree on the degree of testing, and additional testing could be required for products to be distributed in certain countries. In recent years, there has been an effort to harmonize compendial requirements with significant progress being made in certain areas. This section will review some of the tests common to active ingredients and formulated products. The products discussed were chosen because they have unique and interesting testing procedures and intriguing molecular structures and are marketed in a variety of dosage forms. Particular attention will be given to USP requirements.

There are four analytical tests that are considered universal by the FDA for formulated products: description, identification (ID), assay, and impurities.³ In contrast, descriptions of active ingredients and raw materials just describe the physical appearance of the substance. These tests represent the minimum testing requirements for a batch of drug product to be released by the quality assurance laboratory. Additional tests may be required depending on the characteristics of the particular drug substance and the dosage form. For drug substances that are marketed in more than one dosage form, different methods or variations of existing methods might be needed for each. In most testing laboratories, in-house quality standards (QS) exist for each product and strength. The QS contain the testing methods and specifications for releasing a batch of that product. Additionally, the QS may also contain sample high-pressure liquid chromatography chromatograms, ultraviolet (UV)/visible spectra, and infrared (IR) spectra to aid the analyst in carrying out each test.

Initial training of analysts new to the QC laboratory typically involves reading the General Chapters for tests such as thin-layer chromatography, loss on drying, and water testing. These usually contain more detailed information on the theory associated with the test.

In the following section, some of the tests common to active ingredients and formulated products will be discussed.

A. Descriptions of Active Ingredients and Solid Oral Dosage Forms

A description test is a qualitative physical description of the drug product including the dosage form and any visual characteristics: size, shape, color, and any other identifying markings.³ The description test is critical and if it is incorrect, that particular batch of product is immediately considered defective. Description testing is not included in the USP because the physical description of products is unique to the manufacturer. Generic products containing the same drug substance have their own identifying markings different from those of the branded product.

B. Identification of Active Pharmaceutical Ingredients

Identification testing is designed to confirm the identity or presence of the active ingredient by employing a variety of analytical techniques and methods. For drug formulations, the drug substance may need to be extracted from the dosage form. New techniques such as near-IR spectroscopy may eliminate the need to isolate the active ingredient. Once the pure compound is obtained, a spectroscopic technique such as UV, IR, or melting point will be used to compare the sample identity to that of a standard that has been similarly prepared. The characteristics of the compound will help define which type of spectroscopy will be most useful.

One of the most important goals of identification testing is that it must be specific enough to distinguish between compounds with similar structures including starting materials and degradation products. In some cases, non-specific methods are sometimes used in conjunction to obtain a positive ID. High-performance liquid chromatography (HPLC) is a commonly used analytical technique with the retention time being indicative of the compound. However, HPLC retention time is not usually regarded as specific for identification testing, but can be used in conjunction with other tests such as thin-layer chromatography (TLC), IR spectroscopy, UV/visible spectroscopy, or other physical tests such as melting point. When retention time is used, the standard and sample must elute at similar times.

Many drug substances are used in the form of a salt. The identification of these materials may also include a test for the specific counterion used. Common counterions used in pharmaceuticals are sodium, chloride, and pamoate ions as illustrated later in Figure 5.

I. Active Ingredients and Solid Oral Dosage Forms

Metoprolol tartrate is a synthetic drug substance used for the treatment of hypertension (Fig. 1). The drug substance is a 2:1 salt that contains a racemic mixture of optical isomers of metoprolol and naturally occurring *dextro*-tartaric acid.⁴ Both the active ingredient and the tablet form have different testing requirements.

Metoprolol tartrate tablet testing uses UV and IR spectroscopy for metoprolol ID, TLC for the tartrate ion ID, and HPLC retention time for identification. The IR spectroscopy test is carried out by dissolving approximately 136 mg of finely ground tablets and in 25 mL of water with 4 mL of ammonium hydroxide (1:3). After extraction with chloroform, the organic layer is dried over anhydrous sodium sulfate, evaporated, and placed in a freezer to congeal

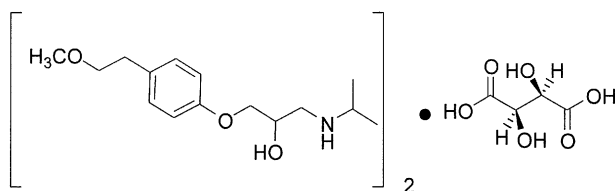

FIGURE I Structure of metoprolol tartrate.

the crystals. Once formed, the crystals are triturated with potassium bromide and used in pellet form to obtain an IR spectrum that is then compared to that of a standard similarly prepared.

The test for the tartrate ion follows a very common procedure for TLC. Sample and standard solutions of equal concentration are spotted on a chromatography plate containing a specific adsorbent. Standard and sample solutions of equal concentrations are prepared, spotted on a chromatography plate, and allowed to develop. Separating the components within the sample solution is based on differences in affinity for the stationary TLC adsorbent versus the moving solvent system. The moving solvent system, or mobile phase is used to develop the plate, moving the samples a particular distance, commonly known as the R_f value. If the substances in the sample and standard solutions are the same, they will have identical R_f values. Most organic compounds are not colored and do not fluoresce within the visible light range, i.e., are not visible to the naked eye and require some form of visualization. In most cases, UV light enables the analyst to see the spots and calculate the R_f value. In contrast, the injectable form of metoprolol tartrate requires only IR identification with a procedure almost identical to that for the tablet form. The only difference is that a specific volume of the injectable solution, which is already dissolved in water, is used in the extraction. This is a good example of a situation where only a slight modification of the analytical procedure was needed for two very different dosage forms. Carbamazepine is an analgesic and anticonvulsant⁵ distributed as tablets, chewable tablets, and an oral suspension (Fig. 2). The active ingredient, tablet, and oral suspension dosage forms have distinctly different identification procedures.⁶

The carbamazepine active ingredient has an identification test unique for testing raw materials, X-ray diffraction.⁷ Each crystalline form of a compound yields its own unique X-ray diffraction pattern, which is considered a form of identification. X-ray diffraction patterns can be obtained from a single crystal or from a sample of powder and then can be used for quantitative and qualitative analysis of the substance.

For the tablet form of carbamazepine, an IR spectrum is obtained with a procedure slightly different from that for metoprolol. To carry out the test, 360 mg of powdered tablets is boiled in 15 mL of acetone, filtered, and evaporated to around 5 mL using a stream of nitrogen. Cooling in an ice bath gives rise to crystals, which after filtration and drying are used in a Nujol mull to obtain an IR spectrum. These procedures illustrate how the raw material and formulated product have different requirements for identification. The formu-

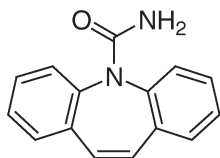

FIGURE 2 Structure of carbamazepine.

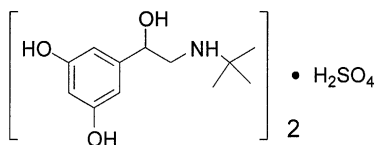

FIGURE 3 Structure of terbutaline sulfate.

lated product requires an extraction and sample purification step, whereas the active ingredient is the pure compound.

Another example of a drug substance with different identification procedures for the dosage form is terbutaline sulfate, which is a synthetic β_2 -adrenoceptor that is used as a bronchodilator for the treatment of asthma (Fig. 3).⁸

The compound is available in inhalation aerosol, injectable, and tablet dosage forms. The inhalation aerosol is the most unique of the three dosage forms. The aerosol consists of a suspension of fine terbutaline sulfate in a pressurized aerosol container equipped with a metered dose valve and oral inhalation actuators.

To extract the sample from the aerosol, 10 filled containers are chilled to -75°C in an acetone-dry ice mixture for 15–20 min. After the tops are removed and the containers are allowed to sit, the contents are poured into a beaker. A portion of this mixture is extracted into chloroform and filtered through a medium-porosity sintered glass funnel. After the residue is washed with chloroform and allowing to air-dry, the crystals are then used to form a KBr pellet and obtain an IR spectrum.

For terbutaline tablets, TLC is used to identify the active ingredient. The tablets are dissolved in dilute ethanol and centrifuged. The insoluble excipients fall to the bottom and the ethanol solution containing the active ingredient is used to spot the TLC plate. The plate is developed using a mixture of cyclohexane, isopropyl alcohol, and formic acid as eluants, and air-dried. In contrast to the tartrate TLC analysis for metaprolol, which used UV light to visualize the spots, the terbutaline TLC analysis uses a specific reagent sprayed onto the plate to assist in visualizing the spots. After the plate is sprayed with a spray reagent, the spots appear colored with the color change indicative of the class of compound and the reagent used. In the case of terbutaline, a phenol derivative, 4-aminoantipyrine-potassium ferricyanide is used. Separate solutions of 4-aminoantipyrine and potassium ferricyanide are prepared and the plate is sprayed with each. Exposing the sprayed plate to 25% ammonium hydroxide results in red-orange to pink spots indicative of phenols. Numerous spray reagents are known and are specific for different classes of compounds.

2. Identification Tests Specific to Active Ingredients

Identification tests for pure drug substances can be different from those for formulated products. Many times, tests for the specific counterion drug substance will be performed on the active ingredient. These tests are very general and oftentimes can follow official compendial methods.

Imiprimine hydrochloride is the original tricyclic antidepressant and is a member of a class of compounds known as dibenzazepines (Fig. 4).⁹

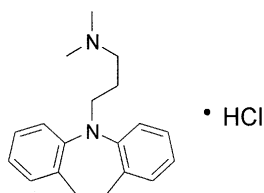

FIGURE 4 Structure of imiprimine hydrochloride.

Imiprimine is a hydrochloride salt available in tablet and injectable dosage forms.

The counterion for imiprimine hydrochloride, chloride, is identified as part of the active ingredient.¹⁰ To carry out the test, the sample powder is dissolved in alcohol, and 2 N nitric acid is added along with 3 drops of a silver nitrate test solution. A white precipitate of silver chloride is formed, which dissolves upon addition of ammonium hydroxide, confirming the presence of the chloride ion. As chloride identification is used for the testing of the drug substance, it is not required for the formulated product.

Imiprimine is also available as a pamoate salt (Fig. 5). The QS ID test uses TLC to identify the pamoate ion. A standard solution of pamoic acid is prepared by dissolving it in a sodium hydroxide solution. The pamoate ion is extracted from the dosage form by dissolving the tablet powder in a sodium hydroxide solution and extracting the active ingredient with chloroform. The pamoate ion remains in the water layer and the chloroform layer is discarded. Both the sample and standard solution are spotted on a TLC plate and eluted with a mixture of acetic acid, ethyl acetate, water, and hydrochloric acid. The plate is developed, dried, and sprayed with a potassium dichromate-detecting reagent to visualize the spots. The simple ion-exchange reaction like that used to identify simple counterions (e.g., chloride or sulfate) cannot be used for the pamoate ion.

The test for ID of the counterion associated with terbutaline sulfate is similar to that for imiprimine HCl. A water solution of terbutaline sulfate is prepared and acidified with hydrochloric acid. Upon addition of a few drops of barium chloride solution, a white precipitate forms, which indicates barium sulfate.

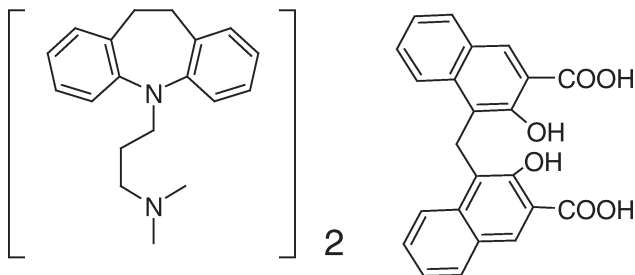

FIGURE 5 Structure of imiprimine pamoate.

The drug substance reserpine is an optically active molecule containing six asymmetric carbons. One of the properties unique to optically active compounds is their ability to rotate plane-polarized light. The degree of rotation depends on the concentration of the sample and the length of the sample path. The specific rotation, denoted $[\alpha]_D$, takes these parameters into consideration and is a measure of a compound's ability to rotate plane-polarized light. All pure optically active compounds have their own specific rotation, which can be used to identify them. The angular rotation of reserpine is determined using a solution of known concentration in chloroform. The angular rotation is then measured using a polarimeter at room temperature and compared with a standard.

Identification testing of pharmaceutical compounds is one of the more interesting types of tests for formulated products in the QC laboratory. Both the physical and chemical properties of the molecule and dosage form challenge the analyst by requiring expertise in wet and instrumental chemistry to correctly identify the material under study.

C. Assays

Another test commonly performed in the QC laboratory is the assay. This test is used to determine the purity of an active substance or the amount of an active ingredient present in a dosage form. The information is used to support the manufacturer's claim on the label. Analytical techniques such as chromatography are typically used. Common methods for testing assays are UV spectroscopy, titration, and HPLC. In older methods, automated UV systems or column chromatography may be employed. For recently developed assay methods, HPLC is the technique usually chosen because its specificity, and older techniques such as automated UV and column chromatography have become obsolete. However, some examples of testing with these techniques do exist in the USP.

Some of the more interesting assay tests are those where more than one drug substance is present in the dosage form. As with identification testing, depending on the dosage form, different procedures may be needed.

One of the most fascinating products containing multiple components is a combination of the natural product reserpine, hydralazine hydrochloride, and hydrochlorothiazide. This drug product is available in tablet form and contains 0.1 mg of reserpine USP, 25 mg of hydralazine hydrochloride, and 15 mg of hydrochlorothiazide (Fig. 6). Reserpine is an indole alkaloid derived from the dried root of *Rauwolfia serpentina* and is well known for its complex molecular architecture,¹¹ the challenges faced during its total synthesis,¹² and its profound effect on the central nervous system as an antihypertensive. Hydralazine is also an antihypertensive and hydrochlorothiazide has diuretic properties. The combination of these three very different molecular structures brings diversity to the analytical testing required.¹³

The typical assay procedure compares an external standard solution of known concentration to that of the sample of the same concentration using a form of spectroscopy or titrimetric technique. The properties of the active ingredient determine which type of spectroscopy would be most suitable. Some

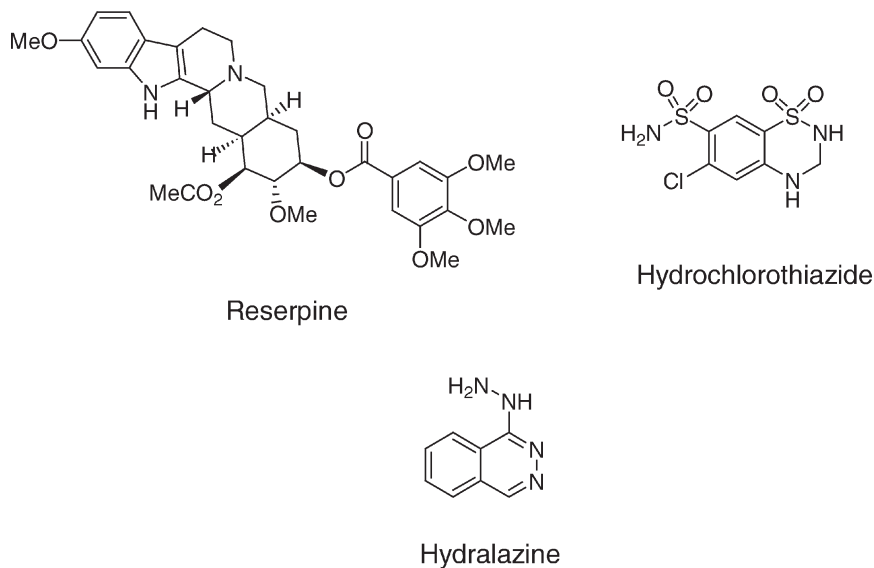

FIGURE 6 Reserpine, hydrochlorothiazide, and hydralazine.

of the most common forms include UV/visible, colorimetric, fluorometric, photometric, or titrimetric.

Due to the unique nature of the three-component product and the different properties of each, three different assay procedures are required.

UV spectroscopy is the most common spectroscopic technique of choice for quantitative analysis. The compound must be able to absorb UV light at a specific wavelength, which will then be used to determine the absorbance of both the standard and sample solutions. In the case of reserpine, all three compounds must be specifically identified and chromatographic separations are required.

Hydrochlorothiazide can be separated from reserpine and hydralazine using ion-exchange column chromatography. A solution of known concentration is then subjected to analysis by UV spectroscopy and compared to a standard solution. The quantity of hydrochlorothiazide present in the sample is then determined.

The assay tests for active ingredients in reserpine and hydralazine also use UV spectroscopy, but the samples are prepared using different procedures. In addition, the wavelengths at which both are measured are different. As a result, there is no convenient way to assay all three compounds at once—resulting in the need for three separate procedures.

Products that are available as capsules have different procedures for assay because of the nature of the dosage form. There are cases where the capsule shells are included in the sample preparation and dissolve in the media, at times they are included but do not dissolve, and in some situations in which the contents are removed and the shells are rinsed and not included. Clofazimine is one of the most active series of the class of phenazine derivatives and was first synthesized by Barry and co-workers in 1957 (Fig. 7).^{14,15} Clofazimine

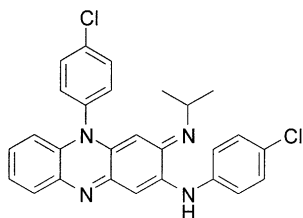

FIGURE 7 Clofazimine.

has been shown to suppress experimental tuberculosis in mice and guinea pigs but is even more effective for the treatment of leprosy.

For the assay test of clofazimine, the capsule shells are not included in the assay preparation.¹⁶ Instead, the capsules are emptied and rinsed to remove all of the sample powder. Results of UV spectroscopy on samples of known concentration are compared to standards and the amount of active is determined.

Another example of assay testing involves diclofenac sodium, which is a synthetic analgesic and an anti-inflammatory drug available as delayed release tablets (Fig. 8).¹⁷

Diclofenac sodium represents an example of a product with a very common HPLC procedure for assay testing. HPLC methods have a different set of requirements than traditional UV methods, which are normally quicker and easier to carry out.¹⁸ A preliminary test called a system suitability test must be run for HPLC methods to assure that the peaks are clearly resolved and that the injections are reproducible, rendering the chromatographic system sufficient for the analysis to be conducted. System suitability tests may require the measurement of different chromatographic parameters, such as resolution, tailing, or theoretical plates. The procedure may contain requirements for these parameters that must be met before the system is used. During the system suitability test, five standard injections are typically made and the relative standard deviation between the injections is calculated to confirm reproducibility of the system. If all the other parameters specified are within the required ranges, the system is then said to have “passed system suitability.” Diclofenac sodium is unique in that the dosage form is designed for “delayed release.”

With the advances in separation sciences, HPLC methods have become more popular and are used almost exclusively for new products being developed.

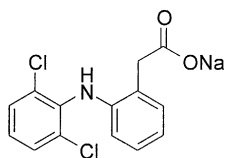

FIGURE 8 Structure of diclofenac sodium.

D. Impurities

Impurity testing is required to determine the purity of the drug product. There are three categories of impurities: organic impurities, inorganic impurities, and residual solvents.¹³ Impurity testing procedures usually follow the same or very similar sample preparations and testing methods as those for HPLC assay, unless the test is for a specific impurity. This is very convenient, and usually the tests can be run concurrently, increasing efficiency.

I. Organic Impurities

Organic impurities can result either from the synthesis of the drug substance or from degradation of the drug substance under storage of the drug product.¹⁹ They can be classified as identified or unidentified. Identified impurities are those whose structure has been determined. If toxicological data is available these impurities could have a higher specification of 0.2%. If no toxicological data is available the specifications will be 0.1%. Unidentified impurities are those whose structure and toxicology are unknown. They have specifications of 0.1%. Organic impurities can include starting materials, by-products, intermediates, degradation products, reagents, ligands, or catalysts. Thus, the identification of impurities is based on the chemical reactions involved in the synthesis, any raw materials used which could contribute impurities, and any possible degradation products. A thorough understanding of the chemical reactions, reaction conditions, and any metabolic degradation pathways is essential for identification of all possible impurities.

Hydrochlorothiazide has a known degradation pathway through which it degrades to the starting material in its synthesis, a disulfonamide (Scheme 1).

The disulfonamide is a known organic impurity usually found in acceptable quantities in the final dosage form. A specific impurity test is conducted to determine the amount of disulfonamide present, ensuring that the quantity is acceptable. For the tablet form, the sample preparation and the chromatographic system is the same as that for the assay tests, allowing them to be run concurrently. An external standard solution of known concentration of disulfonamide is prepared and the peak responses recorded are used to calculate the amount of disulfonamide present in the sample.

Terbutaline sulfate degrades through an oxidative degradation pathway resulting in a number of impurities. One of these, 3,5-dihydroxy- ω -*tert*-butylaminoacetophenone has its own specifications and test procedure.

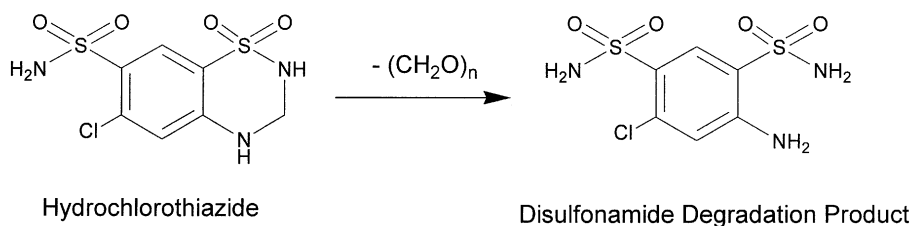

SCHEME I Degradation of hydrochlorothiazide to the disulfonamide starting material.

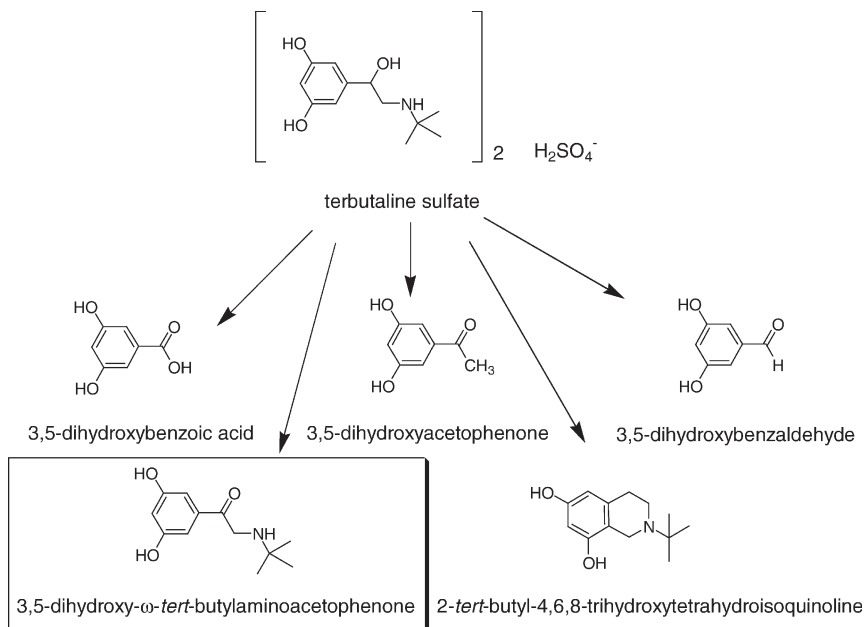

SCHEME 2 Final steps in the synthesis of terbutaline sulfate.

Interestingly, this test is only used for the active ingredient. The tablet form does not require impurities tested to be considered USP.

Imiprimine hydrochloride also has an interesting impurity profile, which takes into consideration both its synthesis and metabolic degradation pathways. The synthesis of imiprimine hydrochloride is shown in Scheme 3.

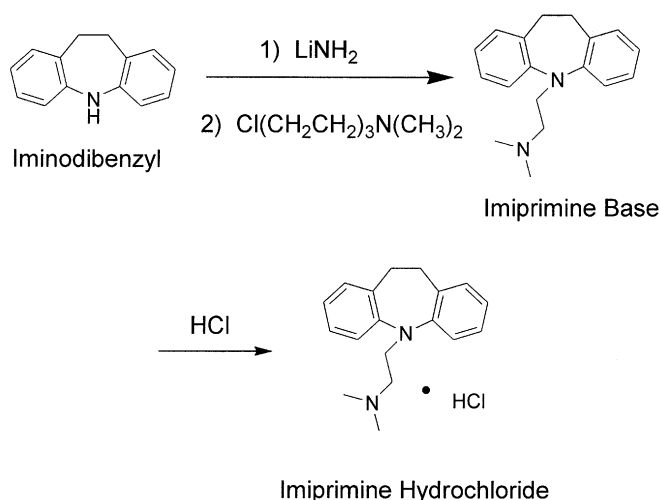

SCHEME 3 Synthesis of imiprimine hydrochloride.

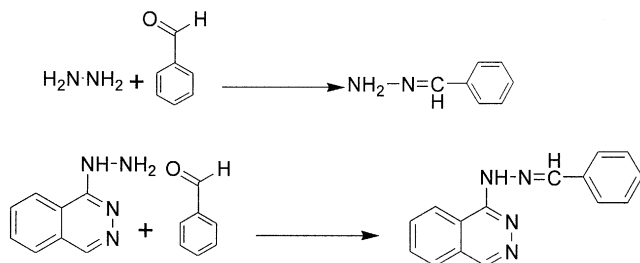

SCHEME 4 Reaction of hydrazine derivatives with benzaldehyde: limit of hydrazine test.

The profile of known impurities for imiprimine hydrochloride includes the starting material iminodibenzyl and two of the known metabolic degradation products: iminostilbene and *N*-(dimethylaminopropyl)iminostilbene. A standard solution consisting of these three compounds is prepared and used to calculate the quantity of each present in a sample.

Chemical reactivity is another way of testing the purity of a drug substance. Hydralazine hydrochloride is part of a class of compounds called hydrazine derivatives. It is well known that hydrazine derivatives react with aldehydes and ketones to give hydrazones.²⁰ The test is conducted by taking a standard reaction of hydrazine with benzaldehyde and comparing it to the same reaction of hydralazine with benzaldehyde as in Scheme 4. By using an HPLC procedure, standard solutions of each derivative are injected, and by comparison of the peak responses, the amount of hydrazine is determined.

2. Inorganic Impurities

Inorganic impurities commonly arise from the manufacturing process and are usually known and identified. Normally, inorganic impurities are determined when the drug substance is tested, not in the final dosage form. They include reagents, ligands, catalysts, heavy metals, and inorganic salts. The common pharmacopeial method for testing for these types of impurities is called residue on ignition. This is used to determine amounts of different metals that may arise as a result of the manufacturing process.

3. Residual Solvents

Residual solvents are solvents that are used during the manufacturing process and may be detected after the product is in its final form. Some of the common solvents are benzene, chloroform, 1,4-dioxane, methylene chloride, and trichloroethylene. Residual solvents in the active ingredient or drug product can come from many different stages in the manufacturing process (active substance granulation, milling, or drug product coating). Because the toxicity of most solvents has been well investigated, it is fairly easy to select appropriate controls for residual solvents that may be found in the final dosage form. The most common technique for measuring residual solvents is gas chromatography (GC) because of the small size and volatile nature of solvent molecules. The USP contains two general procedures for measuring residual solvents using GC. In addition, there is also a third procedure specific for measuring the amount of methylene chloride in coated tablets.

GC has system requirements similar to those of HPLC. The sample is volatilized and an inert gas is used as the mobile phase to carry the sample through the chromatography column. External standard solutions of the solvent in question are prepared and will be compared to sample solutions. The amount of residual solvent can then be calculated using the peak responses.

In summary, impurity testing is necessary to determine the purity of a drug substance or drug product. Determining an impurity profile requires knowledge of the synthesis, metabolic degradation pathways, and all ingredients used in the manufacture of the drug substance.

E. Additional Tests

In addition to the four basic tests for drug substances and drug products, additional tests may be required for releasing drug products. Some of these tests are briefly described in the following section.

Dissolution is a test designed to mimic *in vivo* drug interactions availability. It is carried out in a special bath usually containing six vessels. Into these vessels are lowered either paddles or baskets depending on the product. The paddles/baskets are then spun at a predetermined rate to aid the product in dissolving. After a specific amount of time, aliquots of solution will be taken from each vessel and analyzed by either UV spectroscopy or HPLC, and the concentration will be compared to an external standard solution. Typical dissolution procedures require only one sampling time point. However, for products that are designated as slow-release or timed release, samples may be pulled at more than one time point. For example, methylphenidate is available as a slow-release tablet (Fig. 9).

The dissolution test is conducted over a 7-h time period with aliquots of sample taken every hour. In contrast, diclofenac sodium is available in an extended-release form. The dissolution test is conducted over an 18-h period in which multiple samples are taken, with a change in the dissolution media to simulate a change from the stomach to the gastrointestinal tract. The purpose of dissolution testing is to ensure that the active ingredient is being released from the dosage form at an appropriate time.

Disintegration testing is a procedure that is performed in a water bath. The tablets or capsules are dropped into a basket containing six slots. The basket is placed in a beaker containing the disintegration media. The disintegration bath oscillates up and down and the analyst records the time it takes for the product to completely disintegrate. Disintegration only ensures that the product breaks apart. Carbamazepine tablets require a disintegration test for batch release.

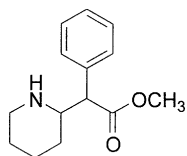

FIGURE 9 Structure of methylphenidate.

Hardness and friability tests are two additional tests usually performed as in-process controls during manufacturing. They will be required for product release when the characteristics of hardness and friability have a critical impact on the quality of the product. Carbamazepine is also available as a chewable tablet and because the hardness is an important characteristic of the tablet, a hardness test is required for batch release.

IV. WHICH COMPENDIUM TO USE AND WHEN TO USE IT

Pharmaceutical companies today are interested in distributing their products to a global market. When filing an NDA, most companies will file with several health authorities (United States, Europe, Japan, and United Kingdom). The NDA consists of all data and findings from all phases of clinical trials. If the product contains a new drug substance, the testing methods will come from the development phase of the drug discovery process. If testing methods are submitted to the USP, they will then become the compendial methods. Different health authorities require different specifications or additional testing for the particular product to be released.

Current FDA guidelines require that methods filed in the NDA be used. Compendial methods and procedures do not have to be used for quality testing; however, official drug products must conform to appropriate compendial standards. Initially, when the FDA approves a new drug product, there are no official compendial methods. Typically, the USP and other pharmacopeias will approach the manufacturer and request the testing methods that will be used so that they can be incorporated into the pharmacopeia. If provided, the testing methods become the official compendial methods. Otherwise, the USP will develop its own methods.

V. VALIDATION

Validation of an analytical procedure is a process required to demonstrate that the procedure is suitable for its intended use (see Chapter 12). Almost all analytical tests require some type of validation. The amount and type of validation will depend on the test procedure. Validation is necessary before an analytical test can become a test procedure in the QC laboratory.

The FDA has identified seven validation characteristics: accuracy, precision, specificity, detection limit, quantitation limit, linearity, and range. Depending on the test being validated, combinations of these characteristics need to be examined.

Accuracy describes the closeness of agreement between the true value and the determined value.

Precision expresses the closeness of agreement between a series of measurements obtained from different samples from the same homogeneous sample. Three different levels of precision exist: repeatability, intermediate precision, and reproducibility. It is usually expressed as the variance, standard deviation, or coefficient of variation of a series of measurements.

Specificity refers to the ability of the test to separate the analyte of interest from other components in the test solution, thereby determining unequivocally its identity. When the test is designed to test for impurities, the compound and each known impurity must be separated from each other. For assays, the test must allow for an exact result of the compound of interest to be separated; however, impurities do not need to be resolved from each other.

The detection limit is the lowest amount of substance that can be detected but not necessarily quantified as an exact value.

The quantitation limit is the lowest amount of analyte that can be quantitatively determined with suitable precision and accuracy. This validation characteristic is used mainly for the determination of impurities and degradation products.

The linearity of an analytical procedure is its ability to obtain results that are directly proportional to the concentration of the sample.

The range is the interval where it has been demonstrated that the analytical procedure has suitable levels of precision, accuracy, and linearity.

Robustness is a measure of the tests' reliability and ability to remain unaffected by small changes in the parameters of the test method.

The FDA, USP, and International Conference on Harmonisation provide guidelines as to which combinations of these validation characteristics are appropriate for each procedure being validated. At Novartis, Table 1 is used to determine the degree of validation required for a given analytical procedure. Using Figure 10, the test is placed into one of five groups, which are identified in Table 1.

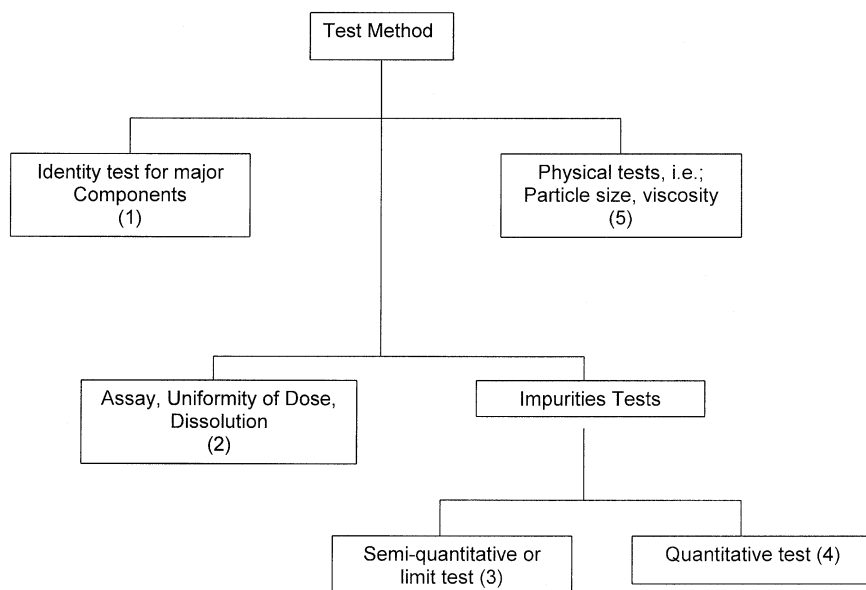

FIGURE 10 Assignment of validation parameters.

TABLE I Assignment of Validation Parameters

Validation parameters	Types of tests				
	(1)	(2)	(3)	(4)	(5)
Accuracy	No	Yes	$\frac{1}{m}^a$	Yes	No
Precision (repeatability)	No	Yes	$\frac{1}{m}^a$	Yes	Yes
Precision (intermediate precision)	No	Yes	No	Yes	$\frac{1}{m}^a$
Precision (reproducibility) ^b	No	$\frac{1}{m}^c$	No	$\frac{1}{m}^c$	No
Linearity	No	Yes	No	Yes	No
Range	No	Yes	$\frac{1}{m}^a$	Yes	No
Specificity ^d	Yes	Yes	Yes	Yes	No
Limit of detection	No	No	Yes	Yes	No
Limit of quantitation	No	No	No	Yes	$\frac{1}{m}^a$
Stability of the solutions	No	Yes	$\frac{1}{m}^a$	Yes	$\frac{1}{m}^a$
Robustness	$\frac{1}{m}^a$	Yes	$\frac{1}{m}^a$	Yes	$\frac{1}{m}^a$

^aMay be required, depending on the nature of the test.

^bIn exceptional cases.

^cIf reproducibility testing has been performed, intermediate precision is not needed.

^dOther supporting analytical procedures may compensate for lack of specificity of one analytical procedure.

Depending on the group, combinations of validation parameters from Table 1 are used to validate a particular test. The methods development group is responsible for performing all the validation testing according to the above specifications.

As new technologies arise, testing methods may become obsolete and will be replaced by newer methods. These new procedures also require validation. Situations also exist for which revalidation of current methods is needed. Circumstances such as changes in the synthesis of the drug substance, composition of the finished product, or changes in the analytical procedure itself are all reasons for revalidation. The degree of revalidation depends on the extent of the changes taking place.

VI. HARMONIZATION OF TESTING METHODS FOR MULTICOUNTRY SUBMISSION

Over the last few years, significant progress has been made to bring together the regulatory authorities of Europe, Japan, and the United States. The main goal is to harmonize the testing, validation, and validation requirements associated with pharmaceutical materials (see Chapter 11). Consequently, the International Conference on Harmonisation of Technical Requirements for Registration of Pharmaceuticals for Human Use (ICH) was established.

The ICH is a unique project that brings together the aforementioned regulatory agencies as well as experts from the pharmaceutical industry to discuss scientific and technical aspects of product registration. Its purpose is

TABLE 2 Comparison of Compendial Requirements

Compendia	IR	Melting point	Fluorescence	Nitric acid	Sulfuric acid	UV
United States	✓					
British		✓	✓	✓		
Japanese		✓	✓	✓	✓	✓
European	✓	✓				

to make recommendations on ways to achieve greater harmonization in the interpretation and application of technical guidelines and requirements for product registration. Reduction of duplicate testing carried out during the research, development, and testing of new medicines are necessary to expedite the availability of new medicines. Increased harmonization provides a more economical use of human, animal, and material resources and eliminates unnecessary delays in the global development and availability of new medicines while maintaining quality, safety, efficacy, and regulatory obligations to protect public health. Each region has two seats on the ICH steering committee that oversees the harmonization activities.

Before the ICH, each country had its own testing requirements, with some health authorities requiring more testing and clinical trials than others. From a quality control standpoint, this would mean that the same product could require more testing depending upon where it was going to be distributed.

A good example to illustrate this problem is carbamazepine. If we just consider the identification testing, depending on which pharmacopeia governs, up to four identification tests may be required. All together, there are six different identification tests among the pharmacopeias. An outline of the tests is presented in Table 2.

Each pharmacopeia has at least one identification test, with Japan having the most at five. The goal of the ICH is to eliminate these differences and harmonize testing so that there would be one set of agreed-upon tests, with the optimal and most efficient tests included.

VII. CONCLUSIONS

The quality assurance function is critical to assure that only effective and safe products are released to the marketplace. The QC analytical laboratory is the final stage in a long line of processes through which many individuals from diverse departments take part to ensure the safety, efficacy, and quality of drug products. Producing quality products requires not only a good testing laboratory, but an organization that is empowered to identify problems and develop innovative solutions. Analytical testing is one of the more interesting ways for scientists to take part in the quality process by providing actual data on the identity, content, and purity of drug products. As we have seen, a variety of analytical techniques are used, ranging from very simple size testing to

complex chromatographic separations. Since the formation of the ICH, new methods are being developed that keep worldwide harmonization at the forefront. Through harmonization, new products can be brought to international markets faster, improving the health and well-being of humankind.

ACKNOWLEDGMENTS

The author would like to thank Olga Sokolova and Austin Kirschner of New York University, Phil Baran of the Scripps Research Institute, and Dr. Stefanie Nair, Sheryl LeRoy, Timothy Reilly, and Dorothy Watson of the Novartis Pharmaceuticals Corporation for their help in preparing the manuscript.

REFERENCES

1. For a complete history of The United States Pharmacopeia, see *USP 23*.
2. For more information on the USP, see www.usp.org.
3. *Fed. Regist.* 62:62893, 1997.
4. Luch, J. Metoprolol tartrate. In *Analytical Profiles of Drug Substances* (K. Florey, Ed.), Vol. 12, pp. 325–356. Academic Press, New York, 1985.
5. Budavari, S., Ed. *The Merck Index*, 12th ed., p. 290. Merck, Rahway, NJ, 1996.
6. *USP 24*, pp. 299–301. U.S. Pharmacopeial Convention, Rockville, MD, 1999.
7. *USP 24*, pp. 299–300; *Monograph 941*, pp. 2005–2007. U.S. Pharmacopeial Convention, Rockville, MD, 1999.
8. a) Ahuja, S. and Ashman, J. Terbutaline sulfate. In *Analytical Profiles of Drug Substances* (J. J. Kettenes-Van Den Bosch, Ed.), Vol. 19, pp. 601–625. Academic Press, New York, 1985; b) Budavari, S., Ed. *The Merck Index*, 12th ed., p. 1565. Merck, Rahway, NJ, 1996.
9. a) Kender, D. J. and Schiesswohl, R. E. Imiprimine hydrochloride. In *Analytical Profiles of Drug Substances*, Vol. 14, pp. 37–75. Academic Press, New York, 1985; b) Budavari, S., Ed. *The Merck Index*, 12th ed., p. 845. Merck, Rahway, NJ, 1996.
10. *USP 24*, pp. 865–867. U.S. Pharmacopeial Convention, Rockville, MD, 1999.
11. Nicolaou, K. C. and Sorenson, E. J. *Classics in Total Synthesis*, pp. 55–64. VCH, New York, 1996.
12. a) Woodward, R. B., Bader, F. E., Bickel, H., Frey, A. J., and Kierstead, R. W. *J. Am. Chem. Soc.* 78:2023, 2657, 1956; b) Woodward, R. B., Bader, F. E., Bickel, H., Frey, A. J., and Kierstead, R. W. *Tetrahedron* 2:1, 1958.
13. *USP 24*, pp. 1474–1476. U.S. Pharmacopeial Convention, Rockville, MD, 1999.
14. Kapoor, V. A. Clofazimine. In *Analytical Profiles of Drug Substances*, Vol. 18, pp. 91–120. Academic Press, New York, 1985.
15. Barry, V. C., Belton, J. G., Conalty, M. L., Denney D. M., Edward, D. W., O'Sullivan, J. F., Twomey, D., and Winder, F. *Nature* 179:1013, 1957.
16. *USP 24*, pp. 441–442. U.S. Pharmacopeial Convention, Rockville, MD, 1999.
17. Adeyeye, C. M. and Li, P. K. Diclofenac sodium. In *Analytical Profiles of Drug Substances*, Vol. 19, pp. 123–144. Academic Press, New York, 1985.
18. For a complete description of HPLC requirements see *USP 24, Monograph 621*, pp. 1920–1926. U.S. Pharmacopeial Convention, Rockville, MD, 1999.
19. *Guideline for Industry Impurities in New Drug Substances*. Food and Drug Administration, Washington, DC, 1996.
20. March, J. In *Advanced Organic Chemistry*, pp. 904–905. Wiley, New York, 1992.

10

METHOD DEVELOPMENT

HENRIK T. RASMUSSEN

Analytical Chemistry Research and Development, The R. W. Johnson Pharmaceutical Research Institute, Raritan, New Jersey 08869

- I. INTRODUCTION
- II. OVERVIEW OF SEPARATION METHODS
- III. HIGH-PERFORMANCE LIQUID CHROMATOGRAPHY
 - A. Applicability to Pharmaceutical Applications
 - B. Phase-Appropriate High-Performance Liquid Chromatography Methods
 - C. Early-Phase Methods
 - D. High-Performance Liquid Chromatography/Mass Spectrometry and High-Performance Liquid Chromatography/Nuclear Magnetic Resonance
 - E. Late-Phase Methods
 - F. Chiral Separations
- IV. THIN-LAYER CHROMATOGRAPHY
- V. GAS CHROMATOGRAPHY
- VI. SUPERCRITICAL-FLUID CHROMATOGRAPHY
- VII. CAPILLARY ELECTROPHORESIS
- VIII. CONCLUSIONS
- IX. SUMMARY
- REFERENCES

I. INTRODUCTION

Numerous methods are required to document the identity, strength, quality, purity, and potency of drug substances and drug products. Specifications¹ may include description; identification; (composite) assay; tests for organic synthetic process impurities, inorganic impurities, degradation products, residual solvents, and container extractables; tests of various physicochemical properties, chiral purity, water content, content uniformity, and antioxidant and antimicrobial preservative content; microbial tests; dissolution/disintegration tests; hardness/friability tests; and tests for particle size and polymorphic form. Certain of these tests may be precluded, or additional tests added, as dictated by the chemistry of the active pharmaceutical ingredient (API) or the dosage form.

Due to the variability in specific tests required to fully characterize a pharmaceutical, it is difficult to provide a comprehensive discussion to address all aspects of pharmaceutical development. However, the requisite tests can broadly be subdivided into the following three main categories:

1. Tests concerned with solid-state characterization
2. Compendial tests cited in regulatory pharmacopeia

3. Quantitative tests to characterize API and drug product composition

Characterization in the solid state is addressed in Chapter 3. Compendial methods are described in the U.S.² and international pharmacopeias (see Chapter 9). Compendial methods should be implemented as written except where scientifically justified changes are necessary. Although considerable efforts are ongoing to standardize compendial methods, differences currently exist between the United States Pharmacopeia (USP) and other pharmacopeias. In these instances, testing should be done in accordance with the procedures described in the pharmacopeia governing the country or region for which the product is intended.¹ Additional details regarding compendial methodologies have been published elsewhere³ and further discussion is beyond the scope of this chapter. Instead, the focus will be to elaborate on method development considerations for quantitative tests to characterize drug substance and drug product composition for eventual filing and transfer to quality units.

II. OVERVIEW OF SEPARATION METHODS

It is notable that most quantitative tests are based on measuring specified components in the presence of a sample matrix and/or related substances and, as a result, isolation or separation of the target analytes is required preceding quantitative analysis. These tests include (composite) assay; tests for organic synthetic process impurities, degradation products, residual solvents, and container extractables; and tests of chiral purity and antioxidant and antimicrobial preservative content. Separation methods may also be required for content uniformity or to monitor dissolution profiles. As a general rule, separation is required for content uniformity or dissolution studies when the signal due to the matrix is greater than 1.5% of the signal stemming from the analyte. In cases where matrix interference is not observed, quantitative measurements may be made using spectroscopic or titration methods directly.

Whereas individual components to be quantitated may be isolated to meet the 1.5% criteria outlined and subsequently quantitated, the more common approach is the use of separation procedures, coupled to suitable detection, to separate and monitor the individual analytes of interest. This is a particularly powerful approach because several of the requisite quantitative measurements can be made from a single analysis of the sample. Using optimized separation procedures, it is possible to monitor the API (for assay), organic synthetic process impurities, and degradation products during a single determination. Similarly, multiple residual solvents may be quantitated in a single analysis.

Chemical separations are achieved using chromatographic and, to a much lesser extent, electrophoretic methods. In chromatographic methods, separation is based on variation in the distribution of different compounds between two dissimilar phases—a stationary phase and a mobile phase. Further differentiation can be made between chromatographic procedures in which the individual components elute from the stationary phase and are monitored on line (column chromatography) and procedures in which the components are measured *in situ* on the chromatographic stationary phase [e.g., thin-layer

chromatography (TLC)]. Electrophoretic procedures are based on separation according to differences in the mobilities of analytes in a conductive liquid medium subjected to an electric field. Solutes are separated based on differences in their hydrodynamic size-to-charge ratios. Separation may also be achieved by adding reagents to the conductive media to provide secondary interactions.

Although TLC maintains some applicability, by far the most common separation methods used in the modern pharmaceutical analysis laboratory are column chromatographic methods. These are named based on the mobile phase. Accordingly, chromatographic methods utilizing a liquid as the mobile phase are termed liquid chromatography (LC), methods using gases as the mobile phase are termed gas chromatography (GC), and methods using supercritical fluids as the mobile phase are termed supercritical-fluid chromatography (SFC). Modern liquid chromatography performed in a highly automated format is termed high-performance liquid chromatography (HPLC). Separations may be performed either using a column packed with stationary phase or using a capillary column where the stationary phase is coated on the capillary wall. These techniques are differentiated as packed-column chromatography and capillary chromatography. In practice, HPLC in the capillary format has shown limited utility due to the slower diffusion of solutes in liquids versus gases and supercritical fluids. Therefore, although the capillary format is frequently preferred for GC, the use of (nonpacked) capillary HPLC has been largely limited to academic research.

The primary goal of chromatographic separations is to separate the components (of interest) in the sample. The condition of separation is achieved when the resolution (R_s) between individual components is greater than a numerical value of 2.0. Resolution can be measured from a chromatogram as detailed in the USP.² However, the measurement of resolution does not direct the approach to achieving resolution.

All column chromatographic separations operate on the same principle: the distribution of solute between two dissimilar phases—a mobile phase and a stationary phase. In each procedure, sample is introduced into one end of the column and the mobile phase transports the sample components toward the other end of the column. In the absence of interaction with the stationary phase, all components would exit the other end of the column after a time, t_0 , based on the column volume and mobile-phase flow rate and could be detected at the other end of the column using an on-line detector. If an interaction with the stationary phase occurs, the time taken for a solute to elute from the column would be increased by the time that the solute spends in association with the stationary phase (t'_R). The ratio of t'_R/t_0 is directly proportional to the distribution coefficient between the stationary phase and the mobile phase and is referred to as the capacity factor (or retention factor) k' . The ratio of the k' s of two solutes to be separated, k'_2/k'_1 , where the subscripts denote the second and first eluting components, respectively, is termed α (the selectivity). It is seen from this discussion that a primary goal in chromatography is to maximize α or, expressed in simplest terms, to establish conditions whereby the difference in the distribution coefficients of the compounds to be separated is maximized.

In addition to optimizing the thermodynamic parameters k' and α , it is also desirable to minimize the dispersion (band broadening) of each solute as it migrates through the column and to ensure that no deleterious secondary interactions are obtained during the migration process. Deleterious secondary interactions are observed as "tailing" peaks and are typically controlled in HPLC and SFC by the addition of chemical additives to the chromatographic mobile phase. The dispersion phenomenon is referred to as separation efficiency (N) and is a measure of the variance in peak width generated as a function of time as the solute migrates through the column. Separation efficiency is also referred to as the number of theoretical plates. For packed-column chromatography, N is increased as column length is increased or particle size is decreased. Under practical operating conditions, N decreases increasing mobile-phase flow rate. However (especially for liquid chromatography), there are limitations on the absolute length, particle diameter, and flow rate that can be used for a given separation because of the pressure generated by the flow of mobile phase through the system. The time taken for a separation to be completed is also of paramount concern. Further discussion of the influence of particle size, column length, and flow rate on separation efficiency and time have appeared extensively elsewhere (e.g., references 4–6) and a comprehensive discussion will not be repeated herein.

Resolution, previously described as the degree of separation between components, can be expressed in terms of k' , α , and N as

$$R_s = \frac{N^{1/2}}{4} \frac{k'}{k'+1} \frac{\alpha-1}{\alpha} \quad (1)$$

From this master resolution equation, it can be observed that suitable chromatographic procedures can be developed by adjustment of k' , α , and N to obtain a resolution of 2.0.

The preceding discussion presumes that the separation conditions with respect to mobile-phase composition, temperature, and pressure are maintained constant throughout the chromatographic separation. In instances where the differences in the distribution coefficients of components to be separated are so large that the components cannot be eluted under the same conditions in a reasonable amount of time, it is possible to vary mobile-phase composition, temperature, or pressure during the course of the run. The parameter to be changed over time depends largely on which parameter most predominantly controls the separation. In HPLC, the distribution of solute between the mobile phase and the stationary phase is governed primarily by the polarity of the mobile phase. It is, therefore, possible to change the composition of the mobile phase over time to provide reasonable distribution coefficients for each component in the sample. This is termed gradient elution. In GC, the primary control parameter is temperature, and it is possible to use temperature programming to effect separations in a reasonable amount of time.

Within the broad scope of developing separation methods for the numerous tests described, a choice must be made as to which separation method is most suitable for each task. This chapter will endeavor to describe not only

the current usage areas of each separation method, but also to comment on the potential applicability of each technique.

III. HIGH-PERFORMANCE LIQUID CHROMATOGRAPHY

A. Applicability to Pharmaceutical Applications

Review of the International Conference on Harmonization (ICH) guidelines for impurities in new drug substances and new drug products^{7, 8} and accompanying guidelines for method validation^{9, 10} quickly underscore the usefulness of HPLC for pharmaceutical analyses. Indeed, it is safe to say that the guidelines were written primarily based on the capabilities of HPLC. An additional testament to the broad acceptability of HPLC is provided in a recent survey in *Pharmaceutical and Cosmetic Quality*.¹¹ HPLC currently accounts for 35% of all instrument usage across the pharmaceutical and cosmetic industries and remains the fastest growing technique in both industries.

HPLC provides reliable quantitative precision and accuracy, along with a linear dynamic range (LDR) sufficient to allow for the determination of the API and related substances in the same run using a variety of detectors, and can be performed on fully automated instrumentation. HPLC provides excellent reproducibility and is applicable to a wide array of compound types by judicious choice of HPLC column chemistry. Major modes of HPLC include reversed phase and normal phase for the analysis of small (<2000 Da) organic molecules, ion chromatography for the analysis of ions, size exclusion chromatography for the separation of polymers, and chiral HPLC for the determination of enantiomeric purity. Numerous chemically different columns are available within each broad classification, to further aid method development.

In normal-phase HPLC, solute retention is based on the distribution of solute between a polar stationary phase and a nonpolar mobile phase (typically a mixture of hexane and a more polar solvent such as isopropanol). Elution may be promoted by increasing the amount of polar solvent in the mobile phase. In reversed-phase HPLC, retention is based on distribution between a nonpolar stationary phase and a polar mobile phase (typically a mixture of water and acetonitrile or methanol), and elution is promoted by addition of the less polar solvent to the mobile phase. With the exception of extremely polar or ionized compounds, which are not amenable to normal-phase HPLC, and extremely nonpolar compounds such as certain steroids and natural products, which are not amenable to reversed-phase HPLC, both modes of HPLC are potentially applicable to APIs and related substances. However, about 75% of current HPLC analyses are performed using the reversed-phase.¹² This is due not only to safety considerations using nonpolar solvents but also to the differences in sample preparation procedures required for normal-phase versus reversed-phase HPLC.

A convenient method for sample preparation of, for example, solid dosage forms is dispersion in water or aqueous media modified with acetonitrile or methanol. In reversed-phase HPLC, the filtrate from this preparation may be injected directly onto the column. Dissolved excipients from the dosage

form are generally much more polar than the components of interest, are not retained by the stationary phase, and, consequently, do not interfere with the analysis. Using solvents more compatible with normal-phase HPLC frequently results in extraction problems. Thus, the use of normal-phase HPLC is applicable to the analysis of drug substance, but drug product requires additional preparation considerations prior to chromatography.

For the separation of chiral molecules into their respective enantiomers, several approaches are possible by HPLC. These include precolumn derivatization to form diastereomers, followed by the use of normal-phase or reversed-phase HPLC, or addition of the derivatization reagent to the chromatographic mobile phase to form dynamic diastereomers during the separation process. Alternatively, specialty columns prepared with cyclodextrins or specific chiral moieties as stationary phases may be used.

In summary, HPLC, particularly reversed-phase HPLC, is currently the most suitable method for meeting most of the criteria for quantitative analysis within the pharmaceutical industry. However, some limitations still exist. It is frequently difficult to select columns from different manufacturers that provide the same performance, and great care should, therefore, be taken in specifying column type for a method to be run interlaboratory. Additional differences exist between instruments from different vendors, and an understanding of these differences is frequently required to successfully transfer methods. For example, differences in the solvent mixing chamber to column head volume in different HPLC pumps and the use of low- versus high-pressure mixing lead to differences in gradient profiles. Differences in detection cell volume and wavelength bandwidth can provide different solute response factors system to system and can generate changes in the linear dynamic range and sensitivity of a method.

Method transfer issues aside, HPLC offers less separation efficiency than observed in other separation techniques such as capillary electrophoresis (CE), GC, and SFC. In fact, it is typically difficult to separate more than 15–20 compounds in a single HPLC run,^{13, 14} necessitating the use of two or more runs for complex samples. As a result, other techniques continue to receive considerable interest. It is, however, safe to say that there are no emerging techniques that will significantly reduce the utilization of HPLC in the short term.

B. Phase-Appropriate High-Performance Liquid Chromatography Methods

It is unrealistic to envision that a single method can be developed for the determination of the API and related substances in both drug substance and drug product and, at the same time, be optimized to support all phases of pharmaceutical development. Instead, the development of a test method should be conducted in the context of a critical examination of what the method will be used to measure and the method validated to demonstrate that these criteria have been met. For early-phase methods, regulatory guidelines are unspecific, whereas, for late-phase methods, regulatory expectations provide a comprehensive set of performance goals that a method should achieve.

Accordingly, the method development guidelines provided here for early-phase methods are flexible and are intended as guidance only. For late-phase methods, there is considerably less flexibility in approach. A comprehensive discussion of method validation is presented in Chapter 12. Validation issues will be addressed here only in the context of developing methods that satisfy the requisite validation requirements.

In the early phases of drug development, the key requirement of chromatographic methods is to separate the new chemical entity (NCE) from all drug substance process impurities and drug substance and drug product degradation products. It is highly desirable to develop two or more orthogonal methods to be used in conjunction to ensure, to the degree possible, that all related substances are detected and identified. Orthogonality may be achieved by using methodologies providing different mechanisms of separation. For example, reversed-phase HPLC, based on partitioning, may be used in combination with CE, where separation is on the basis of solute charge-to-mass ratios. Alternatively, two separate HPLC methods may be developed in which selectivity differences are achieved by using different stationary-phase/mobile-phase combinations. To facilitate identification of related substances, compatibility with on-line mass spectrometry (MS), Ultraviolet (UV) photodiode array, and increasingly (on-line) nuclear magnetic resonance (NMR) detection are critical considerations in developing the chromatographic methods.

Early-phase methods, as outlined in the next section, are suitable for evaluating impurity profiles of synthetic batches, identifying degradation products from forced-degradation and preliminary stability studies, and providing feedback to formulation studies. The methodologies are optimized for the detection and identification of related substances and should ideally result in the understanding of drug chemistry to allow for specifications to be set for process impurities and degradation products.

In the later phases of drug development, after synthetic routes and formulations have been finalized and forced-degradation and preliminary stability studies have been completed, the goal of the methods shifts to high-throughput monitoring of the API and related substances for release and stability testing. Under this requirement, the goal becomes to develop single stability-indicating methods for drug substance and drug product (the methods may or may not be similar) that meet the following criteria.

Drug Substance. Methods should separate the API and the synthetic process impurities and drug substance degradation products observed at significant levels (see Chapter 4) using the early-phase methods.

Drug Product. Methods should separate the API, drug product degradation products, excipients, and excipient degradation products observed at significant levels using the early-phase methods. Drug product methods are not required to monitor synthetic process impurities, unless these are also drug product degradation products.⁸

Due to the intended use of late-phase methods, the methods should be optimized to be as rapid and simple as possible while meeting the specified requirements. Considerations in method development should include the ability to fully automate sample preparation and to ensure that the methods are sufficiently rugged and robust to allow for transfer to other laboratories.

C. Early-Phase Methods

Early-phase method development typically begins with the receipt of drug substance from laboratory-scale synthesis and purification. Along with the API, the following information should be requested (or generated):

1. Physicochemical properties of the API (structure, solubility data, $pK_a(s)$, UV spectra, chirality, etc.)
2. Synthetic route used in production
3. Potency (or expected range of potency)
4. Intended formulation(s)

Materials such as excipients and related substances that may be present as impurities (starting materials, intermediates, etc.) should also be obtained, where available.

Examination of the synthetic route used in production allows for the prediction of potential residual synthetic impurities present in the drug substance. The API structure allows for the postulation of degradation pathways via hydrolytic, oxidative, catalytic, and other mechanisms. Both of these evaluations serve to facilitate the interpretation of (subsequent) identification tests. An examination of the physicochemical properties also allows for the rational establishment of method screening experiments by precluding certain conditions. For example, the use of normal-phase HPLC will be eliminated if the API is a salt or shows limited solubility in nonpolar organic solvents. Similarly, if the API (or suspected related substances) has no significant chromophore above 250 nm, the use of tetrahydrofuran (THF) and other solvents as mobile-phase components is severely limited.¹⁵ For compounds with an ionizable group, variation of pH will have considerable influence on elution behavior and can be exploited to optimize the selectivity of a reversed-phase separation.

Prior to initiating method development, it can also be useful to review the literature for information on related classes of pharmaceuticals, particularly to determine if attributes of the molecules prevent certain steps of the method development process to be conducted. A recent review of pharmaceutical and related drugs¹⁶ provides a comprehensive biography of analytical methods developed for various drug types.

In comparing normal phase to reversed phase, several general attributes can be noted. Reversed-phase HPLC provides better separation between compounds varying in alkyl carbon number and elution is in order of decreasing polarity. Normal-phase HPLC provides better resolution of compounds differing in polar substituents and for achiral isomers⁴ and elution is in order of increasing polarity. However, more substantial *a priori* prediction of which specific column will be most suitable for a given API and related substances has remained elusive.

Because an *a priori* choice of column cannot be made, it is useful to evaluate a set of columns, selected on the basis of the previous discussion, to provide potentially orthogonal selectivities. The critical performance parameters for reversed-phase columns are influenced by both the silica packing material and the bonded-phase synthesis. Variations in silica include particle size, silica type (porous versus pellicular), pore size, purity, surface area, and surface chemistry. Reversed-phase bonded phases vary with respect to the chemical nature of the bonded phase (C18, C8, phenyl, cyano, etc.), monomeric versus polymeric bonding, and whether or not an end-capping procedure was used in the manufacturing process.¹⁷ Collectively, these differences lead to differences in surface area coverage and percentage carbon load. To select columns for screening experiments, it is desirable to choose three or four reversed-phase columns that differ in chemistry.¹⁸ Normal-phase separations can be achieved using cyano or diol columns. Other stationary phases are also available, but generally provide poorer stability. For both separation modes, 250×4.6 mm ($5 \mu\text{m}$) columns offer the greatest separation efficiency and are preferred for initial experiments.

The selection of mobile phases to be used in conjunction with these columns is dependent on the mode of chromatography (reversed phase versus normal phase) and on the physicochemical properties of the API (and related substances). However, in all instances, it is important to ensure that the API and *all* related substances can be monitored and are separated. Accordingly, it is of paramount importance that the initial chromatographic conditions elute all the individual components from the column and that no components are eluted at the solvent front (i.e., all compounds of interest are retained). In practice, this dictates the use of broad (5–90% strong solvent in 60 min) gradients.

Neutral Solutes. In the reversed-phase mode, water is used as the weak solvent and acetonitrile, methanol, or THF (where applicable) is used as the strong solvent. (It is notable that the addition of acid or base to the mobile phase used for neutral molecules does not preclude separation, and, as such, the approach outlined later for ionizable components is equally viable.) In normal-phase HPLC, hexane is used as the weak solvent and isopropanol is used as the strong solvent. To change selectivity based on the strong solvent, isopropanol may be replaced (in part) with methylene chloride, methyl *t*-butyl ether, or ethyl acetate. However, note should be made of the relatively high UV cutoffs of these solvents when UV detection is to be used and precautions should be taken to ensure solvent miscibility across the range of the gradient.¹⁵

Acidic/Basic Solutes. Reversed-phase separations are conducted as described for neutral solutes with the exception that the aqueous component (or both components) of the mobile phase is modified with acid/base or buffer. Modifying the aqueous phase such that the pH is a minimum of 2 pH units above, or a minimum of 2 pH units below, the solute $\text{p}K_{\text{a}}$ allows for ionizable compounds to be evaluated in either charge state. For basic compounds, suppression via a change in pH can be more troublesome due to the inherent instability of silica gel in basic media. However, considerable efforts over

the past several years have focused on the development of base-stable packing materials^{19,20} and have largely eased the problem. Currently, the pH modification should ideally be achieved using volatile acids, bases, or buffers such as acetic acid, formic acid, ammonium hydroxide, or acetic acid/ammonium acetate or formic acid/ammonium formate buffers, to allow for MS detection. Methods for the postcolumn removal of nonvolatile buffers are, however, becoming available.²¹

To obtain as much information as possible about the specificity of the proposed conditions, screening experiments should be conducted on the available drug substance batch(es), available excipients, and drug substance stressed under accelerated temperature, humidity, oxidation, and photolysis conditions and in basic and acidic media.²² Approaches for conducting these studies have been reviewed by Singh and Bakshi.²³ Due to differences in the inherent stability of different NCEs, it is difficult to give exact guidelines regarding the concentrations of stressing solutions and exposure times and temperatures. However, it is desirable to achieve approximately 20% degradation under each decomposition condition to generate readily detectable quantities of degradation products. Note should be made that the decomposition occurring under harsh conditions may not be via the same mechanism as observed at ambient conditions for prolonged periods and, as such, forced-decomposition studies provide only a preliminary estimate of the degradation compounds that may be obtained.

To conduct the method screening process, each mobile phase is run on each column, excluding combinations that are incompatible. This can be performed in automated fashion with modern HPLC systems using a column-switching valve^{18,24} and running the separate candidate mobile phases sequentially on each column. To set the additional HPLC variables, it is recommended that the column set at 35–40 °C to reduce mobile-phase viscosity and improve separation efficiency (*N*) versus ambient conditions.

During the initial runs, designed to identify candidate separation conditions, it is extremely useful to use photodiode array (PDA) detection or a combination of PDA and MS detection. The use of PDA detection will allow for UV spectra to be obtained for each analyte in the sample. This provides five primary advantages over single-wavelength UV detection, as follows:

1. Where the solute UV spectra are different, peak tracking during method development is conveniently achieved using the spectra.
2. UV maxima for individual components are readily determined.
3. The monitoring of low wavelengths (205–210 nm) maximizes the probability that all eluting components are observed.
4. Although low in identification value compared to other spectroscopic methods, UV spectra may be used to assist in structural elucidation of unknown peaks.
5. The purity of each peak may be evaluated by overlaying spectra at the front, apex, and tail of each peak or by using software to ratio the wavelengths at various time points over the course of the peak.

Although these are advantages over single-wavelength UV detection, it should be emphasized that peak purity measurements by PDA detection are

not confirmatory. A better method is to use PDA detection in conjunction with MS detection (Section III.D). MS allows for more substantial identification of unknown peaks and comparison of MS spectra across the parent peak allows for the determination of peak purity for compounds with similar UV spectra. However, the use of PDA detection alone for scouting runs is not without merit. Potential condition sets can be excluded from consideration, thereby minimizing the number of samples requiring MS evaluation.

For initial runs, the samples should be prepared in a solvent system that is as close as possible to the initial gradient conditions and injected at an injection volume of 15–30 μl to maximize quantitative reproducibility without volume overloading the column. Ideally, the mass injected should allow for the related substances to be observed at the limit of quantitation at a concentration of 0.02% or less to ensure that even minor compounds are observed. Assuming equal response factors of the API and related substances, this can be determined empirically by diluting the API to 0.02% of the proposed operating concentration and verifying that the criterion is met. For samples that are not soluble in the recommended solvent system, a smaller injection volume (5 μl) may be necessary to prevent deleterious peak shapes that may result when the sample solvent contains a higher percentage of strong solvent than the initial mobile-phase conditions.

Chromatograms obtained from the scouting runs should be evaluated on the basis of the separation observed between all components. The conditions providing the largest number of resolved peaks should be chosen as a candidate method for further optimization. However, the results obtained from other sets of conditions should also be examined, particularly with respect to elution order of the components. Ideally, at least one method that provides orthogonal resolution (difference in the elution order or band spacing of the components) should be identified as a supportive method to evaluate the performance of the candidate method during subsequent phases of drug development. Orthogonal GC, SFC, or CE methods may also be developed for this purpose.

Following selection, the candidate method may be refined to maximize resolution between components by using segmented gradients instead of the linear gradients used for the initial experiments. For example, if all components elute early in the chromatogram, it may be useful to decrease the rate of change of the strong solvent at the beginning of the run and to increase the rate at the end of the run. However, the use of a broad gradient should be continued to maximize the probability that all components generated in subsequent experiments can be monitored.

Although no formal validation, beyond showing specificity using PDA (and MS) detection, is required at this point in development, it is useful to reanalyze the prepared samples at various time intervals to establish that no new peaks are observed and that there is no loss of related substances. This establishes the time period for which the solutions may be retained and, where this period is prohibitively short, suggests that reexamination of the sample solvent system is warranted.

Following selection of a candidate method, further stability studies are desirable for both drug substance and drug product (or drug substance mixed with excipients, if a dosage form is not available). These studies should be con-

TABLE I Stress Conditions for the Assessment of Drug Product and Drug Substance Stability

Stress parameter	Stress conditions
Temperature	80 °C, 70 °C, 60 °C, 50 °C
Hydrolysis	60 °C / 80% relative humidity
	40 °C / 80% relative humidity
Oxidation ^a	80 °C / 300 psi oxygen
	70 °C / 300 psi oxygen
	60 °C / 300 psi oxygen
	50 °C / 300 psi oxygen

^aExperiments conducted in a calorimetry bomb.

ducted in the solid state by exposing the drug substance and drug product to relative humidity, temperature, and oxygen conditions that are closer to ICH storage conditions²² than the harsh conditions used in forced-decomposition studies. A typical study may be set up as detailed in Table 1. To facilitate subsequent identification of degradation products and to obtain samples for subsequent method development, sufficient material should be placed on stability. Samples set up as indicated should be sampled and analyzed intermittently over the course of approximately 12 weeks. To evaluate the influence of light, drug substance and drug product should be exposed to a light source that produces an output similar to the D65/ID65 emission standard.²⁵ Samples should ideally be exposed at 500–1000% of the ICH specified 1.2 million lx · h at an integrated near-UV energy of not less than 200 W · h/m².

The use of multiple time increments allows for the attribution of any observed peaks as degradation products if the peaks are observed to increase in size as a function of time. The use of multiple temperatures allows for the confirmation that degradation products observed at elevated temperatures are also observed at lower temperatures, albeit at lesser levels, and supports the fact that the degradation mechanism occurs at conditions approaching ambient. Further evaluation can be conducted using kinetic modeling and Arrhenius plots to estimate the formation of individual degradation products under ICH stress conditions. Degradation products observed from forced decomposition, which are not observed in the solid state, may generally be excluded from further consideration.

As was the case for the forced-decomposition samples, the solid-state stability samples should be monitored using both PDA and MS detection to ensure that specificity of the candidate method is maintained. Analysis of the samples using an orthogonal method to further verify specificity is also recommended. If the method is, at this point, shown to provide separation among the API, all drug synthesis process impurities, and all degradation products, no additional method development is required at this juncture. When coelution is observed between components, development using additional column/mobile-phase combinations may be considered (see Section III.E). Alternatively, the use

of two methods that collectively allow for the monitoring of the API, all drug synthesis process impurities, and all degradation products can be implemented for further early-phase studies. It should be reemphasized that it is typically difficult to separate more than 15–20 compounds in a single HPLC run^{13, 14} and that for samples that fall into this category the use of two methods is viable.

Following the establishment of specificity, the method(s) should be validated to allow for use in release and stability testing. Such validation is typically less stringent than for final methods (see Chapter 12), but should demonstrate specificity, linearity, range, accuracy, and analysis repeatability for the API. For related substances, specificity should be demonstrated and the limit of detection (LOD) and limit of quantitation (LOQ) should be established for the API to serve as surrogate values for the LOD and LOQ of impurities for which authentic substances are not available. To achieve a sufficient LOD and simultaneously keep the API in the linear dynamic range of the detector, it may be necessary to use different sample concentrations for the analyses of the API and related substances. It is additionally beneficial to repeat the separation on new columns from different batches to ascertain that the separation obtained can be maintained column to column.

In addition to supporting stability and release evaluation of clinical supplies, the method(s) developed at this juncture should also be used to support formulation studies and to evaluate the impurity profile of new drug substance batches. When the formulation or synthetic route is modified, supportive orthogonal methods, identified during the initial method development, should be run to verify the validity (specificity) of the release and stability method. When the supportive method demonstrates that the initial method is inadequate, the supportive method should be validated to allow for its use in complementing the initial method for release and stability testing. Concurrent with these activities, significant synthetic process impurities and degradation products should be identified and isolated or synthesized.

The initial method(s) should be maintained until the synthetic route and formulation(s) are finalized. Stress studies in the solid state, as outlined previously, should then be conducted for both drug substance and drug product to verify that the modifications do not change the degradation pathways. Following critical examination of the data from impurity profiling and degradation studies, an assessment can be made regarding which impurities and degradation products should be monitored in the final methods (Section III.E). The methods developed during early-phase studies should, however, be maintained for subsequent troubleshooting.

D. High-Performance Liquid Chromatography/Mass Spectrometry and High-Performance Liquid Chromatography/Nuclear Magnetic Resonance

Emphasis was placed on the extensive use of MS detection as the primary method for assessing the structure of unknowns generated during development. Comprehensive structure elucidation may require not only MS but also MS/MS or MS techniques coupled with NMR. The general principles of LC/MS and variations between instrumentation have been discussed in detail

elsewhere.^{26,27} Most commonly, MS is performed using electrospray ionization (ESI) or atmospheric-pressure chemical ionization (APCI) coupled with single (MS) or triple (MS/MS) quadrupoles. NMR, widely considered the most powerful technique for structural elucidation, is used most frequently in combination with MS and is especially useful in the identification of isomers that give the same MS fragmentation patterns. Although HPLC/NMR is evolving to become a routine technique, it requires large detection volumes and stop-flow detection for trace analysis and deuterated mobile-phase solvents.²⁸

Numerous papers have been published to illustrate the role of LC/MS, LC/MS/MS, and LC/NMR in early-phase studies. Thomasberger *et al.*,²⁹ for example, have used HPLC/MS, HPLC/MS/MS, and HPLC/UV to address the impurity profile of a glycoprotein Iib/IIIa antagonist. A goal was to elucidate the structure of every impurity generated during scale-up activities at levels of 0.1% or greater relative to the API. As a starting point in method development, the synthetic pathway was critically examined, precursors were obtained as reference standards, and potential by-products were hypothesized to facilitate subsequent identification.

For analyses, two sets of HPLC conditions were used, depending on whether UV (285 nm) or MS (electrospray ionization on a triple quadrupole system) was to be used for detection. For MS detection, analyses were conducted using a 125 × 4 mm (5 μm) Lichrospher 60 RP-Select B column. Eluent A was 800 ml water/200 ml acetonitrile/3.08 g ammonium acetate adjusted to pH 6.5 with acetic acid. Eluent B was 500 ml water/500 ml acetonitrile/1.93 g ammonium acetate adjusted to pH 6.5 with acetic acid. The gradient was run at 0.5 ml/min as follows: from 0–25.0 min, 100% A; from 25.0–35.0 min, 100% A–100% B; from 35.0–45.0 min, 100% B; from 45.1–55.0 min, 100% A.

During evaluation of synthetic batches, unknown compounds were identified using MS with reference to the hypothesized products. The compounds observed (Table 2) included a trace contaminant coeluting with another impurity under the HPLC/MS conditions (EMD 151 201) and an impurity with a mass-to-charge range (m/z) of 462 that could be either the ethylurethaneethyl ester or the methylurethaneisopropyl ester based on the synthetic scheme. Structural elucidation via MS/MS clearly illustrated that the peak of interest was the isopropyl ester analogue. Confirmation of new impurities was achieved via synthesis and spiking experiments.

For UV detection, analyses were conducted using a 250 × 4 mm (5 μm) Lichrospher 60 RP-Select B column. Eluent A was 800 ml water/200 ml acetonitrile/11.04 g sodium dihydrogen phosphate adjusted to pH 6.5 with NaOH. Eluent B was 500 ml water/500 ml acetonitrile/6.90 g sodium dihydrogen phosphate adjusted to pH 6.5 with NaOH. The gradient was run at 1 ml/min as follows: from 0–17.0 min, 100% A; from 17.0–25.0 min, 100% A–100% B; from 25.0–35.0 min, 100% B; from 35.1–55.0 min, 100% A. A chromatogram of a synthetic batch spiked with the identified impurities, using the UV conditions, is shown in Figure 1. Retention times given in Table 2 are for the UV method.

Zhao *et al.*³⁰ have similarly used LC/MS and LC/MS/MS for the identification of degradation products in humidity-stressed Losartan (a non-peptide

TABLE 2 HPLC/UV Retention Times and Structures of EMD 122 347 (Glycoprotein lib/IIIa Antagonist) and Related Impurities

Retention time (min)	Name	Formula
2.49	EMD 132 338	
4.25	EMD 137 763	
8.35	EMD 96 619	
11.33	EMD 99 841	
15.23	EMD 122 325	
18.37	EMD 142 676	
20.32	EMD 171 966	
23.05	EMD 122 347	
26.17	EMD 132 338	
27.31	EMD 112 921	
29.25	EMD 137 762	
30.48	EMD 128 025	

Source: Reprinted with permission from Thomasberger, A., Engel, F., and Feige, K. *J. Chromatogr. A* 854:13, 1999.

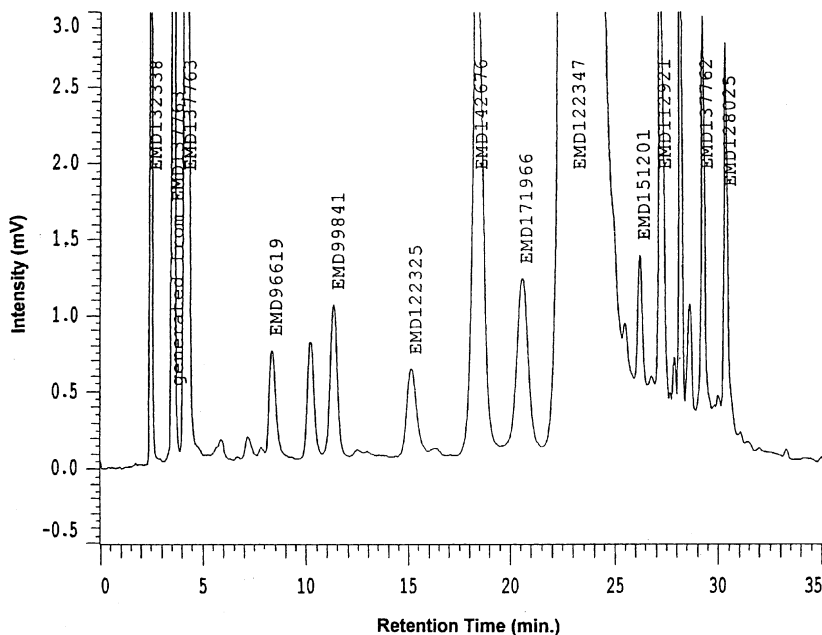

FIGURE 1 HPLC/UV separation of EMD 122 347 spiked with identified impurities. Conditions are given in the text. Reprinted with permission from Thomasberger, A., Engel, F., and Feige, K. *J. Chromatogr., A* 854:13, 1999.

angiotensin II receptor blocker) tablets. MS was performed using APCI in the positive-ion mode, and MS/MS was conducted using a triple quadrupole. Using this approach, three degradation products were assigned as the aldehyde and dimeric derivatives of Losartan. To substantiate the identities, MS/MS spectra of the unknowns were compared with those of authentic substances.

Peng *et al.*³¹ have used HPLC/UV, LC/NMR, and LC/MS for the identification of the degradation products of the protease inhibitor, *N*-hydroxy-1,3-di-(4-ethoxybenzenesulfonyl)-5,5-dimethyl-(1,3)cyclohexyldiazine-2-carboxam-

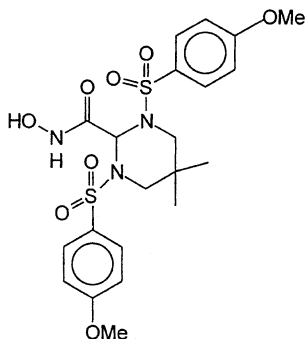

FIGURE 2 Chemical structure of PGE4410186. Reprinted with permission from Peng, S. X., Borah, B., Dobson, R. L. M., Liu, Y. D., and Pikul, S. *J. Pharm. Biomed. Anal.* 20:75, 1999.

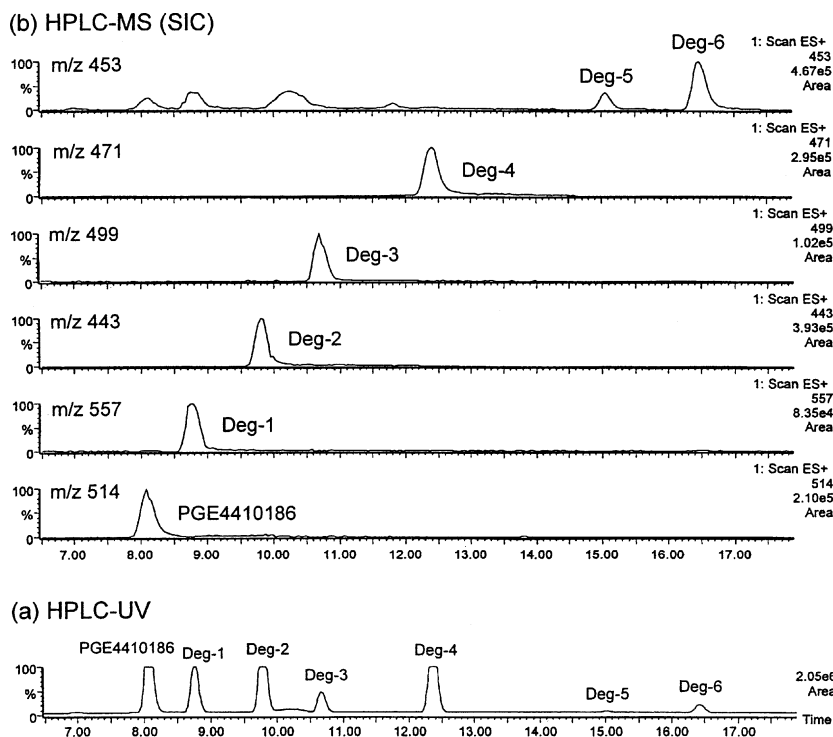

FIGURE 3 HPLC/UV (a) and HPLC/MS (b) chromatograms of PGE4410186. Conditions are given in the text. Reprinted with permission from Peng, S. X., Borah, B., Dobson, R. L. M., Liu, Y. D., and Pikul, S. J. *Pharm. Biomed. Anal.* 20:75, 1999.

ide (PGE4410186; Fig. 2) in dosage formulations. HPLC was performed on a Waters Symmetry C18 column (150 × 3.9 mm) using a 20-min linear gradient from 35:65:0.1 (v/v/v) acetonitrile/water/formic acid to 80/20/0.1 (v/v/v) acetonitrile/water/formic acid at 1 ml/min. Analyses of a 10 mg/ml sample were achieved by injection of 5 μ l.

Chromatograms obtained using HPLC/MS (ESI in the positive-ion mode) and UV at 240 nm were obtained in the same run by splitting the effluent 9:1 (UV:MS) and are shown in Figure 3. MS data based on the molecular weights of adducts formed in 30-V ESI spectra and high-cone-voltage (80 V) ESI spectra allowed for the tentative identification of several of the degradation product peaks. However, for Deg-4, the data were consistent with the inclusion of an alcohol moiety, but the tautomeric form was also viable; Deg-5 and Deg-6 were of the same molecular weight and yielded identical fragmentation patterns, indicating that they were likely structural isomers.

To confirm the tentative assignments of the degradation products and to further elucidate the structures of Deg-4, Deg-5, and Deg-6, HPLC/NMR analyses were performed. Conditions were as described for HPLC/UV and MS, with the exception that NMR-grade acetonitrile and deuterated water were used as mobile-phase components. The injection volume was additionally increased to 25 ml to place 5–50 μ g of each degradation product on column.

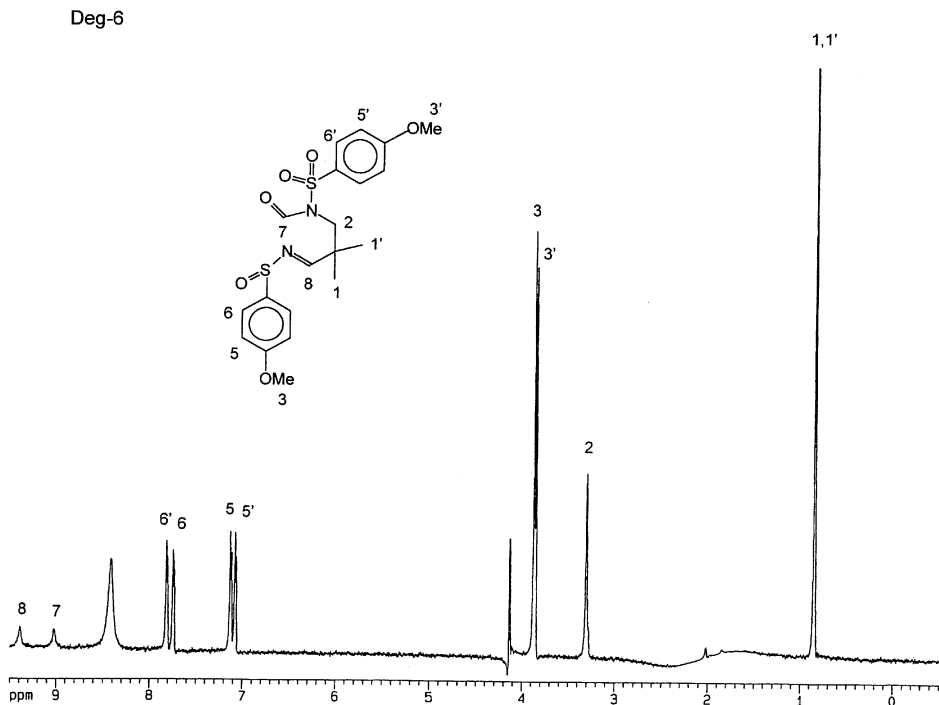
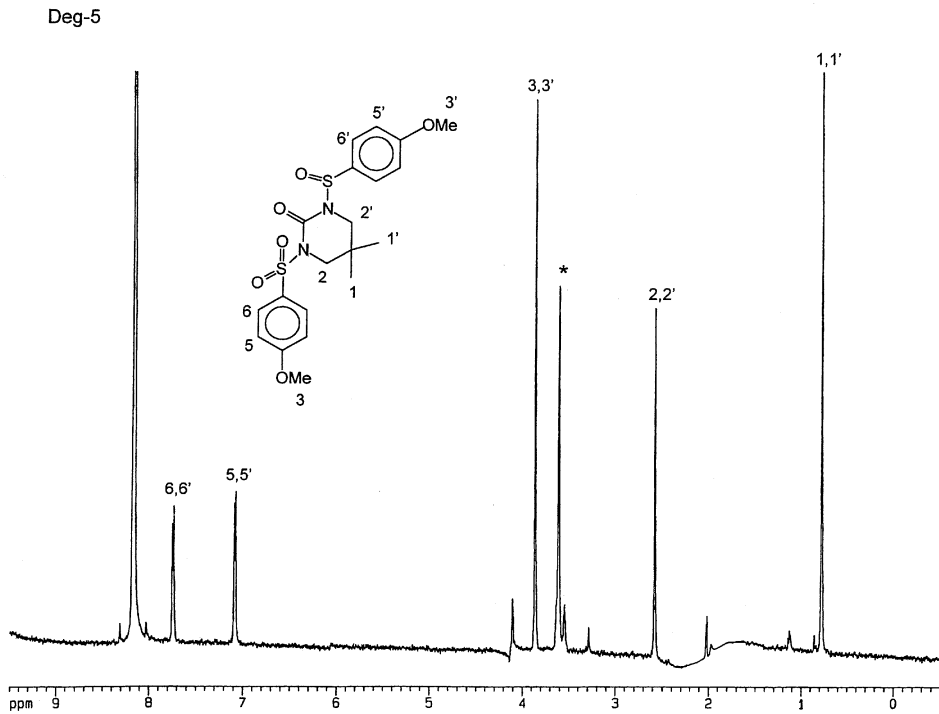

FIGURE 4 NMR spectra of PGE4410186 degradation products Deg-5 and Deg-6. Structures based on the spectra are inset. Reprinted with permission from Peng, S. X., Borah, B., Dobson, R. L. M., Liu, Y. D., and Pikul, S. *J. Pharm. Biomed. Anal.* 20:75, 1999.

NMR spectra were obtained in the stop-flow mode by stopping the HPLC flow while the NMR was acquiring data on the peak. For Deg-4, the NMR spectrum was not consistent with an alcohol and pointed to the tautomeric open-ring aldehyde as the degradation product. The NMR spectra of Deg-5 and Deg-6 are shown in Figure 4. Structures, based on the combined MS and NMR data, were assigned as shown in the figure insets.

E. Late-Phase Methods

Unlike early-phase methods, the criteria for late-phase release and stability studies are well defined by regulatory guidelines (see Chapter 12). Although it has been emphasized earlier that discussion of validation issues will not be a primary focus of this chapter, method development must be performed in the context of meeting regulatory expectations. Minimal discussion of regulatory considerations will, therefore, be interjected, where applicable, to the discussion of method development.

In late-stage development, the synthetic route and drug formulation should be finalized, and the development analyst is faced with developing a method to separate known chemical entities. At this point, a distinction can be made between the drug substance method and the drug product method because the compounds to be separated in each mixture may be different (Section III.B). The development chemist is armed with method information from the early-phase studies, solute acid/base behavior, UV spectra of the analytes, and solubility and solvent compatibility data, and has a greater latitude in selection of mobile-phase composition (as compatibility with MS detection is no longer a key consideration). However, additional criteria must be considered. To optimize throughput, method run times should be as short as possible, and to facilitate method transfer, the use of isocratic conditions is strongly preferred over gradients. When gradients are necessary, linear gradients are preferred to segmented gradients.

With the composition of the sample to be separated known, late-phase methods can follow conventional, systematic optimization,⁴ although several of the optimization steps may be precluded on the basis of existing information. The following approaches assume that the column to be utilized is known. However, the experimental design can readily be repeated using various columns to ascertain that the optimum column is selected. The column(s) for evaluation should be chosen with the goal in mind that it should be possible to replace the column with a column from a different manufacturer and obtain the same separation. This consideration is particularly important when the method is to be used in different geographical regions, where column availability may differ, and as a contingency plan in case the supplier stops manufacture of the column. Columns marketed to “provide unique selectivity” should be avoided.

As discussed, reversed-phase columns differ in both the silica packing material and the bonded phase. In fact, over 600 different brands of packing material are currently available.¹⁷ Whereas differences between columns can lead to problems in identifying an equivalent column, it must be stressed that they are also responsible for differences in separation behavior; accordingly,

the differences may be exploited in developing methods. Thus, although there has been considerable discussion of the merits of standardizing C18 columns, current consensus is that an unregulated choice in column is favorable.³² To ensure that candidate replacement columns can be identified, it is, however, prudent to examine the variables in both silica and bonded-phase chemistry to ensure that other columns with similar characteristics can be obtained from an alternate supplier. Neue *et al.*³³ have developed a procedure for the classification of reversed-phase packings. The interested reader is referred to this work and the references therein for a more detailed discussion.

With manufacturer-to-manufacturer variability considerations in mind, a good starting point for late-phase method development studies is to choose a 5- μm 250 \times 4.6 mm i.d. column with a pore size of 80–100 Å and a particle surface area of 150–350 m²/g.⁴ Ideally, the column should also be available in shorter lengths (3, 5, 7.5, 10, and 15 cm) and with 3- μm packing material of the same pore size and surface area, such that the separation may be easily optimized following initial runs.

Two popular approaches are frequently used in method development: (1) mobile-phase optimization based on sequential isocratic runs and (2) mobile-phase optimization based on gradient runs. As specified, a primary goal of late-phase method development is to achieve isocratic operating conditions. Accordingly, the following approaches focus initially on the optimization of isocratic conditions. A discussion of gradient optimization follows for mixtures not amenable to isocratic separation.

a. Reversed-Phase High-Performance Liquid Chromatography

1. Mobile-Phase Optimization Based on Isocratic Runs

The isocratic method development approach⁴ is based on first running the sample, at 1 ml/min and 35–40 °C, in 100% acetonitrile to ascertain that all components elute and that the separation is amenable to reversed-phase HPLC (all peaks should be unretained). Subsequently, the percentage acetonitrile is reduced in 20% increments, using water as the other mobile-phase component, until the k' range of the solutes is approximately 0.5–20. For ionizable compounds, the aqueous component of the mobile phase may be replaced with 25 mM pH 2.5–3.0 potassium phosphate buffer or, when using high-pH-compatible columns, with pyrrolidine or other basic buffers.^{19, 20} Where the condition $0.5 < k' < 20$ cannot be obtained, a column that is substantially less retentive than the column(s) initially evaluated, such as a cyano column, should be similarly evaluated. If this approach also fails to provide a solute elution range of $0.5 < k' < 20$, efforts should shift to optimization of a gradient method.

For samples where the $0.5 < k' < 20$ criteria is met following optimization of the percentage acetonitrile, approximately equal strengths of methanol/water and THF/water are evaluated to determine selectivity differences between solvents. Corresponding strengths of various mixtures of acetonitrile/water, methanol/water, and THF/water are given in Figure 5a. An approach for fully mapping the effects of the various solvent systems is given in Figure 5b. The numerical points in the figure correspond to the following

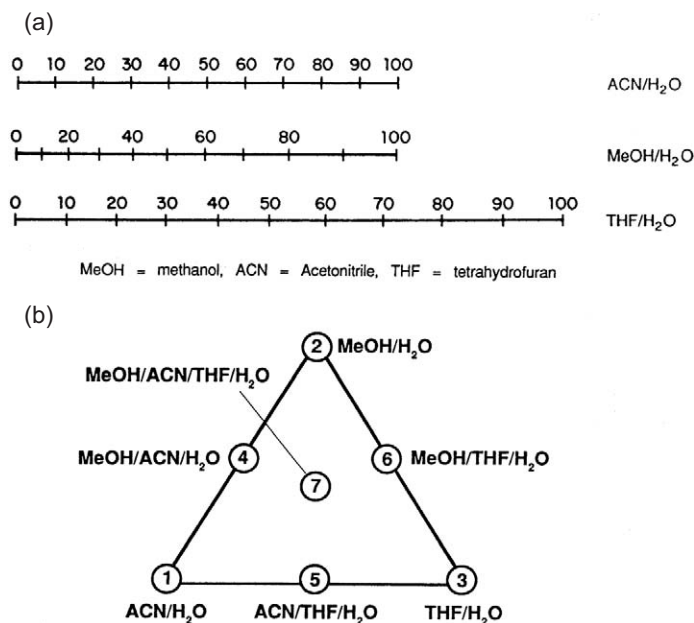

FIGURE 5 (a) Equivalent solvent strengths of acetonitrile/water, methanol/water, and THF/water. (b) Experiments for optimization of selectivity in reversed-phase HPLC. Reprinted with permission from Snyder, L. R., Kirkland, J. J., and Glajch, J. L. *Practical HPLC Method Development*, 2nd ed. Wiley, New York, 1997.

(1) methanol/water in the proportions required for a k' range of 0.5–20; (2) acetonitrile/water in the proportions required for a k' range of 0.5–20; (3) THF/water in the proportions required for a k' range of 0.5–20; (4) a 50/50 mixture of the solvent systems used in (1) and (2); (5) a 50/50 mixture of the solvent systems used in (2) and (3); (6) a 50/50 mixture of the solvent systems used in (1) and (3); and (7) a 33/33/33 mixture of the solvent systems used in (1), (2), and (3). Following the establishment of the solvent map, further refinements in the mobile phase can be achieved by using additional mixtures. For example, if it is desirable to obtain a chromatogram that is intermediate between conditions (1) and (7), a 50/50 mixture of these solvents may be evaluated.

The selectivity, as well as k' , may also be influenced by the percentage of water in the mobile phase. Because it is generally desirable to use acetonitrile or methanol-based mobile phases, it is, therefore, also useful to vary the percentage of water in acetonitrile and methanol systems while maintaining the requisite k' range.

If development as outlined meets the initial goal of separating the compounds, it is tempting to assume that method development is complete at this juncture. However, although both the column chemistry and the mobile phase have been selected, further optimization of column length, particle size, and flow rate is warranted (see Section III.E.b). If the separation provides the requisite k' range, but does not adequately separate all components, the approach may be repeated using additional column types (phenyl or cyano columns).

Alternatively, particularly for achiral isomers,³⁴ the influence of temperature under each set of conditions should be evaluated.

For acids and bases, large changes in selectivity may also be observed as a function of pH, and it is possible that repeating the outlined approach at additional pH conditions will be effective. However, in such studies, it is highly desirable to vary the pH by 0.2 pH units for any candidate conditions to verify robustness before proceeding.

An additional approach, applicable to bases and the mixture of acids and bases, is ion pairing.⁴ Using this approach, the aqueous portion of the mobile phase is buffered to suppress ionization of acids (as before) and to promote full ionization of bases. Subsequently, a reagent such as hexane sulfonate is added to the aqueous buffer at a concentration of 50–100 mM to form a dynamic ion pair with the cationic base and to thereby increase the retention of the base. Variation in the retention of bases is influenced by the amount of organic solvent (methanol is typically used for solubility reasons), the concentration of ion-pairing reagent, and, as an additional variable, the temperature. This leads to a desirable situation with respect to manipulating selectivity, but the influence of multiple parameters on the separation makes control of the separation more difficult, and extensive robustness testing prior to finalizing conditions is frequently necessary.

A particular problem associated with the separation of basic compounds both in the ion-pairing mode and in other forms of HPLC is tailing due to the interaction with the silica gel. Such interaction is typically curtailed by the addition of 20–30 mM triethylamine to the mobile phase.

2. Mobile-Phase Optimization Based on Gradient Runs

Specific guidelines have also been published^{4, 35, 36} for selecting a mobile phase in reversed-phase HPLC based on gradient elution. Using this approach, an initial run is performed using 5–100% acetonitrile in 60 min (the weak solvent is water or buffer as outlined previously). If no peaks elute at less than 2 times the column dead volume (t_0) and if the retention range is less than 40% of the gradient time (i.e., all the peaks elute within a 25-min window of the 60-min run), the separation is typically amenable to isocratic separation and the method development may be conducted as specified for isocratic conditions. The percentage of acetonitrile required to obtain the correct solvent strength may, as a first approximation, be taken from the gradient by calculating the percentage of acetonitrile passing through the column at the retention time of the final component.

b. Normal-Phase High-Performance Liquid Chromatography

Normal-phase separations can be developed using the same philosophical approach outlined previously.⁴ Initial runs should be conducted using 100% strong solvent (isopropanol for normal-phase separations) on a 250×4.6 mm (5 μ m) cyano column to ascertain that all components elute at $0.5 < k' < 20$. Subsequently, the percentage of isopropanol should be decreased by successive factors of 2 using hexane as the weak solvent. A gradient of 100% hexane to 100% isopropanol may alternatively be used to estimate if gradient conditions are necessary or to approximate the required percentage of isopropanol.

To change selectivity based on the strong solvent, isopropanol may be replaced with methylene chloride, methyl *t*-butyl ether, or ethyl acetate (separate k' optimization is required). However, note should be made of the relatively high UV cutoffs of these solvents when UV detection is to be used. As an alternative to cyano columns, diol columns may be investigated as before. Other stationary phases are also available, but generally provide poorer stability. Triethylamine or acetic acid may be added to the mobile phases to curtail tailing problems.

For samples where the criteria of $0.5 < k' < 20$ cannot be achieved using reversed-phase or normal-phase HPLC, the use of gradient elution chromatography should be evaluated. Initial efforts should focus on the determination of the initial and final percentage of strong solvent and the gradient steepness (change in percentage of strong solvent/time). Such development is greatly facilitated by commercially available software such as DryLab.³⁷ Using the software approach, two gradients of different steepness are run and the respective retention times of the components entered. This allows for the prediction of the resulting chromatograms using different gradient rates and different initial and final solvent compositions. The same approach may be taken experimentally, but the use of software greatly reduces the number of experiments required. If adequate resolution is not obtained following the initial mobile-phase optimization, the two runs can be repeated using different temperatures, different solvents, or different columns and the software simulation repeated to determine the optimum conditions.

As noted, if the initial goal of separating the compounds has been achieved using isocratic or gradient conditions, it is tempting to assume that method development is complete at this juncture. Although both the column chemistry and the mobile phase have been selected, this represents only the thermodynamic (α and k') contribution to resolution. If resolution beyond the requisite resolution of 2.0 is obtained between all components, the opportunity exists to reduce analysis time via N [see Eq. (1)]. For example, the use of a shorter column, the use of a shorter column packed with smaller particles, and the use of faster flow rates should be investigated to improve analysis times. Such optimization of HPLC methods may again be facilitated by use of software products such as DryLab (LC Resources, Walnut Creek, CA), ICOS (Agilent Technologies, Wilmington, DE), DIAMOND (ATI, Cambridge, UK), PESOS (Perkin-Elmer, Norwalk, CT), among others.^{4,37} The software packages perform the mathematical transformation associated with the change of column length, particle diameter, and flow rate and can predict the chromatograms that would result under candidate conditions. Conditions predicted as optimal by the software should be confirmed experimentally, but trial-and-error experimentation can be reduced significantly.

In addition to choosing separation conditions, both the injection volume and the sample concentration must be chosen during method development. These must be considered with respect to the detection used. For the simultaneous detection of API and related substances, the detector should minimally be able to quantify compounds from 0.1% (limit of quantitation) to 130% of the concentration of the API for compliance with ICH guidelines.⁷⁻¹⁰ This requires the detector to have a minimum linear dynamic range (LDR) of 1300, assuming equal responses of the API and related substances. For samples where

the response for any related substance is less than that of the API, a proportionally larger LDR is required. Literature values⁴ suggest typical LDRs of 20,000 are possible for UV detection. However, such a linear dynamic range is obtained only under ideal conditions.

Different techniques exist for the determination of the limit of quantitation (LOQ).^{38,39} Taking the simplest definition of 10 times the signal-to-noise ratio, it is apparent that the linear dynamic range is reduced by baseline drift stemming from gradients. The upper range of linearity will be reduced by an amount corresponding to the absorption of the mobile phase. Furthermore, differences in dynamic range, detector to detector, exist due to differences in detector designs such as variability in bandwidths.⁴⁰ Thus, although it initially appears trivial to meet the requisite LDR, several criteria must be considered during method development.

To evaluate the LDR following development of a chromatographic separation, it is recommended that linearity be evaluated for the full set of detectors to be used for routine testing by injecting serially diluted API sample. The upper and lower ranges will be defined as the level up to which linearity is obtained and the level down to which the requisite LOQ is observed on the worst-case detectors. If a ratio of the high to low range is less than 1300 (or higher, as discussed previously), restrictions must be placed on the instrumentation suitable for analysis or the method should be revised. Assuming that an LDR of more than 1300 is observed, the mass of analyte injected to achieve the upper limit should be calculated. As this level corresponds to 130% of the proposed mass to be injected, the mass to be injected for routine use is given as $100/130 \times$ the upper range mass. To achieve optimum reproducibility on a variety of autosamplers, injection volumes should generally be set at 15–30 μl . The mass to be injected as determined previously should be introduced using a volume within this range.

In conjunction with separation optimization, the use of automated sample preparation methods, to increase throughput, should be investigated for late-stage methods. In general, it is preferable to develop the automated sample preparation procedure prior to validation of the method, to incorporate validation considerations of the automation into the validation scheme.

In a relatively simple application, it may be required for the automated system to (1) weigh sample, (2) dilute, (3) homogenize, (4) filter the sample, and (5) perform subsequent dilutions. This is typically performed automatically by (1) transfer of the sample to a weighing station, (2) gravimetric addition of solvent, (3) homogenization using a homogenization probe for a prescribed period of time at a specified speed, (4) transfer of sample component through a filter membrane, and (5) gravimetric dilution. Guidelines to address development issues for each of these steps have been published.⁴¹

In using gravimetric dilutions as opposed to volumetric dilutions, an accurate determination of solvent density or revision of quantitative calculations to reflect the use of weight/weight is required. The absolute volume (mass) of diluent added to disperse the sample should ideally be large enough for the homogenization probe volume to be insignificant and the solvent volume should be large in comparison to the sample volume. The latter requirement is needed to approach equivalent concentrations between man-

ual methods where sample preparation is typically performed by diluting to volume (Sample + Solvent = x ml) and automated methods where volume is added (Sample + x ml = Total volume).

With respect to sample extraction, it should be emphasized that homogenization using a probe is an intrusive technique. Compatibility is required between the sample probe and extraction vessel and the sample solvent, drug, excipients, and related substances. For this verification, it is frequently desirable to also prepare the development samples manually and to compare chromatographic profiles. Furthermore, the probe must be cleaned between extractions. A cleaning procedure should allow for the most concentrated sample solution to be prepared without carryover above a specified limit. This may be measured by running an analysis blank immediately after the sample.

To set the extraction parameters, it is recommended to vary both the extraction time and the speed of the homogenizer and ensure that small changes in each setting will not adversely affect the extraction. It is also suggested that the test conditions be evaluated using aged samples that may display different physical characteristics and ensuring that the selected conditions minimize heat generation.

To develop an appropriate filtration technique, studies need to be conducted to demonstrate that the analyte and related substances are not retained on the filter, to ensure the absence of membrane extractables and particulates from the filtrate, to determine the filter capacity, and to determine the required filter prewet volume. Mass transfer across the filter can be verified by comparing filtered and unfiltered solutions containing the components of interest. Extractables can be measured from filtration of a blank. To determine the filter capacity, samples containing significantly higher levels of insoluble excipients than expected during routine use should be passed through the filter (the samples may be fortified with placebo to achieve this objective). This may be examined manually prior to using the automated system because filter blockage may lead to system failure.

As a final development consideration, the test solutions generated should be stored under the ambient conditions of the automated system to define the acceptable storage period with respect to both degradation and solvent evaporation.

In addition to validation of the automation, full validation of the chromatographic procedure, as described in Chapter 12, should be conducted for late-phase methods. This should include specification of system suitability parameters to ensure that the performance obtained during method development and validation is maintained during routine use. The system suitability parameters may include specification of acceptable injection repeatability, criteria for resolution between critical pairs, maximum allowable tailing factors, and a means of verifying that the requisite sensitivity is obtained. As recommended by Vander Heyden *et al.*,⁴² system suitability limits are best set following robustness tests.

In addition to specified validation criteria, it is also useful during method development to assess column durability and column-to-column performance. Benchmarks have been established in a series of papers by Kele and Guiochon^{43–46} for short- and long-term repeatabilities and column-to-column

and lot-to-lot reproducibilities. Based on the evaluation of 30 compounds on columns from three different manufacturers, short-term repeatability performed on one column showed separation factors to be reproducible to within 0.04%, retention times to be reproducible to within 0.15%, and efficiency to be reproducible to within 1%. Generally, retention factor reproducibility was within 0.5% column to column and less than 3% batch to batch. Lesser reproducibility was observed for some compounds, but the problem compounds differed between brands. As a result, appropriate column selection can lead to better reproducibility.

Details of numerous late methods have appeared in the literature. The work of Vasselle *et al.*,⁴⁷ detailing a stability-indicating method for Synercid (streptogramin antibacterial agent), provides a representative example of a typical late-phase method. The sterile formulation contains quinupristin and dalfopristin in the ratio of 30:70 (w/w). A chromatogram is shown in Figure 6. The separation was performed using a Lichrospher-100 RP18 cartridge column (125 × 4 mm, 5 μm). Due to the differences in polarity of the two drug substances and the large number of related substances, gradient elution was necessary and was achieved using phosphate buffer/acetonitrile. Specifically, mobile phase A was prepared to contain 20/80 (v/v) acetonitrile/30 mM monobasic potassium phosphate, pH 2.9 (with phosphoric acid); mobile phase B was prepared to contain 65/35 (v/v) acetonitrile/buffer. The mobile phase was run at 1.1 ml/min from 0–66% B in 42.5 min, returned to initial conditions in 1.5 min, and allowed to equilibrate at initial conditions for 5 min between runs. (The 5-min reequilibration was validated as sufficient.) Mobile-

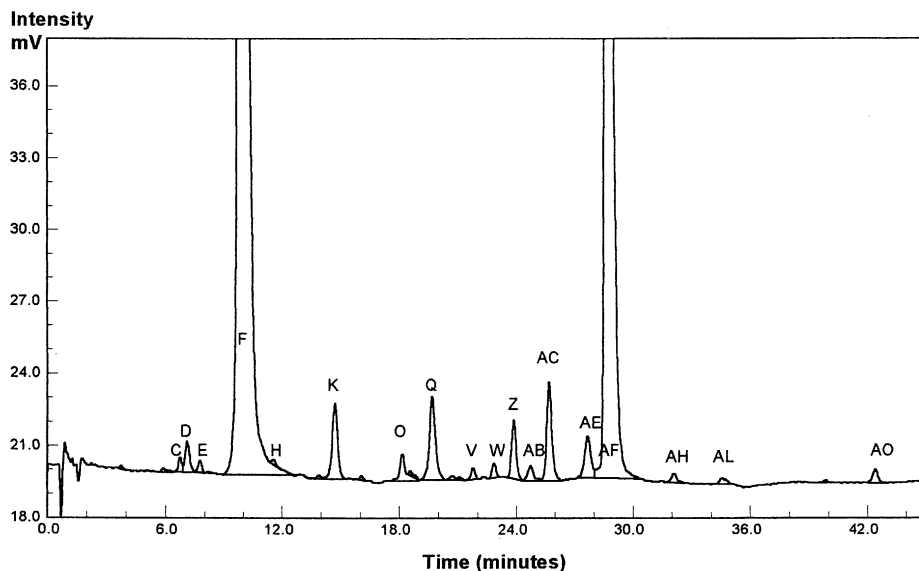

FIGURE 6 HPLC chromatogram of quinupristin, dalfopristin, and related substances. Conditions are discussed in the text. Reprinted with permission from Vasselle, B., Gousset, G., and Bounine, J.-P. *J. Pharm. Biomed. Anal.* 19:641, 1999.

phase pH, column temperature, and gradient slope were optimized using (in part) a computer-aided approach. Additional operating parameters included a column temperature of 40 °C, an injection volume of 10 μ l, and a wavelength of 254 nm. Due to sample stability concerns, samples in the autosampler were maintained at 4–10 °C to provide 36-h stability. Samples were initially prepared to 100 mg/ml in 5% glucose and subsequently diluted to 1 mg/ml with the initial mobile phase (100% A) for injection.

As specified previously, full validation is required for late-stage methods. The paper by Vasselle *et al.*⁴⁷ details each validation step, focusing, in particular on robustness. In their approach, column repeatability and instrument-to-instrument variability were addressed prior to robustness in separate studies. For robustness testing, an experimental design using a “screening” (Taguchi) matrix reduced the testing to 18 experiments. The influences of potassium phosphate concentration, detection wavelength, percentage of acetonitrile in mobile phase A and mobile phase B, gradient steepness, pH, flow rate, and temperature were evaluated. For each experiment, 23 responses were measured: resolution between pairs of critical peaks, signal-to-noise ratio for impurities, drug substance content, related substance levels, number of separated peaks greater than 0.1%, and suitability tests. The effects of each variable on the quality criteria were estimated using statistical analysis software and led to the conclusion that pH, temperature, and wavelength were the critical control parameters. In this context, it was noted that robustness testing is useful to complete prior to method transfer activities to identify potential problems.

As an example of the development of automated sample preparation procedures, Shamrock *et al.*⁴⁸ have described a procedure for automating a validated manual method for Roxifiban (fibrogen receptor antagonist) tablet composite assay. Automated analyses are performed using a Zymark tablet processing workstation II (TPWII) in a 10-step format, as follows:

1. The diluent is gravimetrically dispensed into the homogenization vessel and weight is converted to volume from previously determined solution densities.
2. Tablets placed in a sample tube are weighed and transferred to the homogenization vessel.
3. The homogenization vessel is raised so that the homogenization probe enters the solution.
4. Homogenization is conducted using six 25-s pulses at 10,000 rpm.
5. The solution is allowed to settle for 30 s.
6. A fresh filter is placed in the filter holder and the transfer lines, and the filter is prewetted with the sample. (Notably, this required 5 ml of sample, which is substantially larger than the 1.5 ml TPWII preset.) Subsequently, a 5-ml sample aliquot is collected in an output tube and weighed.
7. A 1:2 dilution is performed by adding a weight of solvent corresponding to the weight of the aliquot in the output tube.
8. The output tube is vortexed for 25 s.
9. The sample from the output tube is transferred to a sample vial for analysis. This step is accomplished by conditioning the transfer line with 4 ml of sample and collecting 3.5 ml.

10. The system is cleaned by washing the homogenizer vessel successively with 100 ml of diluent, 500 ml of water (recycled from a 20-l reservoir), and 100 ml of diluent. The filter transfer path is also washed using the diluent.

On the surface, this appears to be a lengthy process, but the only manual intervention is to load the TPWII with samples, solvents, sample tubes, filters, and vials.

Because the method had been previously validated for manual sample preparation, validation of the automated process required only the demonstration that equivalent samples were prepared by the two methods. To achieve the validation, triplicate preparations were made of product at four different strengths by both methods and assay and impurity levels compared. For assay, a Westlake interval of 0.7% was calculated to show excellent agreement between the data sets. Impurity levels were similarly shown to be statistically equivalent. Carryover was determined by running 20 samples at the highest concentration followed by a reagent blank. Measurement of Roxifiban in the blank showed carryover to be 0.07%.

Numerous additional applications of HPLC for the analyses of pharmaceutical and related drugs have been reviewed elsewhere.¹⁶

F. Chiral Separations

As noted in Section III.A, chiral molecules may be separated into their respective enantiomers using derivatization reagents or chiral stationary phases (CSPs). The primary goal of a chiral separation is typically to determine the enantiomeric ratio of the desired enantiomer:undesired enantiomer. Viewing the undesired enantiomer as an impurity dictates that methods should ideally be able to detect the enantiomers in a ratio of 1000:1 or greater.

Most chiral HPLC analyses are performed on CSPs. General classification of CSPs and rules for which columns may be most appropriate for a given separation, based on solute structure, have been described in detail elsewhere.^{4, 49} Nominally, CSPs fall into four primary categories (there are additional lesser used approaches): donor-acceptor (Pirkle) type, polymer-based carbohydrates, inclusion complexation type, and protein based. Examples of each CSP type, along with the proposed chiral recognition mechanism, analyte requirement(s), and mode of operation, are given in Table 3. Normal-phase operation indicates that solute elution is promoted by the addition of polar solvent, whereas in reversed-phase operation elution is promoted by a decrease in mobile-phase polarity.

Donor-acceptor CSPs are based on a three-point interaction between the solute and the chiral stationary phase of which at least one interaction must be stereochemically specific. Elution is controlled by varying the percentage of polar solvent (i.e., percentage of isopropanol in hexane) or in the reversed-phase mode by varying the percentage of methanol (or acetonitrile) in buffer. Although selectivity can differ between modifiers, it is generally recommended to change column type if no separation is observed over the range of $0.5 < k' < 20$. Separations are generally improved at subambient temperature. A

TABLE 3 Chiral Separation Mechanisms, Analyte Requirements, and Modes of Operation for Different Chiral Stationary-Phase Types

CSP type	Chiral separation mechanism	Analyte requirements	Mode of operation
Donor–acceptor (Pirkle) type: DNB-phenylglycine, DNB-leucine, naphthylalanine	H bonding, π – π interaction, dipole–dipole interaction	Ability to π - or H-bond; aromatic group helpful	Normal (usually) or reversed phase
Polymer-based carbohydrates: derivatized cellulose or amylose	Multiple interactions, including inclusion complexation and attractive interactions	Ability to H-bond; steric bulk near chiral center useful	Reversed and normal phases
Inclusion complexation type: cyclodextrins, crown ethers	Inclusion complexation, H bonding	Polar and aromatic groups	Reversed and normal phases
Protein based: albumin, glycoprotein	Hydrophobic and electrostatic interactions	Ionizable groups (amine or acids); aromatic group useful	Reversed phase

Source: Compiled from references 4 and 49.

primary advantage of this type of CSP is that if a chiral separation is observed, a stationary phase prepared with the opposite enantiomer can be selected to reverse elution order. It is, therefore, possible to elute the minor enantiomer before the primary enantiomer to facilitate quantitation.

Modern polysaccharide columns are based on cellulose or amylose derivatives coated onto silica. Chiral discrimination and applications have been extensively documented,^{50, 51} but the mechanism of chiral discrimination is not yet fully understood. Whereas numerous phases are available within this subset, orthogonality can generally be obtained from a set of three or four columns as a first approach to method development. A typical choice of columns would be to try a set of different amylase (Chiralpak AD and AS) and cellulose (Chiralcel OD or OJ) columns⁵² and defer more extensive method development to the subset of samples not separated by these columns. The columns specified are run in the normal-phase mode and, accordingly, mobile phases are typically mixtures of hexane with small amounts of isopropanol or ethanol to control retention. However, selectivity is changed by different polar modifiers. Tailing may be minimized by the addition of 10–50 mM trifluoroacetic acid (TFA) or triethylamine (TEA). Analogue of the columns specified (AD-R, AS-R, OD-R, and OD-J) are available for reversed-phase separation.

Inclusion complexation–based separations are typically performed on cyclodextrin-based columns. Cyclodextrins (CDs) consist of 6 (α), 7 (β), or 8 (γ) glucopyranose units connected by α -(1,4)-glycosidic linkages. Chiral recognition is based on the hydrophobic portion of a molecule entering the CD cavity and interaction (hydrogen bonding) of the polar portion of the molecule with the polar groups on the cavity opening. The choice of CD is dependent largely on the size of the nonpolar portion of the molecule. (For pharmaceuti-

cals, β -CD has shown the broadest applicability.) For varied chiral recognition, each type of CD can be derivatized to contain different polar constituents at the cavity opening. Separations can be performed in both the reversed-phase and the normal-phase modes or in 100% acetonitrile or methanol (polar organic mode), depending largely on the solubility of the analyte. In general, the best separation is obtained in the reversed-phase mode.⁴

Separations on protein stationary phases such as albumin, orosomucoid, ovomucoid, pepsin, and cellulase, covalently bonded to silica or polymeric supports, are performed using aqueous buffers with organic modifiers and, in this respect, are useful for polar pharmaceuticals. It should be noted, however, that the stability of the various packings is typically limited to operation within a fairly narrow pH range and that the percentage of organic is typically limited to 10–50%, depending on column type. The separation mechanism is complex, but is based on both hydrophobic and electrostatic interactions. Accordingly, changes in selectivity can be achieved by varying both the type of organic solvent added (the amount of organic solvent controls k' but generally has a lesser effect on selectivity) and the mobile-phase pH. Generally, method development may use a 10-mM phosphate buffer at pH 5–7 and sufficient isopropanol to achieve the desired k' range as a starting point.⁴ Subsequently, the pH is varied for enantioselectivity. However, the influence of pH is somewhat difficult to predict because both the charges of the analyte and the stationary phase are affected.

IV. THIN-LAYER CHROMATOGRAPHY

Modern TLC can be conducted in both the normal-phase and the reversed-phase formats and can be extended to the separation of chiral compounds by modifying the stationary phase or mobile phase with chiral selectors.⁵³ Using automated systems, performance equal to that achieved by HPLC is, in some cases, possible. Applications for quantitative analysis, including examples of stability-indicating and validated methods for pharmaceuticals, have been reviewed.⁵⁴

The role of TLC in qualitative or semiquantitative analysis is, however, large. TLC is a useful technique to complement HPLC during early-phase method development. A particular advantage of TLC is that it can be used in either reversed-phase or normal-phase mode with any sample solvent system and that all sample components loaded onto the plate can be visualized. In this capacity, reversed-phase TLC is a useful tool for evaluating mass balance issues that may arise during forced-degradation studies. For example, to verify that a loss in mass balance is not the result of irreversible adsorption on a packed column, the sample may be run using the same conditions on a TLC plate and the origin critically evaluated. A sample prepared for reversed-phase HPLC may be run using normal-phase TLC to verify that all related substances have been observed. Alternatively, two-dimensional chromatography in which the plate is first developed in one solvent system and then in a perpendicular direction using a different solvent system can be useful to ascertain that peak purity is obtained in the first dimension.

To facilitate identification of separated bands, TLC/MS may be used.⁵⁵ This approach may be as simple as removal of the band from the plate, extraction of the solvent into an appropriate solvent, and injection into the ion source of the MS. However, other approaches such as fast atom bombardment (FAB) and matrix- or surface-assisted laser desorption/ionization have also been used.

V. GAS CHROMATOGRAPHY

The improved mass transfer kinetics in gases as opposed to liquids make gas chromatography (GC), particularly in the capillary format, a faster, higher resolution technique than liquid chromatography. However, gas chromatography is limited to applications of volatile, thermally stable compounds⁵ and precautions must be taken to ensure that samples are prepared to prevent non-volatile components from entering the system. For drug substances and drug products not constrained by these criteria, GC may be used as a supportive (orthogonal) method or for stability and release methods. For example, Mielcarek *et al.*⁵⁶ have used GC/MS for the determination of photodegradation products of Nilvapine (a calcium channel blocker) and Cyr *et al.*⁵⁷ have used GC for the determination of doxepin isomers and related compounds in both drug substances and capsules.

An additional broad area of utilization of GC is the determination of residual solvents (organic volatile impurities). The solvents allowed for use in the synthesis and manufacture and their respective residual limits have been addressed by the ICH.⁵⁸ Tests for residual solvents should be conducted whenever production or purification processes may result in the presence of such solvents. This mandates that residual solvents be determined in drug substances. For drug products, residual solvent levels may be calculated from the levels in the ingredients used to produce the drug product unless class 1 (to be avoided) or class 2 (to be limited) solvents are used in the manufacture of the drug substance, excipients, or drug product.³

The primary challenge in the GC analysis of residual solvents is in ensuring that nonvolatile components of the sample are not introduced into the GC. This is typically achieved by headspace sampling, although other techniques such as solid-phase microextraction (SPME) are being investigated.⁵⁹ Typically, analyses are performed using temperature-programmed capillary GC with thick-film coatings to retain the volatile compounds. Identification of individual components can be performed by using two different columns in parallel or by using MS detection. Care should be taken to ensure that only the expected solvents are present because relatively nonvolatile solvent impurities may become concentrated and solvent reactions can occur during the production process. Acetone, for example, can form mesityl oxide and mesitylene, and ethanol can form diethyl ether.⁶⁰

Headspace sampling for organic volatile impurities (OVIs) is typically performed by dissolving the drug substance in a suitable solvent, rather than on the drug in the solid phase to prevent matrix-trapping effects. Subsequently, a specified volume of solution is added to a headspace vial and the solution is heated for a specified time at a specified temperature. Samples of the headspace

are transferred to the GC by pressurizing the vial to vent the headspace to a heated sample loop. The loop is then switched via a valve to bring the sample into the carrier gas stream and into the GC.

De Smet *et al.*⁶¹ have published a generic method for OVI in drug substance based on headspace analysis. In this approach, 100 mg of drug substance is dissolved in 2 ml 1,3-dimethyl-2-imidazolidinone (DMI), which has been shown to provide excellent dissolution properties for a wide range of sample types. The sample is introduced onto two columns by using a double-hole ferrule for the injector-to-column connection. A 50 m × 0.32 mm i.d. column coated with 5 μm chemically bonded polydimethylsiloxane is used for separation and quantitation. A 50 m × 0.32 mm i.d. column coated with 1.2 μm chemically bonded polyethylene glycol is used for confirmatory identification. The method was validated for the same run determination of 23 OVIs in the concentration range of 50–100 to 2500 ppm.

A chief advantage of the procedure outlined is that the method can be used for multiple drug substances, provided that the OVIs used are included in the 23-component set. Moreover, for use with different drug substances, the only validation criterion is to verify that the drug substance does not alter the distribution coefficients between the solvent and headspace. For samples that are insoluble in DMI, other solvents such as *N,N*-dimethylacetamide or *N,N*-dimethylformamide (DMF) may be used. Alternatively, DMI may be modified with water. The use of water can promote the distribution of OVIs into the headspace, but can have deleterious effects on the GC column. As a change in the sample solvent will influence the distribution of the solvent and the headspace, more extensive validation is required when the solvent system is changed.

Although the preceding discussion is focused primarily on the analysis of OVIs in drug substance headspace, GC may also be extended to OVIs in products, provided that the criterion of extracting the solvents from the matrix is achieved. Kumar and Egoille⁶² have used headspace GC for the determination of isopropanol and toluene in an estrogen and progesterone transdermal patch. Samples were prepared for headspace analysis by extraction in DMF overnight and were quantitated using the standard addition method to eliminate any concerns due to matrix effects. Recoveries for different levels of isopropanol and toluene varied from 90–106% with typical % RSDs from 2.1–8.6% ($n = 4$ at each level).

VI. SUPERCRITICAL-FLUID CHROMATOGRAPHY

Supercritical-fluid chromatography (SFC) was extensively evaluated in the late 1980s, in both the capillary and the packed-column formats, for a variety of compounds, including pharmaceuticals—primarily with negative results.⁶³ Subsequent evaluation of SFC has shown that the primary source of this disillusionment is that supercritical carbon dioxide is substantially less polar than initially predicted. In its simplest form, supercritical carbon dioxide can be thought of as providing approximately the same polarity as hexane. As a

result, SFC cannot be used as easily as reversed-phase HPLC for the analysis of polar compounds in polar matrices (such as many drug products) and does not currently compete with reversed-phase HPLC for these applications.

If the polarity is considered equivalent to hexane and polar modifiers are added to the supercritical fluid, then the separation may be considered similar to normal-phase HPLC. However, the viscosity and mass transfer properties of supercritical fluids are more favorable and can lead to increased separation efficiencies and decreased analysis times. Berger and Wilson,⁶⁴ for example, have demonstrated that separations with up to 260,000 theoretical plates can be achieved by serially coupling 10 HPLC columns without the deleterious pressure effects that would be encountered in separations using a liquid mobile phase. For applications that are not limited by polar matrices, SFC is, therefore, a viable option.

Systematic method development guidelines akin to those available for HPLC have not been developed. However, details beyond the scope of this chapter are available.⁶⁵ Separation conditions should be evaluated based on the polarity of the solute and the polarity of the stationary phase.⁶⁶ Stationary-phase polarity increases in the order C18<C8<phenyl<cyano<silica<amine<diol. For nonpolar solutes on nonpolar stationary phases, separation may be achieved using pure carbon dioxide. As solute or stationary-phase polarity increases, carbon dioxide modified with methanol (or isopropanol, ethanol, or acetonitrile) or carbon dioxide modified with solvent and an additive such as TFA, acetic acid, triethylamine, or isopropylamine (0.5% or less) is required.

As in HPLC, it is possible to run gradients using SFC to facilitate method development. Common practice is to set the outlet pressure at 150–250 bar and column temperature at 30–80 °C and then to gradually increase the percentage of solvent and (where applicable) amount of additive to elute the compounds of interest. Following such initial scouting runs, isocratic conditions may be set, although gradient SFC has the general advantage over gradient HPLC of more rapid reequilibration times.

The capillary format of SFC is attractive because of the potential of interfacing with a wide array of detectors available when carbon dioxide is used as the mobile phase. Several advances, beyond the issue of mobile-phase polarity, are, however, required prior to the technique becoming viable for pharmaceutical analyses. Capillary SFC instrumentation has lacked the requisite analytical performance for pharmaceutical analyses, and difficulties are encountered due to the acidic nature of fused silica and the problem of measuring impurities while, at the same time, not overloading the stationary phase with the main component.⁶⁷

Gyllenhaal and Vessman⁶⁷ have used packed-column SFC for the analysis of metoprolol (a β -adrenoreceptor-blocking agent). The drug was separated from 12 analogue and related compounds in less than 12 min. The method used conditions similar to those discussed previously. Specifically, a 125 \times 4 mm (5 μ m) diol column was used with carbon dioxide modified with 10% (v/v) methanol containing 0.35 M acetic acid and 0.07 M triethylamine at a flow rate of 2 ml/min. Back pressure was set at 150 bar, oven temperature was 40 °C, and detection was by UV at 273 nm. It was noted that the use of trimethylamine curtails tailing of basic compounds, but also degrades the

silica-based stationary phase. The addition of acid in a stoichiometric excess promotes column stability while, at the same time, not adversely affecting the function of the base.⁶⁷

Results of the study indicate that it is possible to simultaneously detect the active drug substance and most related substances at 0.1% (w/w). Furthermore, the method provides different selectivity than reversed-phase HPLC. As a broader conclusion, this indicates orthogonality to reversed-phase HPLC and suggests the viability of SFC in support of early-phase method development.

In another published application, Strode *et al.*⁶⁸ developed a methodology for separation of lovastatin (a hypocholesterolaemic drug) from its degradation products. Most notable from this separation was the ability to introduce 5 μ l of tablet extracted into 80/20 v/v acetonitrile/water into a separation system consisting of a silica column (250 \times 4.6 mm, 3 μ m) with 6/94 (v/v) methanol with 0.5% TFA/carbon dioxide at 2 ml/min, a back pressure of 230 bar, and a temperature of 45 °C. The compatibility of SFC with partially aqueous sample solvents potentially extends the applicability to additional sample types, although more comprehensive studies are required to fully clarify the extent of compatibility and limitations in SFC operating conditions with aqueous samples.

To a larger degree than separations of drugs and related substances, packed-column SFC has generated considerable interest for use in enantiomeric separations.⁶⁹ SFC has shown compatibility with a large variety of chiral stationary phases, including cyclodextrins (native and derivatized), Pirkle type, and derivatives of cellulose and amylose. The chief advantage potentially is the improved separation efficiency, which increases of the enantiomers but also reduces the likelihood that impurities will interfere with the analysis.

Because of the polarity of most chiral stationary phases, most separations require at least binary fluids (methanol in carbon dioxide) to effect the separation and more typically also an additive as described previously. Separations using various Chiralcel and Chiralpak columns have been carried out at Berger Instruments.⁷⁰ Numerous enantiomers were separated on Chiralcel columns using carbon dioxide with methanol containing 0.5% isopropylamine. Without isopropylamine, the peaks tail badly. An illustration of the applicability is shown in Figure 7. The enantiomeric excess of propanolol [(*s*)-(–)-isomer with β -adrenergic-blocking activity] may be determined in less than 4 min. Furthermore, studies on linearity and reproducibility indicate that the responses for *R*-propanolol and *S*-propanolol are linear from 0.25–250 ppm and 2.5–2500 ppm, respectively, with acceptable reproducibility across the range. This dynamic range indicates that it should be possible to observe the impurity enantiomer at well below required levels.

To address development of chiral separations by SFC, Villeneuve and Anderegg⁷¹ have developed an SFC system using automated modifier and column selection valves. Columns (250 \times 4.6 mm i.d., 10 μ m) packed with Chiralpak AD, Chiralpak AS amylose derivative, Chiralcel OD cellulose carbamate derivative, and Chiralcel OJ cellulose ester derivative (Chiral Technologies, Exton, PA) were connected to a column-switching valve. Candidate samples were run successively on each column using fixed isocratic, isobaric, and isothermal conditions of 2 ml/min, 205 atm pressure, and 40 °C with the vari-

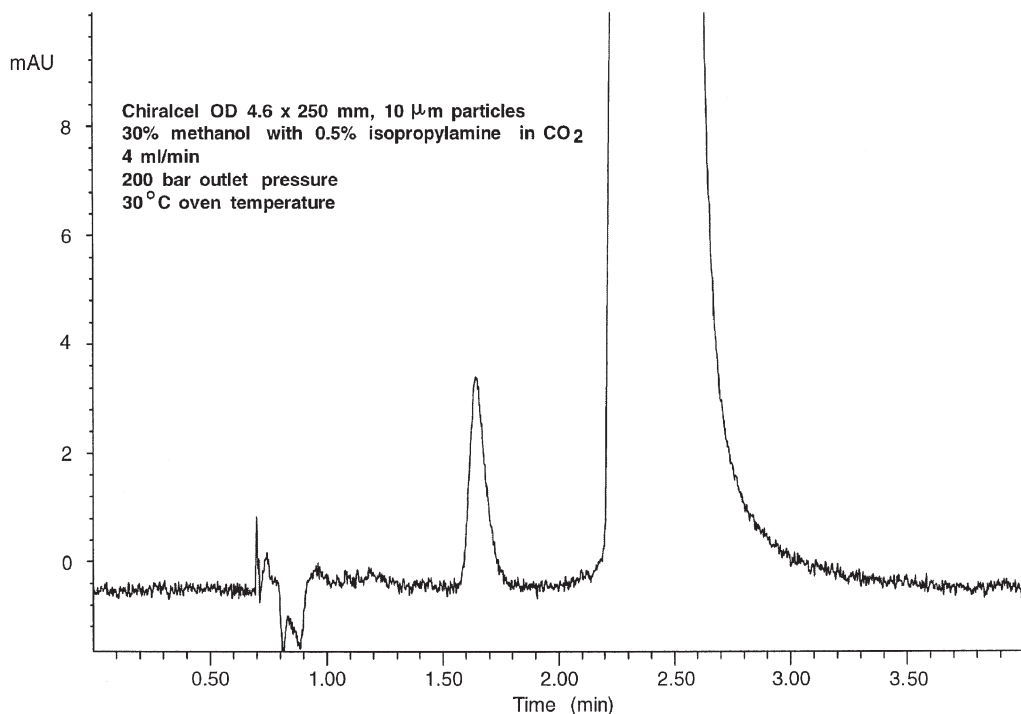

FIGURE 7 Enantiomeric excess of propanolol by packed-column SFC. Conditions are shown in the inset. Reprinted with permission from *SFC as the Method of Choice for Chiral Separations of Molecules Soluble in Organic Solvents*. Berger Instruments, Newark, DE.

able run-to-run being the percentage of polar modifier (methanol, ethanol, or isopropanol) with and without 0.1% TEA or TFA. Samples were dissolved in methanol at 1 mg/ml and injected as 10- μ l aliquots. Each analysis was selected to be 25 min long with a 20-min equilibration time between runs. Notably, following the automated run of the array conditions, only minor modification in operation conditions was necessary to optimize the separations. No common theme was noted for better, nonempirical prediction of which conditions are most suitable based on compound structure. Although efforts continue to develop predictive models for the selection of operating conditions, true *a priori* predictive models have been elusive.⁷²

VII. CAPILLARY ELECTROPHORESIS

In their simplest form, capillary electrophoretic separations are based on differences in the charge-to-size ratios of the analytes. The initial consideration for CE is, therefore, to find conditions under which ionization of the analytes is achieved. As noted by Altria,⁷³ for acids or bases, ionization can typically be achieved under one of two sets of conditions: in phosphate buffer (pH 2.5) for bases or in borate buffer (natural pH 9.3) for acids. Use of these two sets of conditions provides a generic approach to method development and has been shown to be viable for a wide range of sample types. For pharma-

ceutical applications, the simultaneous determination of the API and related substances is typically achieved by introducing relatively high concentrations of samples (0.2–0.5 mg/ml) and by using low-wavelength UV detection (200 nm). Quantitative reproducibility is improved by use of an internal standard.

For nonionized compounds, or to change selectivity for ionized compounds, buffer additives such as micellar sodium dodecyl sulfate (SDS) or an octane/ butan-1-ol/SDS microemulsion may be used.⁷⁴ For nonionic compounds, separation is based on distribution between the buffer and the charged additive, which moves at a different velocity than the background electrolyte. For charged species, separation is based on both the partitioning and the electrophoretic mobility of the sample components. Samples that are not soluble in aqueous media may be separated in organic solvents such as methanol or acetonitrile containing a conductive salt.⁷⁴

Examples of CE separations in each of these modes have appeared in the literature. Chen *et al.*,⁷⁵ for example, have used free-solution capillary electrophoresis for the development and validation of a method for Protegrin IB-367, a polycationic peptide with a wide range of antimicrobial activities. Separation was achieved using 100 mM sodium phosphate pH 2.6, UV detection at 200 nm, a capillary temperature of 25 °C, a 45 cm (effective length) \times 50- μ m fused-silica (underivatized) capillary, and a 20-kV operating voltage. α -Amino glycyphenylalanine amide was used as an internal standard. Validation of the method showed performance met preestablished criteria with respect to accuracy, precision, linearity, range, limit of detection, limit of quantitation, specificity, and system suitability. Based on an API concentration of 0.5 mg/ml, the limit of detection for impurities was 0.1%. Robustness was demonstrated by evaluating relative migration times and resolution between IB-367 and three related substances versus changes in buffer strength, pH, separation voltage, and capillary temperature.

Farina *et al.*⁷⁶ have used both CE and HPLC for the determination of Ceftazidime (cephalosporin antibiotic) and its degradation products. The CE separation was performed using a micellar media. Specifically, separation was achieved using a 64.5-cm (56-cm effective length) \times 50- μ m fused-silica capillary with extended light path, a buffer consisting of 25 mM sodium borate, pH 9.2 (unadjusted) with 150 mM SDS, an applied voltage of 20 kV, and a capillary temperature of 25 °C. Detection was by UV at 254 nm. Both the HPLC and the CE methods separated the API from the related substances and provided consistent quantitative results. Comparing CE and HPLC, it was noted that CE procedures are faster but that reproducibility of CE is often not as good as that of HPLC. An important attribute to using both HPLC and CE is the increased likelihood of detecting unknown impurities.

Cherkaoui and Veuthey⁷⁷ have used nonaqueous CE for the simultaneous separation of nine nonsteroidal anti-inflammatory drugs. Separation was achieved using methanol/acetonitrile (40/60 v/v) with 20 mM ammonium acetate. Perhaps more important, the elution order of the individual components was shown to change with both solvent and electrolyte composition, indicating that selectivity can be manipulated.

Numerous chiral discrimination agents have also been investigated for CE, including natural and derivatized cyclodextrins (both charged and uncharged),

carbohydrates, proteins, antibiotics, natural and synthetic surfactants, and crown ethers.⁷⁴ Considerable interest has been shown in the use of cyclodextrins (CDs), in particular to generate a systematic approach to method development using CDs. Potentially, achiral methods can be developed first using buffers/modifiers that provide acceptable peak shape and analysis time. Subsequently, different types and concentrations of cyclodextrins can be added to develop chiral separation.⁷⁴ Such an approach is extremely appealing because methods initially developed for impurity profiling and/or as stability-indicating assays can potentially be extended to chiral purity testing with minimal additional method development.

The use of cyclodextrins as chiral selectors in CE has recently been reviewed⁷⁸ and the influence of various separation parameters discussed. Separation is influenced by the type and concentration of CD, pH, buffer composition, capillary temperature, and separation voltage. As noted, an approach to method development is to choose conditions that allow for solute ionization and then to choose the CD type based on the solute structure. As noted in Section III.F, native α -, β -, and γ -cyclodextrins have different cavity sizes and will be applicable to different compounds. (Generally, β -CD is the most applicable to pharmaceuticals.) CDs may also be methylated, hydroxyethylated, etc. to further change selectivity. If chiral discrimination is observed with a given CD, the concentration of CD is important to obtain the desired distribution coefficients between the CD and the buffer. From published separations, the CD concentration is typically in the range of 5–50 mM. Solubility constraints may necessitate the addition of organic solvent to some CDs to achieve this range. For neutral compounds, charged CDs (methylamino, sulfobutylether, sulfate, etc. derivatives) can be used.

Although the foregoing discussion indicates that there are numerous possibilities available in the development of CD-based CE, it is extremely attractive to develop a systematic approach to method development, much as discussed for reversed-phase HPLC. To address this issue, Liu and Nussbaum⁷⁹ have published a systematic screening approach based on six runs for the separations of small, amine-containing enantiomers. In this approach, samples are run using fused-silica capillaries at 20 °C, with the following buffer systems/conditions (detection is at 214 nm):

- (i) 30 mM phosphoric acid adjusted to pH 2.5 with tetrabutylammonium hydroxide (TBA); this is used as a control
- (ii) 15 mM dimethyl- β -CD/30 mM phosphate/TBA pH 2.5
- (iii) 30 mM hydroxypropyl- β -CD/30 mM phosphate/TBA pH 2.5
- (iv) 30 mM hydroxypropyl- α -CD/30 mM phosphate/TBA pH 2.5
- (v) 30 mM hydroxypropyl- γ -CD/30 mM phosphate/TBA pH 2.5
- (vi) 32 mM sulfated- β -CD/25 mM phosphoric acid adjusted to pH 2.5 with triethylamine

Items (i)–(v) are run using a 50- μ m \times 57-cm capillary at 30 kV with normal polarity. Item (vi) is run using a 25- μ m \times 27-cm capillary at 12 kV (reversed polarity).

As outlined,⁷⁹ 39 pairs of enantiomers used to develop the approach were separated either partially or completely. Applying the approach to 10

compounds not used to develop the screening process, 8/10 were separated and 5/10 were nearly baseline separated. It is notable that, following screening, additional optimization may be possible using the considerations outlined previously.

In addition to publications detailing criteria for method development, numerous examples of the use of CD-based CE have appeared in the literature. To illustrate method performance, a paper by Zhou *et al.*⁸⁰ details the development and validation of methodology for the determination of enantiomeric purity of the compound shown in Figure 8a. An optimized separation (Fig. 8b) was obtained using 1.5% (w/w) sulfated- β -CD in pH 2.5 sodium phosphate buffer (25 mM), a 63-cm (56 cm effective length) \times 75- μ m capillary, detection at 200 nm, a temperature of 30 °C, and an electric field strength of -15 kV. Sample solutions of 0.5 mg/ml in 90/10 (v/v) water/acetonitrile were introduced using hydrodynamic injection at 50 mbar for 3 s.

As part of the validation study, the lot-to-lot variability of sulfated- β -CD was evaluated by comparing the migration times of both enantiomers using three lots of material. The % RSD was less than 1.5%, based on eight injections. Furthermore, the method was run by different operators, on different days and with different instruments, with capillaries from different lots. Migration times were within 1 min for both enantiomers under all conditions, which is superior to the performance observed for most chiral HPLC analyses. The method was determined to be linear from 0.1–125% of target. The

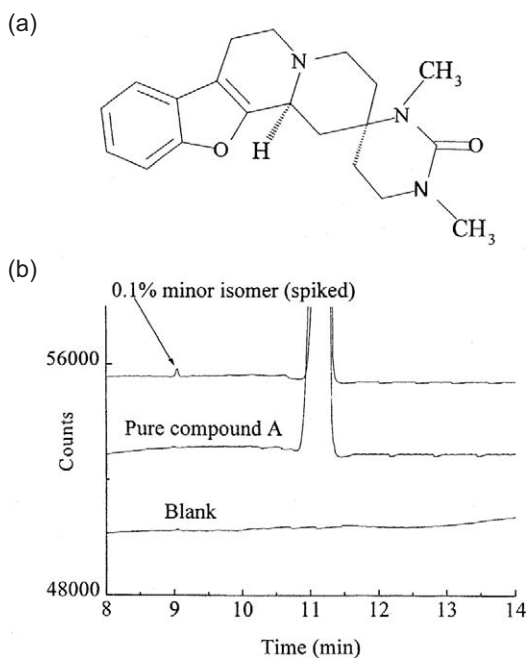

FIGURE 8 Molecular structure of a chiral pharmaceutical (a) and chiral separation by CE for the determination of enantiomeric purity (b). Conditions are specified in the text. Reprinted with permission from Zhou, L., Johnson, B. D., Miller, C., and Wyratt, J. M. *J. Chromatogr., A* 875:389, 2000.

limits of quantitation and detection were determined to be 0.3% and 0.1%, respectively. Accuracy, as determined by the average recovery of the minor enantiomer at 0.1, 0.5, and 1.0%, was shown to be 102.3%. Precision, as measured from the RSD of area% for six replicate injections of 0.5 mg/ml sample spiked with 0.5% of the minor isomer, was 0.01% for the major isomer and 3.3% for the minor isomer.

VIII. CONCLUSIONS

The examples of methods presented herein demonstrate that chemical separation techniques can be developed to support all phases of drug development and can readily meet ICH guideline expectations for performance. Development of methods to achieve the final goal of ensuring the quality of drug substances and drug products is nevertheless not a trivial undertaking. Although systematic and generic guidelines for the development of methods are available, these must be implemented in conjunction with an understanding of the chemical behavior and physicochemical properties of the drug substance and dosage form.

Progress continues to be made both in instrumentation and in the understanding of the mechanisms of chemical separations, and it is likely that these advances will further streamline the method development process. However, it is unlikely that a single generic approach can be developed that will be suitable for the development of a methodology for all pharmaceuticals.

IX. SUMMARY

Analytical methods are required to characterize drug substance and drug product composition during all phases of pharmaceutical development. Early-phase methods must support changes in synthetic routes and dosage form and elucidate the structures and levels of impurities. In later phases, goals change to the development of rapid and robust methods for release and stability evaluation that can be transferred to quality units. Accordingly, method development should be viewed as an iterative process.

All phases of analytical development are ideally supported by chemical separation techniques such as HPLC, TLC, GC, SFC, and CE. HPLC continues to be the primary method of analysis throughout the pharmaceutical development process. Although HPLC is limited in its ability to separate more than 15–20 components in a single analysis, and variations in columns and instrumentation manufacturer to manufacturer complicate transfer of methods, HPLC can readily be implemented to meet ICH requirements for method performance. For early-phase methods, HPLC can be coupled dynamically to mass and nuclear magnetic resonance spectrometers to facilitate the identification of unknown impurities. In later phases, HPLC can be implemented in a fully automated format as a high-throughput method for release and stability testing.

Whereas the other separation methods have been demonstrated to also provide the requisite performance for release and stability testing for select drug substances and drug products, more typically the techniques are applied as supportive methods for HPLC during early-phase development and in niche areas during late-phase development. Because each separation method provides a different mechanism of separation to HPLC, utilization in early-phase development can be used to confirm specificity of HPLC methods. In later phases, both SFC and CE have shown applicability to chiral separations, and GC remains as the unique technique for the determination of residual solvents.

Despite the broad-based utility of separation methods, *a priori* prediction of operating conditions for the separation of a given API and its impurities has remained elusive. However, systematic approaches, or the use of generic conditions, can be exploited in method development. This chapter has endeavoured to summarize these approaches within the context of the goals that a method should achieve in the various stages of pharmaceutical development.

REFERENCES

1. Specifications: Test procedures and acceptance criteria for new drug substances and new drug products: Chemical substances. ICH Guideline Q6A.*
2. United States Pharmacopeia and National Formulary USP 24/NF 19. National Publishing, Philadelphia, 1999.
3. Miller, J. M. and Crowther, J. B., Eds. *Analytical Chemistry in a GMP Environment*. Wiley, New York, 2000.
4. Snyder, L. R., Kirkland, J. J., and Glajch, J. L. *Practical HPLC Method Development*, 2nd ed. Wiley, New York, 1997.
5. McNair, H. M. and Miller, J. M. *Basic Gas Chromatography*. Wiley, New York, 1998.
6. Giddings, J. C. *Dynamics of Chromatography*, Part 1. Dekker, New York, 1965.
7. Impurities in new drug substances. ICH Guideline Q3A.*
8. Impurities in new drug products. ICH Guideline Q3B.*
9. Text on validation of analytical procedures. ICH Guideline Q2A.*
10. Validation of analytical procedures: Methodology. ICH Guideline Q2B.*
11. *Pharm. Cosmetic Qual.* December:1, 1997.
12. Majors, R. E. *LC-GC Int.* April:8, 1998.
13. Dolan, J. W., Snyder, L. R., Djordjevic, N. M., Hill, D. W., and Waeghe, T. J. *J. Chromatogr., A* 857:1, 1999.
14. Dolan, J. W., Snyder, L. R., Djordjevic, N. M., Hill, D. W., and Waeghe, T. J. *J. Chromatogr., A* 857:21, 1999.
15. *Solvent Guide* (R. S. Higgins and S. A. Klinger, Eds.). Burdick & Jackson, Muskegon, MI, 1990.
16. Gilpin, R. K. and Pachla, L. A. *Anal. Chem.* 71:217R, 1999.
17. Vervoort, R. J. M., Debets, A. J. J., Claessens, H. A., Cramers, C. A., and De Jong, G. J. *J. Chromatogr.* 897:1, 2000.
18. Catalano, T., Madsen, G., and Demarest, C. *Am. Pharm. Rev.* 3:62, 2000.
19. Kirkland, J. J., Martosella, J. D., Henderson, J. W., Dilks, C. H., Jr., and Adams, J. B. *Am. Lab.* 31:22, 1999.
20. Neue, U. D., Walter, T. H., Alden, B. A., Jiang, Z., Fisk, R. P., Cook, J. T., Glose, K. H., Carmody, J. L., Grassi, J. M., Cheng, Y., Lu, Z., and Crowley, R. J. *Am. Lab.* 31:36, 1999.
21. Gardner, M. S., Voyksner, R. D., and Haney, C. A. *Anal. Chem.* 72:4659, 2000.
22. Stability testing of new drug substances and products. ICH Guideline Q1A.*
23. Singh, S. and Bakshi, M. *Pharm. Technol. On-Line* April:1, 2000. www.pharmportal.com.
24. Letter, W. S. *LC-GC* 15:508, 1997.

*ICH guidelines can be obtained at <http://www.ifpma.org/ich5q.html>.

25. Stability testing: Photostability testing of new drug substances and products. ICH Guideline Q1B.*
26. Niessen, W. M. A. and Tinke, A. P. *J. Chromatogr.*, A 703:37, 1995.
27. Niessen, W. M. A. *J. Chromatogr.* 856:179, 1999.
28. Albert, K. *J. Chromatogr.*, A 856:199, 1999.
29. Thomasberger, A., Engel, F., and Feige, K. *J. Chromatogr.*, A 854:13, 1999.
30. Zhao, Z., Wang, Q., Tsai, E. W., Qin, X.-Z., and Ip, D. *J. Pharm. Biomed. Anal.* 20:129, 1999.
31. Peng, S. X., Borah, B., Dobson, R. L. M., Liu, Y. D., and Pikul, S. *J. Pharm. Biomed. Anal.* 20:75, 1999.
32. Guichon, G. *J. Chromatogr.*, A 852:603, 1999.
33. Neue, U. D., Alden, B. A., and Walter, T. H. *J. Chromatogr.*, A 849:101, 1999.
34. Snyder, L. R. and Dolan, J. W. *J. Chromatogr.* 892:107, 2000.
35. Snyder, L. R. and Dolan, J. W. *J. Chromatogr.*, A 721:3, 1996.
36. Lewis, J. A., Snyder, L. R., and Dolan, J. W. *J. Chromatogr.* 721:15, 1996.
37. <http://www.lcresources.com/dlmd.htm>.
38. Paino, T. C. and Moore, A. D. *Pharm. Technol.* October:86, 1999.
39. Vial, J. and Jardy, A. *Anal. Chem.* 71:2672, 1999.
40. Vial, J. and Jardy, A. *J. High Resolut. Chromatogr.* 22:217, 1999.
41. Walsh, A., Smith, S., Stanley, J., Gostick, J., Steidinger, D., Rogers, P., Sutcliffe, M., Rowell, I., Jones, B., Claydon, J., Mehmood, A., Brown, R., Hodge, A., Price, H., Warren, T., Holland, S., Dowbakin, J., Shephard, T., and Boughey, A. *Pharm. Technol.* March:134, 2000.
42. Vander Heyden, Y., Jimidar, M., Hund, E., Niemeijer, N., Peeters, R., Smeyers-Verbeke, J., Massart, D. L., and Hoogmartens, J. *J. Chromatogr.*, A 845:145, 1999.
43. Kele, M. and Guiochon, G. *J. Chromatogr.*, A 830:41, 1999.
44. Kele, M. and Guiochon, G. *J. Chromatogr.*, A 830:55, 1999.
45. Kele, M. and Guiochon, G. *J. Chromatogr.*, A 855:423, 1999.
46. Kele, M. and Guiochon, G. *J. Chromatogr.*, A 869:181, 2000.
47. Vasselle, B., Gousser, G., and Bounine, J.-P. *J. Pharm. Biomed. Anal.* 19:641, 1999.
48. Shamrock, W. F., Reilly, K., and Lloyd, D. K. *J. Pharm. Biomed. Anal.* 21:1225, 2000.
49. *Chiral Separations: Applications and Technology* (S. Ahuja, Ed.). Am. Chem. Soc., Washington, DC, 1997.
50. Okamoto, Y. and Yashima, E. *Angew. Chem., Int. Ed. Engl.* 37:1020, 1998.
51. Yashima, E. and Okamoto, Y. *Bull. Chem. Soc. Jpn.* 68:3289, 1995.
52. Wang, T. and Chen, Y. W. *J. Chromatogr.* 855:411, 1999.
53. Poole, C. F. *J. Chromatogr.*, A 856:399, 1999.
54. Sherma, J. *Anal. Chem.* 72:9, 2000.
55. Wilson, I. D. *J. Chromatogr.*, A 856:429, 1999.
56. Mielcarek, J., Stobiecki, M., and Franski, R. *J. Pharm. Biomed. Anal.* 24:71, 2000.
57. Cyr, T. D., Lawrence, R. C., and Lovering, E. G. *J. AOAC Int.* 75:804, 1992.
58. Impurities: Guideline for residual solvents. ICH Guideline Q3C.*
59. Camarasu, C. C. *J. Pharm. Biomed. Anal.* 23:197, 2000.
60. Krstulovic, A. M. and Lee, C. R. *J. Chromatogr.*, B 689:137, 1997.
61. De Smet, M., Roels, K., Vanhoof, L., and Lauwers, W. *Pharm. Forum* 21:501, 1995.
62. Kumar, N. and Egoille, J. C. *J. Chromatogr.*, A 859:113, 1999.
63. Smith, R. M. *J. Chromatogr.*, A 856:83, 1999.
64. Berger, T. A. and Wilson, W. H. *Anal. Chem.* 65:1451, 1993.
65. *Supercritical Fluid Chromatography with Packed Columns* (K. Anton and C. Berger, Eds.). *Chromatographic Science Series*, Vol. 75. Dekker, New York, 1998.
66. *Packed Column SFC in the Pharmaceutical Industry*. Berger Instruments, Newark, DE.
67. Gyllenhaal, O. and Vessman, J. *J. Chromatogr.*, A 839:141, 1999.
68. Strode, J. T. B., Taylor, L. T., Howard, A. L., and Ip, D. *J. Pharm. Biomed. Anal.* 20:137, 1999.
69. Phinney, K. W. *Anal. Chem.* 72:204, 2000.
70. *SFC as the Method of Choice for Chiral Separations of Molecules Soluble in Organic Solvents*. Berger Instruments, Newark, DE.
71. Villeneuve, M. S. and Anderegg, R. J. *J. Chromatogr.*, A 826:217, 1998.

72. Blackwell, J. A., Stringham, R. W., Xiang, D., and Waltermire, R. E. *J. Chromatogr., A* 852:383, 1999.
73. Altria, K. D. *LC-GC* 18:33, 2000.
74. Altria, K. D. *J. Chromatogr., A* 856:443, 1999.
75. Chen, J., Fausnaugh-Pollitt, J., and Gu, L. *J. Chromatogr., A* 853:197, 1999.
76. Farina, A., Porra, R., Cotichini, V., and Doldo, A. *J. Pharm. Biomed. Anal.* 20:521, 1999.
77. Cherkaoui, S. and Veuthey, J.-L. *J. Chromatogr.* 874:121, 2000.
78. Fanali, S. *J. Chromatogr., A* 875:89, 2000.
79. Liu, L. and Nussbaum, M. A. *J. Pharm. Biomed. Anal.* 19:679, 1999.
80. Zhou, L., Johnson, B. D., Miller, C., and Wyvratt, J. M. *J. Chromatogr., A* 875:389, 2000.

SETTING UP SPECIFICATIONS

IAN E. DAVIDSON

Aventis Pharmaceuticals, Bridgewater, New Jersey 08807

- I. INTRODUCTION
 - A. Definition of Specifications
 - B. Stages of Drug Development
- II. SETTING SPECIFICATIONS AT DIFFERENT STAGES OF DRUG DEVELOPMENT
 - A. Preclinical Studies
 - B. Investigational New Drug/Clinical Trial Application Stage
 - C. Phase II and Phase III Studies
 - D. New Drug Application/Marketing Authorization Application Stage
- III. INTERNATIONAL CONFERENCE ON HARMONIZATION GUIDELINES
 - A. Background to the International Conference on Harmonization
 - B. Guideline Q6A—Specifications for New Drug Substances and Products: Chemical Substances
 - C. Guideline Q6B—Specifications: Test Procedures and Acceptance Criteria for Biotechnological/Biological Products
 - D. Other Quality Guidelines Relevant to Setting Specifications
- IV. PHARMACOPEIAS AND SPECIFICATIONS
- V. STATISTICAL CONSIDERATIONS IN SETTING SPECIFICATIONS
- VI. SUMMARY
- REFERENCES

I. INTRODUCTION

A. Definition of Specifications

A good definition is found in the International Conference on Harmonization (ICH) guidelines on specifications^{1, 2}:

A specification is defined as a list of tests, references to analytical procedures, and appropriate acceptance criteria which are numerical limits, ranges or other criteria for the tests described. It establishes the set of criteria to which a drug substance, drug product or materials at other stages of manufacture should conform to be considered acceptable for their intended use. “Conformance to specification” means that the drug substance and drug product, when tested according to the listed analytical procedures, will meet the acceptance criteria. Specifications are critical quality standards that are proposed and justified by the manufacturer and approved by regulatory authorities as conditions of approval.

Much more information is provided on these guidelines in Sections III.B and III.C.

The regulatory importance of specifications is highlighted in the Food and Drug Administration requirements for manufacturing information on drug products, which state³:

The chemistry, manufacturing and control section of an NDA should adequately describe the composition, manufacture and specifications of both the drug product and the corresponding drug substance.

The same principles apply to regulatory agency submissions worldwide.

Specifications are really the ultimate means of testing a material for conformity to those attributes that ensure that the material is suitable for its intended use. That material could be a drug substance, a synthesis starting material or intermediate, an excipient, or a finished pharmaceutical dosage form. In the preclinical area, the materials to be tested could include animal feedstuffs and dosing solutions or items such as radiolabeled drugs for pharmacokinetic and metabolism studies.

It must be stressed that quality cannot rely solely on final testing and conformance to specifications. Safety and efficacy must be built into a drug substance or product by a variety of means. These will include a well-designed process, high-quality manufacturing facilities, operating procedures that ensure good manufacturing practice, and personnel well versed in the correct procedures for product manufacture.

Documentation will be needed to ensure adherence to good manufacturing principles, and laboratory services will have to be of the highest caliber to ensure that testing done on a product or material yields meaningful and valid data. The final specification testing is therefore the last step in a very important chain of events that need to be constantly controlled and monitored.

B. Stages of Drug Development

There are generally three stages of drug research and development. Within the author's company, these are defined as

- Lead generation
- Lead optimization
- Product realization

Lead generation encompasses those basic discovery activities that create a new drug molecule and identify its pharmacological potential. The analytical chemistry involved at this stage is mostly concerned with identifying the qualitative structure of the molecule and measuring the purity of small bench-scale lots of the compound. Formal specifications are of little value at this stage.

Lead optimization undertakes studies to test the absorption, distribution, metabolism, and excretion behavior of the drug, as well as pharmacological investigations to test the concept of the potential therapeutic effect of the drug and to determine its toxicological profile. Analytical testing is performed on the drug, animal dosing vehicles, and early clinical formulations. Details of this type of testing are further described in Sections II.A and II.B.

Product realization generally includes the phase beyond which the concept of the drug's therapeutic activity has been determined and full development has started to take the drug through full clinical testing to the marketplace.

In terms of discussing specifications, the most convenient way is to break development during the lead optimization and product realization periods into the following four phases:

- Preclinical studies
- Testing in preparation for the first clinical investigational new drug (IND)/clinical trial application (CTA)
- Phase II and phase III clinical testing
- Preparation and submission of new drug application (NDA)/marketing authorization application (MAA)

II. SETTING SPECIFICATIONS AT DIFFERENT STAGES OF DRUG DEVELOPMENT

A. Preclinical Studies

I. Drug Substance

The quality attributes of drug materials are applied during all stages of development. For example, when initial preclinical pharmacology and toxicology tests are performed, a drug substance of defined quality is required. The drug should be neither too pure nor too contaminated, in order that correct pharmacological assessments can be made. It is also important that the drug's toxicological properties are tested using material containing its common synthesis impurities, including toxicological dosing vehicles such as solutions, suspensions, and animal feedstuffs.

Likewise, when metabolites are prepared for metabolism and pharmacokinetic studies, the purity needs to be defined for accuracy of data generation. Although formal specifications are not set at this stage, analytical testing is performed and judgments are made as to the suitability of the materials for their intended purpose.

A typical battery of tests for a drug substance at this stage of development is shown in Table 1. At this stage, it is likely that individual impurities will not have been identified and that final detailed characterization of the structure will be tentative. Drug substance characteristics such as crystal state and polymorphism will not be well understood, and stability data will be limited.

Formal specifications will not be available, but decisions will be made on the suitability of the drug for its intended purposes of preclinical testing by scientific evaluation. This would normally be performed by a team of synthetic chemists, analytical and physical chemists, toxicologists, and quality assurance personnel. Analytical chemistry at this stage will be focused on developing specific methods and attempting to characterize the nature of impurities. Accelerated stability testing at this stage will be performed to identify stability pathways resulting from thermal, photochemical, or oxidative degradation. Such information is essential to the future formal setting of specifications for both the parent molecule and the decomposition products.

TABLE I Battery of Tests at Preclinical Stage of Development

Test parameter	Typical test procedures
1. Identity	Infrared spectroscopy Melting point
2. Structural elucidation	Mass spectroscopy Nuclear magnetic resonance
3. Assay of active parent compound	Chromatographic procedure Titration
4. Related substances (impurities)	Chromatography (HPLC/GLC/TLC) ^a
5. Inorganic impurities	Residue on ignition Heavy metals
6. Residual solvents	GLC
7. Moisture content	Karl Fischer titration
8. pH in solution	pH measurement

^a HPLC, high-performance liquid chromatography; GLC, gas-liquid chromatography; TLC, thin-layer chromatography.

2. Preclinical Dosage Forms

For toxicology and early pharmacokinetic studies, it is necessary to dose relevant quantities of drug substance to various animal species such as mice, rats, rabbits, and primates. Typical dosing vehicles are solutions, suspensions, and feedstuffs into which the drug has been uniformly mixed. Preclinical studies fall under the regulatory requirements of good laboratory practice (GLP). One of the requirements pertaining to dosing vehicles is documentation giving evidence of (a) the drug content within the vehicle matrix and (b) the stability of the drug in the vehicle over the time course of the preclinical experiment. Knowledge of impurities is also required.

Typical test parameters for solutions and suspensions would include appearance, drug content, impurity levels, and pH. Although formal specifications are not usually applied, an analytical certificate will be provided that accurately describes the quality of the product administered. For animal feedstuffs, in addition to drug and impurity content, an important test parameter is uniformity of content throughout the mix. As for drug substance, in the absence of formal specifications, an evaluation of the suitability of the dosing product for its intended use is made by a similar team of relevant experts.

3. Impurities and Metabolites

a. Impurities

During preclinical development and particularly during toxicology testing, it is important to know, wherever possible, the structure and content of impurities in drug substances. At times, erroneous conclusions are drawn about the toxicity of a drug substance when the toxicological manifestations result from the impurity(ies) rather than from the drug substance itself. Although formal specifications for impurities are not required at this stage, it is required to have

information on the quantity and nature of impurities, including those deriving both from the synthesis process and from drug decomposition.

b. Metabolites

It is important to mention that metabolites will be needed to conduct pharmacokinetic (PK) studies, both in preclinical and in clinical development. These need to be of sufficient purity to allow accurate quantitative PK measurements. Again, formal specifications are not usually set, but an analytical certificate covering a number of parameters such as purity, structure, and related substances needs to be included.

B. Investigational New Drug/Clinical Trial Application Stage

1. Drug Substance

When a new chemical entity has developed to the point of showing good therapeutic potential and an acceptable toxicology profile, the drug will be considered for clinical studies. At that point, provisional specifications are usually generated for investigational new drug (IND, United States) and clinical trial application (CTA, Europe), prior to conducting phase I clinical studies.

At this stage, a typical specification for a synthetic small molecule without any unusual physical or chemical characteristics might include the information shown in Table 2. Of course, for less common molecules such as oils or more complex drugs such as peptides, proteins, and multicomponent fermentation products, more complex specifications will be needed. It must always be recognized, however, that, at this stage of development, specifications will be tentative and subject to change based on more extensive data, which will be developed later. For example, it is not usual at this stage to have a specification for the polymorphic forms of a drug substance. However, it may later become apparent that this property is critical to drug bioavailability and performance and needs to be controlled and specified.

2. Clinical Formulations

At this stage, clinical formulations are simple, such as drug-filled capsules or injectable products. As such, specifications will be largely based on the drug substance, because the study objectives are to examine drug tolerability, safety, and pharmacokinetics in small numbers of human subjects.

C. Phase II and Phase III Studies

After demonstrating tolerability and an acceptable pharmacokinetic profile in phase I studies, a drug will be tested in small numbers of patients in phase II studies. At this point, a number of batches of drug substance will have been produced and it will be possible to get an idea of the purity profile, that is, the number and quantity of each impurity in the drug compared to the content of the active moiety.

By the time a drug is in phase III clinical testing, the drug will have been in development for 2–5 years, extensive data will probably exist on the drug substance, and a final or close-to-final commercial formulation will be available.

TABLE 2 Information Contained in a Typical Specification for a Synthetic Small Molecule

Test	Analytical procedures	Acceptance criteria
Identity	Infrared spectroscopy Melting point	Conforms to standard Melting range
Structural elucidation	Nuclear magnetic resonance Mass spectroscopy	Conforms to standard
Assay (parent molecule)	HPLC/GLC Titration	97.0–102.0% 98.0–102.0%
Related substances (impurities)	HPLC/GLC	Total impurities less than 2.0% Single individual impurities less than 1.5% Known impurity X less than 1.0%
Inorganic impurities	Residue on ignition/ sulfated ash	Less than 500 ppm
Residual solvents	GLC	Solvent X less than 0.50% Solvent Y less than 0.20% Solvent Z less than 0.05%
Moisture content	Karl Fischer titration	Less than 0.5%
pH of 1% solution	pH measurement	4.60–5.00

D. New Drug Application/Marketing Authorization Application Stage

From the standpoint of specifications, by the time a drug has reached the new drug application (NDA)/marketing authorization application (MAA) stage, it will have been in development for a number of years. It is likely that the drug substance is being manufactured by the proposed commercial synthesis route. Normally, an extensive body of data is available on drug characteristics, physical properties, impurities, stability, etc., on which to base meaningful specifications. However, data will still be relatively limited compared to a drug that has been approved and marketed for a number of years, so care must be taken not to lock into stringent acceptance criteria that might not be regularly achieved in a normal long-term production environment. The drug product will in all likelihood be the actual, or very close to the actual, formulation that is intended for the marketplace.

By the NDA preparation stage, the process of setting specifications will also involve a firm's manufacturing operations and quality control/assurance groups. Manufacture of batches of drug substance and product will be transferred to the firm's operations group from research and development, and both sets of personnel will have been involved in manufacturing transfers, analytical transfer and method validation, and agreement on specifications.

Plans will be made to submit an NDA based on the whole body of development data available, and prior to this the development and manufacturing teams need to be running programs in conformance with the International Conference on Harmonization (ICH) guidelines. The following sections describe the guidelines, which detail the requirements for setting specifications, as well as those that relate closely to this. The guidelines are applicable to both chemical and biotechnological products, but the focus in this chapter will be given to drugs manufactured by chemical synthesis and products made from them. The principles in all ICH quality guidelines can apply to both chemical and biotechnological products.

III. INTERNATIONAL CONFERENCE ON HARMONIZATION GUIDELINES

A. Background to the International Conference on Harmonization

Prior to the late 1980s, there was a proliferation of regulatory guidelines in different countries for all aspects of data required for regulatory submission, covering all kinds of topics from clinical data requirements to the stability testing of drug substances. It was recognized at that time that this miscellany of regulations was leading to repetitive, redundant work, slowing down the availability of new drugs to patients, increasing the cost of drug development, and generally making the development process rather inefficient. Against this background, the regulatory authorities and drug industry in the three major global pharmaceutical regions—the United States, Europe, and Japan—came together to create the International Conference on Harmonization (ICH). Extensive information on the ICH, as well as all the guidelines, can be found on the following Web site: <http://www.ich.org/>.

The ICH was created around 1990 and is concerned with the harmonization of technical requirements for the registration of products among these three major markets. The terms of reference of the ICH are as follows:

- To provide a forum for a constructive dialogue between regulatory authorities and the pharmaceutical industry on the real and perceived differences in the technical requirements for product approval in the United States, Europe, and Japan
- To identify areas where modifications in technical requirements or greater mutual acceptance of research and development procedures could lead to a more economical use of human, animal, and material resources, without compromising safety
- To make recommendations on practical ways to achieve greater harmonization in the interpretation and application of technical guidelines and requirements for registration

The ICH is a joint regulatory/industry undertaking and the six co-sponsors of the conference are

Europe: European Commission (EC) and the European Federation of Pharmaceutical Industry Associations (EFPIA)

Japan: Ministry of Health and Welfare (MHW) and the Japanese Pharmaceutical Manufacturers Association (JPMA)

United States: Food and Drug Administration (FDA) and the Pharmaceutical Research and Manufacturers of America (PhRMA)

Some organizations, including the Canadian Health Protection Branch and the United States Pharmacopeia (USP), act as observers to the conference working committees, and their input is also influential in the guideline-setting process. In addition, the International Federation of Pharmaceutical Manufacturers Associations (IFPMA) acts as an “umbrella” organization and provides the ICH secretariat to coordinate the preparation of documentation.

Three separate areas of regulatory requirements were identified for harmonization, namely, safety, efficacy, and quality, and a working party for each was established to define topics for discussion. Within the quality section, the following five topics were selected for initial harmonization:

- Q1—stability testing
- Q2—analytical method validation
- Q3—impurity testing
- Q4—pharmacopeial harmonization
- Q5—quality of biotechnological and biological products

The sixth topic to be set up was Q6—Specifications: Test Procedures and Acceptance Criteria for New Drug Substances and New Drug Products. Two guidelines were developed, one covering synthetic chemical drugs (Q6A) and one covering biotechnologically produced drugs (Q6B). Details of these are described in Sections III.B and III.C.

The development and issuance of ICH guidelines is a five-step process, briefly outlined as follows:

Step 1. Preliminary discussions of the topic are held by a group of experts, mandated by the ICH steering committee, and a preliminary draft is prepared. The draft is discussed by the joint industry/regulatory ICH expert working group under the leadership of a “rapporteur.” This process usually results in numerous drafts and iterations of a guideline before consensus is achieved. The process can take several years.

Step 2. The draft is transmitted to the three regional regulatory agencies for formal consultation in accordance with their internal consultation procedures.

Step 3. The draft is amended, if necessary, in the light of the consultation process. The revised draft is discussed by the joint industry/regulatory expert working group.

Step 4. The final draft is endorsed by the steering committee, which recommends adoption by the three regulatory bodies.

Step 5. The recommendations are incorporated into domestic regulations or other appropriate administrative measures, according to national/regional internal procedures.

B. Guideline Q6A—Specifications for New Drug Substances and Products: Chemical Substances

The first expert working group on this topic¹ was set up in early 1996 with the objective of setting guidance for a common approach toward the setting of specifications for synthetic chemical drug substances and the products made from them. A companion guideline Q6B² addressing the special specification requirements for drugs of biotechnological origin was also initiated at the same time.

The original intention of Q6A was to provide guidance for all types of drug formulations. This would have included products such as solid dosage forms (immediate-release and delayed-release tablets, hard-gelatin and softgel capsules, chewable tablets, fastmelt tablets, etc.); liquid dosage forms such as solutions, suspensions, and emulsions; injectable products (sterile liquids and lyophilized vials, etc.); inhalation products (metered dose inhalers, aerosols, etc.); skin patches for dermal delivery; and semisolid products such as creams, ointments, and gels.

It quickly became apparent that such a task would be overwhelming in the short time frame available and that special expertise would be required for certain products such as inhalation and dermal delivery systems. The decision was then made to limit the drug products covered by the guideline to those that included the vast majority of marketed dosage forms, that is, immediate-release and delayed-release tablets, capsules, oral liquids, and parenteral products.

In addition to the six regular members of the expert working group (FDA, PhRMA, EC, EFPIA, MHW, and JPMA), this topic had additional members from the pharmacopeial organizations, the USP, the Japanese Pharmacopoeia (JP), and the European Pharmacopoeia (EP), as well as representation from the generic drug industry. This was to ensure adequate representation from those bodies outside the innovative pharmaceutical industry and regulatory agencies that would be affected by any requirements contained in this guideline. As will be seen, the representation of pharmacopeial agencies was crucial, because many global specifications need harmonization of monographs within the individual pharmacopeias.

1. Objective of Q6A

The guideline is intended to assist in the establishment of a single set of global specifications. It provides guidance on the setting and justification of acceptance criteria and the selection of test procedures for new drug substances of synthetic chemical origin and new drug products made from them, which have not previously been registered in the United States, the European Union, or Japan.

2. Scope of the Guideline

The scope highlights the fact that setting specifications is only one step in the process of ensuring the availability of medicinal products that are safe, effective, and of high quality. Other factors include design, development, in-process controls, process validation, and good manufacturing controls. The guideline covers only the marketing approval stage of drug substances and products, not those at the clinical testing stage.

Given the complexity of some of the dosage forms mentioned earlier, this guidance was limited to solid oral dosage forms, liquid oral dosage forms, and parenterals (small and large volume). These products serve as models, and the principles applied can be used for all other dosage forms such as inhalation products, topical formulations, and transdermal systems.

3. General Concepts

A number of general concepts are described in the guideline, including the following:

a. Periodic and Skip Testing

This is the performance of specified tests at release on preselected batches and/or at predetermined intervals, rather than on a batch-to-batch basis. The concept might be applied postapproval because often only limited data are available at the time of submission of an application.

b. Release Versus Shelf Life Acceptance Criteria

This concept applies to drug products only and pertains to the setting of more restrictive limits for the release of a drug product compared to the shelf life.

c. In-Process Tests

These are tests that can be performed during the manufacture of a drug substance or product, rather than part of the battery of tests that are conducted prior to release. Excluded are tests that are used for the purpose of adjusting the operating parameters of a manufacturing process, for example, hardness testing of tablet cores that will ultimately be made into coated tablets.

d. Design and Development Considerations

The experience and data accumulated during the development of a new drug substance or product should form the basis for the setting of specifications.

e. Availability of Limited Data

It is recognized that only a limited amount of data is available at the time of submission and acceptance criteria need to be set with this in mind, with the possibility to amend (either tighten or loosen) the specifications at a later date.

f. Parametric Release

This can be used as an alternative to routine release testing of the drug product. The most common example is sterility testing of terminally sterilized injectable products, whereby the release of a batch is based on monitoring certain parameters during the manufacturing cycle, such as temperature and pressure.

g. Alternative Analytical Procedures

For example, if tablets have been shown not to degrade, then it may be permissible to use a nonstability-indicating analytical method for release

(e.g., spectrophotometry), rather than a more specific procedure such as chromatography.

h. Pharmacopoeial Tests and Acceptance Criteria

Several tests are essentially already harmonized across the USP, JP, and EP and among these are

- Sterility
- Residue on ignition/sulfated ash
- Bacterial endotoxins
- Color/clarity
- Particulate matter
- Dissolution apparatus
- Disintegration apparatus

Some other tests are under harmonization discussion and among these are

- Dissolution (media and acceptance criteria)
- Disintegration (media and acceptance criteria)
- Uniformity of mass
- Uniformity of content
- Extractable volume
- Preservative effectiveness (scope of test and acceptance criteria)
- Microbial contamination

An important statement made in this guideline to address the future harmonization of other test methods is as follows:

The full utility of this Guideline is dependent on the successful completion of harmonization of pharmacopoeial procedures for several attributes commonly considered in the specification for new drug substances or new drug products. The Pharmacopoeial Discussion Group of the European Pharmacopoeia, the Japanese Pharmacopoeia and the United States Pharmacopoeia has expressed a commitment to achieving harmonization of the procedures in a timely fashion.

i. Evolving Technologies

This concept was introduced to take into account the continuously developing technologies of analytical chemistry and to leave options open for the replacement of older methodology by new procedures, when appropriate.

j. Impact of Drug Substance on Drug Product Specifications

This concept refers to the fact that it should not be necessary to test the drug product for quality attributes uniquely associated with the drug substance. For example, it is not normally necessary to test the drug product for synthesis impurities that are not degradation products and that have been tested in the drug substance.

k. Reference Standard

A reference standard, or reference material, is a substance prepared for use as the standard in an assay, identification, or purity test.

4. Justification of Specifications

The guideline describes the process of setting and justifying specifications. For example, justification will refer to development data, pharmacopeial standards, test data from toxicology and clinical studies, and results from stability testing. Additionally, it is important that expected analytical and manufacturing variability should be considered. If multiple manufacturing sites are being considered for the drug substance or products, then data from the different sites will be valuable in setting the specifications. If a test, which would normally be included, is to be omitted, then justification needs to be provided, for example, from data generated during development. When only limited data are available, then the initially approved test and acceptance criteria should be reviewed as more information is collected, with a view toward possible modification. This could involve loosening, as well as tightening, acceptance criteria, as appropriate.

5. Universal Tests and Criteria

The guideline introduces the concept of universal tests for both drug substances and drug products. These are tests that would generally be applied without exception and that would be added to by specific tests, depending on the nature of the particular substance or product. For both drug substances and drug products, universal tests include

- Description
- Identification
- Assay
- Impurities

For drug products, impurities relate to degradation products rather than to impurities from the method of manufacture.

6. Specific Tests and Criteria

a. New Drug Substances

The following tests are listed as being applicable to certain drug substances under a variety of circumstances.

Physicochemical Properties. These include pH of aqueous solution, melting point, and refractive index. Tests in this category should be determined by the physical nature of the drug substance and its intended use.

Particle Size. For substances to be used in certain formulations such as solid or suspension products, the particle size can have a significant effect on dissolution rates, bioavailability, and stability. A decision tree in the guideline provides guidance as to when particle size testing should be considered.

Solid-State Forms. This section addresses the fact that some drug substances exist in different physical forms such as polymorphs or solvates. Differences in these forms could, in some cases, affect the quality or performance of the new drug products. In cases where differences exist that have been

shown to affect product performance, bioavailability, or stability, the appropriate solid state should be specified. The guideline contains decision trees, which, when followed, sequentially provide guidance on when, and how, solid-state forms should be monitored and controlled.

Analytical techniques commonly used to check for solid-state characteristics include melting point (including hot-stage microscopy), solid-state infrared spectroscopy, x-ray powder diffraction, thermal analysis (e.g., differential scanning calorimetry, thermogravimetric analysis, and differential thermal analysis), Raman spectroscopy, scanning electron microscopy, and solid-state nuclear magnetic resonance (NMR).

The sequential decision tree approach considers whether polymorphism in a drug substance can affect performance of the drug product and leads to a final decision point for determining whether polymorph specifications need to be set for a drug product.

Tests for New Drug Substances That Are Optically Active. Chiral impurities had been excluded from ICH guidelines on impurities because of the practical difficulties of measuring them. However, in Q6A, a decision tree describes if, and when, chiral identity tests, impurity tests, and assays may be needed for both new drug substances and products, according to criteria such as the following:

- *Impurities.* For single-isomer drug substances, the other enantiomer should be considered the same as any other impurity.
- *Assay.* An enantioselective determination should be part of the specification.
- *Identity.* The identity test should be capable of distinguishing between a single isomer and its opposite enantiomer.
- *Drug product.* Control of the other enantiomer is necessary if it is a degradation product. Where the enantiomer is not a degradation product, an achiral assay may be sufficient for assay measurement, and an identity test should be established that is capable of verifying the presence of the correct enantiomer or racemate, as appropriate.
- *Water content.* This is important where the new drug substance is known to be hygroscopic or degraded by moisture. A specific test such as Karl-Fischer titration is preferred.
- *Inorganic impurities.* The need for these tests should be based on knowledge of the manufacturing process. Tests could include, for example, sulfated ash/residue on ignition or atomic absorption spectroscopy.
- *Microbial limits.* A decision tree is provided in the guideline to indicate when microbial testing should be applied.

b. New Drug Products

In addition to the universal tests described earlier, specific tests and acceptance criteria should be included for particular new drug products. The guideline does not include in its scope all conceivable dosage forms, largely because of limitations of time and the need to recruit expertise in some of the more specialized dosage forms such as inhalation products and transdermal

delivery systems. The guideline limits itself to those common dosage forms representing the vast majority of pharmaceutical sales, that is, solid oral drug products, liquid oral drug products, and parenterals (small and large volume). However, application of the concepts in this guideline should be made to other dosage forms.

For tablets and hard-gelatin capsules, the following specific tests are generally applied:

- *Dissolution and disintegration testing.* For rapidly dissolving products with highly soluble drug substances, disintegration testing may suffice. When dissolution is considered necessary, in the majority of cases, single-point measurements are normally considered to be suitable. For modified-release dosage forms, appropriate test conditions should be considered. For extended-release products, multiple-time-point testing should be done. Where multiple-time-point acceptance criteria are necessary, *in vitro/in vivo* correlation may be used to establish acceptance criteria. Decision trees are presented to help provide additional guidance on the use of dissolution and disintegration testing.
- *Hardness/friability.* If these characteristics have a critical impact on product quality (e.g., chewable tablets), acceptance criteria should be included in the specification.
- *Uniformity of dosage units.* This test includes uniformity of both content and mass.
- *Water content.* This should be included when appropriate.
- *Microbial limits.* A decision tree is provided to aid in selecting if, and when, microbial testing should be performed on finished oral solid dosage forms. Skip testing might be an appropriate approach in this case.

For oral liquids and powders intended for reconstitution, some of the following specific tests will be applicable:

- *Uniformity of dosage units.* Generally, acceptance criteria should be set for weight variation, fill volume, and/or uniformity of fill. For powders intended for reconstitution, uniformity of mass testing is generally considered acceptable.
- *pH.* pH criteria should be set where applicable and the range justified.
- *Microbial limits.* Acceptance criteria should be set for the total count of aerobic microorganisms, the total count of yeasts and molds, and the absence of specific objectionable bacteria. A decision tree is provided in the guideline to aid in deciding which would be appropriate microbial tests.
- *Antimicrobial preservative content.* For liquids requiring an antimicrobial preservative, acceptance criteria for preservative content might be appropriate. Antimicrobial effectiveness should be demonstrated during product development, and then release testing should be performed to ensure the appropriate preservative content.
- *Antioxidant preservative content.* When an antioxidant is required in a product to maintain stability, development studies should confirm the

requisite amount, and then that amount should be confirmed as present in the product at initial release. Normally, an antioxidant is degraded during shelf life while undertaking its preservative action, so shelf life testing is of little relevance. This is a situation in which data derived during product development will be of prime importance.

- *Extractables*. Development data can often show that a test for extractables is redundant, but when leaching of extractables can result in interaction between a product and its container/label/closure system, an extractables test might be appropriate.
- *Alcohol content*. When declared on the label, a specification limit should be set for alcohol content.
- *Dissolution*. In the case of a suspension or dry-powder product intended for reconstitution, it might be necessary to include acceptance criteria for dissolution. Acceptance criteria should take into account the dissolution profiles of products that showed acceptable performance in vivo.
- *Particle size distribution*. This test might be required for oral suspensions. It might also be proposed in place of dissolution testing, and, in this case, a justification for the substitution will be required. Dissolution profiles obtained for products showing acceptable performance in vivo should be used as a basis for the acceptance criteria.
- *Redispersibility*. For an oral suspension that settles on storage, a redispersibility test might be required. Time required to achieve resuspension by a particular procedure should be defined.
- *Rheological properties*. For viscous solutions or suspensions, it may be appropriate to include rheological properties (viscosity) in the specification.
- *Specific gravity*. The specific gravity may be included in liquid product specifications.
- *Reconstitution time*. Acceptance criteria should be provided for the reconstitution time of dry-powder products that require reconstitution.
- *Water content*. The water content should be included as a test for oral products requiring reconstitution.

For parenteral drug products, the following tests are generally appropriate:

- *Uniformity of dosage units*. Generally, acceptance criteria should be set for weight variation, fill volume, and uniformity of fill.
- *pH*. pH limits should be set where appropriate and the proposed range justified.
- *Sterility*. This is a critical test for parenteral products. Where data generated during development and validation justify parametric release, this approach may be proposed for terminally sterilized products.
- *Endotoxin testing*. Endotoxin testing should be included.
- *Pyrogen testing*. Pyrogen testing could be proposed as an alternative to endotoxin testing where justified.
- *Particulate matter testing*. Particulate matter testing will normally include limits for visible particulates and/or clarity of solution, as well as for subvisible particles.

- *Water content.* Water content should be established for nonaqueous parenterals and for products intended for reconstitution. Loss on drying is normally sufficient if the effect of absorbed moisture versus water of hydration has been adequately characterized during development.
- *Antimicrobial preservative content.* When a preservative is required in a parenteral product, the content should be based on the lowest specified content necessary to maintain the microbiological product quality throughout its shelf life.
- *Antioxidant preservative content.* Release testing should normally be performed. Shelf life testing may be unnecessary and in-process testing may suffice in lieu of release testing.
- *Extractables.* Control of extractables can be very important for parenteral products. Elimination of the test may be proposed if development has shown no significant evidence of extractables.
- *Functionality testing of delivery systems.* Formulations packaged in pre-filled syringes, autoinjector cartridges, or the equivalent should have test procedures and acceptance criteria related to the functionality of the delivery system.
- *Osmolality testing.* Osmolality testing should be performed when the tonicity of a product is declared on the label.
- *Particle size distribution.* Development data should be considered when determining the need for either a dissolution procedure or a particle size distribution procedure.
- *Redispersibility testing.* Redispersibility testing will be required for injectable suspensions that settle on storage.
- *Reconstitution time testing.* Reconstitution time testing should be provided for all parenteral products that require reconstitution.

The guideline finally provides a glossary of all the important terms contained in the various sections of the document.

C. Guideline Q6B—Specifications: Test Procedures and Acceptance Criteria for Biotechnological/Biological Products

This guideline is similar in general principles to Q6A, but takes into account the special requirements that pertain to biological molecules. For example, the scope of the guideline applies to thoroughly characterizable proteins and polypeptides, their derivatives, and the products of which they are components (e.g., conjugates) and which are isolated from tissues, body fluids (including blood plasma), and cell cultures or produced using r-DNA technology. The guideline contains full details of the following factors.

I. General Principles

Some of the general principles covered include the following.

a. Characterization and Quantitation Considerations

These include determination of physicochemical properties, biological activity, immunochemical properties, and purity. The product should be compared with an appropriate reference material or its natural counterpart.

Physicochemical Properties. These will generally include determination of the composition, physical properties, and primary structure.

Biological Activity. Potency, measured by a suitably quantitative method, should be based on the attribute of the product that is linked to the relevant biological properties. Examples of methods to measure the biological activity include animal-based bioassays, cell-line-based bioassays, and biochemical assays using measures such as enzymatic or immunochemical reactions. Alternative methods can be used, and any method used needs to be justified. Results of activity should be calibrated against a national or international reference standard when available. Where sufficient physicochemical information about the drug, including higher order structure, can be thoroughly established, a bioassay to measure biological activity may not be required.

Immunological Properties. These should be examined by methods such as immunoassay, immunoelectrophoresis, and antibody neutralization.

Purity, Impurity, and Contaminants

- Absolute purity is difficult to measure and is method dependent. Limits should be based and justified on preclinical, clinical, and manufacturing experience with the product.
- Where possible, biological activity and immunoreactivity should be investigated. Impurities that are selected for inclusion in the specifications are “specified impurities” and limits should be established. Impurities can be process or product related and can be of known structure, partially characterized, or unknown.
- Contaminants include chemical/biochemical and microbiological species not intended to be part of the manufacturing process. They should be suitably controlled with appropriate action limits or specifications.

Quantity. This critical parameter will be based on measurement of protein content, usually by a physicochemical measurement.

b. Analytical Considerations

In this section, guidance is given on the selection of reference standards and materials, as well as analytical method validation.

c. Process-Related Considerations

Guidance is provided on process validation, in-process specifications, and action limits. The concept of the use of internal action limits is described, to control the consistency of the process at less critical stages. Data obtained during development and validation runs should provide the basis for provisional action limits to be set for the manufacturing process. Approaches to the testing of raw materials, components, and excipient specifications are described.

d. Compendial Specifications

Such monographs and test methods applicable to biological/biotechnological products generally include, but are not limited to, requirements for

sterility, pyrogenicity, bioburden, volume in container, content uniformity, and particulates.

e. Release Versus Shelf Life Limits

This is a similar concept to that described in Section III.B.3.b for chemical substances.

f. Statistical Concepts

Appropriate statistical analyses should be applied when necessary to quantitative data.

2. Justification of the Specifications

Points that should be taken into consideration when establishing scientifically justifiable specifications include the following:

- Specifications should be linked to a manufacturing process.
- Specifications should account for drug substance and product stability.
- Specifications should be linked to preclinical and clinical studies.
- Specifications should be linked to methods.
- Specifications should be linked to a cumulative database.

3. Specifications

Tests should be drug and product specific.

a. Drug Substance

The specification should contain the following tests and acceptance criteria:

- Compendial specifications such as endotoxin detection by limulus amoebocyte lysate (LAL) or pyrogen testing
- Appearance/description
- Identification—tests should be highly specific and based on unique aspects of the drug's molecular structure; examples of commonly selected parameters and methods include

Chemical reaction, instrumental analysis, chromatography, electrophoresis

Assay (immunoassay, receptor assay, in vitro bioassay, in vivo bioassay)

Enzymatic reactivity

Molecular weight [e.g., by techniques such as sodium dodecyl sulfate–polyacrylamide gel electrophoresis (SDS–PAGE), SE–high-performance liquid chromatography (SE–HPLC)]

Isoelectric point

Specific activity

Amino acid composition

Peptide mapping

Carbohydrate-chain mapping/microheterogeneity pattern in case of glycoproteins

- Purity and impurities (process and product related)
- Potency
- Quantity

b. Drug Product

Dosage forms may include, but are not limited to, parenterals, topicals, solutions, powders for reconstitution, and inhalants. Tests to be conducted will include a selection from the following:

- Compendial (e.g., sterility, endotoxins, microbial limits, volume and container, particulates, content uniformity, preservative assay, moisture)
- Appearance/description
- Identification—similar approach to drug substance
- Potency
- Quantity
- Excipient testing—tests might be needed for those excipients that are critical to product quality and function such as preservatives and antioxidants

4. Glossary and Appendix

The guideline provides an extensive glossary of terms used. In the appendix, guidance is given on testing and setting specifications for a variety of parameters such as amino acid composition, terminal amino acid sequence, sulfhydryl groups and disulfide bridges, peptide maps, amino acid sequence, carbohydrate composition, spectrometric composition, spectrometric profiles, isoelectric point, molecular weight, electrophoretic patterns, and liquid chromatographic patterns.

D. Other Quality Guidelines Relevant to Setting Specifications

An important reminder here is that all ICH guidelines apply only to the marketing authorization stage of development and not to the clinical research stages of development. There are several other guidelines that will be used to generate data on which acceptance criteria for specifications will be based. These are described in the following sections.

I. QI—Stability Testing

a. Guideline Q1A⁴

This guideline describes requirements for the submission of stability data at the time of a new drug application. It covers guidance on such things as stress testing, formal stability studies, selection of batches for study, test procedures and test criteria, specifications, storage conditions for both long-term testing and accelerated testing, testing frequency, packaging and containers, evaluation of data, labeling statements, together with a glossary of terms. This guideline is very relevant to specifications because knowledge of the stability and shelf life characteristics of drugs and products is essential to setting meaningful specifications. Of particular relevance are the data generated on decomposition products that will be used to set acceptance criteria for these at the end of the product shelf life.

b. Guideline Q1B⁵

This guideline covers photostability testing. Until the generation of this guideline, there had been little guidance from any agency on the subject, so it helped establish principles of light testing for the first time. The document covers testing within and outside of drug product packs, as well as light sources and a recommended procedure for conducting testing, together with a description of quinine chemical actinometry.

c. Guideline Q1C⁶

This guideline covers stability testing of new dosage forms. Basically, the requirements are similar to those in Q1A.

In summary, results of stability testing are related to the specifications that are set for both drug substances and products, because the allowable levels of degradation products and shelf life assay values for parent drug are assessed from the results of stability testing.

2. Q2—Analytical Method Validation**a. Guideline Q2A⁷**

This guideline refers to terms and definitions of parameters included in validation experiments, whereas Q2B describes the way in which validation can be performed. Attributes covered in Q2A include specificity (for identification tests); accuracy, precision, specificity, detection limit, quantitation limit, linearity, and range (for impurity tests); and accuracy, precision, specificity, linearity, and range for assay measurements (e.g., content, potency, and dissolution testing).

b. Guideline Q2B⁸

This guideline, titled “Validation of Analytical Procedures: Methodology,” describes methods for the experimental determination of specificity, linearity, range, accuracy, precision (including repeatability, intermediate precision, and reproducibility), detection limit, quantitation limit, robustness, and system suitability testing. Because analytical methods are a key component of establishing specifications for drug substances and products, validation of those methods is a key factor in establishing reliable and usable specifications.

3. Q3—Impurities**a. Q3A—Impurities in New Drug Substances**

Impurities in drug substances are very important for setting specifications. Impurities can range from the innocuous to the extremely toxic, and it is vital that impurities are characterized and carefully controlled. Generally, synthesis impurities are not tested in the final drug product, so it is important that they are understood and controlled at the drug substance stage. Q3A⁹ covers the following topics:

- Classification of impurities, as follows:

Organic impurities, which cover starting materials, by-products, intermediates, degradation products, or reagents, ligands, and catalysts

Inorganic impurities, which cover heavy metals, inorganic salts, reagents, ligands, and catalysts, and other materials such as filter aids and charcoal

Residual solvents, which are organic or inorganic liquids used during the manufacturing process (in fact, a separate guideline has been issued on residual solvents, and details are provided in Section III.D.3.c)

- Rationale for the reporting and control of impurities
- Analytical procedures
- Reporting impurity content of batches
- Specification limits for impurities
- Qualification of impurities—this section addresses the evaluation data for assessing the biological safety of an individual impurity or a given impurity profile at the levels specified.

A decision tree is provided that enables a logical sequence to be followed, culminating, if necessary, in toxicology studies to assign safe levels to impurities.

b. Q3B—Impurities in New Drug Products

This guideline¹⁰ was based on Q3A, with application of many of the same principles. However, the guideline addresses only those impurities in drug products that could be classified as degradation products of the drug substance or reaction products of the active ingredient with an excipient and/or immediate container/closure system. Impurities arising from excipients present in the drug product were not covered by this guideline. It was considered that impurities in drug substances that were not degradation products were already controlled by the specification for the drug substance.

The guideline describes the need to specify limits for the following types of impurities:

- Specified degradation products (i.e., those that are known and characterized)
- Any unspecified degradation products (i.e., those that are recurring but as yet not identified conclusively)
- Total degradation products

A decision tree for qualification to establish the biological safety of an impurity is described.

An important feature of this guideline is the concept of thresholds for (a) reporting of degradation products, (b) identification of degradation products in new drug products, and (c) qualification of degradation products. These concepts take into account the increased difficulty of measuring impurities in drug products compared to drug substances, and are summarized as follows:

- *Reporting.* The threshold for reporting a degradation product is set at 0.1% and 0.05% for drugs with maximum daily doses of less than or equal to 1 g and greater than 1 g, respectively.
- *Identification.* Thresholds for identification are set as follows:

Maximum daily dose	Threshold
Less than 1 mg	1.0% or 5 µg TDI, weil
1–10 mg	0.5% or 20 µg TDI, weil
Greater than 10 mg–2 g	0.2% or 2 mg TDI, weil
Greater than 2 g	0.1%

TDI, total daily intake; weil, whichever is lower.

- *Qualification.* Thresholds for qualification are as follows:

Maximum daily dose	Threshold
Less than 10 mg	1.0% or 50 µg TDI, weil
10–100 mg	0.5% or 200 µg TDI, weil
Greater than 100 mg–2 g	0.2% or 2 mg TDI, weil
Greater than 2 g	0.1%

TDI, total daily intake; weil, whichever is lower.

c. Q3C—Residual Solvents

This guideline¹¹ was drafted as a joint working group exercise between experts from both the analytical chemistry and the toxicology fields. Residual solvents in pharmaceuticals are defined as the organic volatile chemicals that are used or produced in the manufacture of drug substances or excipients or in the preparation of drug products.

To set specifications that will ensure safe and good-quality drug substances and products, the inherent toxicity of each solvent needs to be understood. This guideline divides solvents into three classes. Class 1 includes those with unacceptable toxicities, which should normally be avoided. Class 2 solvents are those that should be limited in order to protect patients from potential adverse effects. Class 3 are less toxic and of lower risk, and specification limits of up to 0.5% in the drug substance are normally acceptable. Limits for these should be set on the basis of ensuring good manufacturing practice (GMP) and to be consistent with a good-quality product, rather than on their toxicity. In the guideline, upper limits are given for each solvent in classes based on available toxicology data.

The guideline applies mainly to drug substances and excipients, because if the levels of residual solvents in those materials are controlled, then the levels in drug products made from them are defined. The exception is when a solvent is used in the manufacturing process for a drug product, for example, the solvent-based film coating of tablets. In this case, a specification for the solvent must be set for the drug product.

The guideline contains extensive lists of solvents of all three classes, with limits for each. Known toxicology data are given for each solvent, with definitions for parameters and methods of establishing exposure limits such as permitted daily exposure (PDE), no-observed-effect level (NOEL), lowest-observed-effect level (LOEL), tolerable daily intake (TDI), and acceptable daily intake (ADI).

TABLE 3 Residual Solvents in Classes 1–3

Class 1	Concentration limit (ppm)	Class 2	Permitted daily intake (mg/day)	Class 3 (limits set by GMP requirements)
Benzene	2	Acetonitrile	4.1	Acetic acid
Carbon tetrachloride	4	Chlorobenzene	3.6	Acetone
1,2-Dichloroethane	5	Chloroform	0.6	Anisole
1,1-Dichloroethane	8	Cyclohexane	38.8	1-Butanol
1,1,1-Trichloroethane	1500	1,2-Dichloroethane	18.7	2-Butanol
		Dichloromethane	6.0	Butyl acetate
		1,2-Dimethoxyethane	1.0	<i>tert</i> -Butylmethyl ether
		<i>N,N</i> -Dimethylacetamide	10.9	Cumene
		<i>N,N</i> -Dimethylformamide	8.8	Dimethyl sulfoxide
		1,4-Dioxane	3.8	Ethanol
		2-Ethoxyethanol	1.6	Ethyl acetate
		Ethyleneglycol	6.2	Ethyl ether
		Formamide	2.2	Ethyl formate
		Hexane	2.9	Formic acid
		Methanol	30.0	Heptane
		2-Methoxyethanol	0.5	Isobutyl acetate
		Methylbutyl ketone	0.5	Isopropyl acetate
		Methylcyclohexane	11.8	Methyl acetate
		<i>n</i> -Methylpyrrolidone	48.4	3-Methyl-1-butanol
		Nitromethane	0.5	Methylethyl ketone
		Pyridine	2.0	Methylisobutyl ketone
		Sulfolane	1.6	2-Methyl-1-propanol
		Tetralin	1.0	Pentane
		Toluene	8.9	1-Pentanol
		1,1,2-Trichloroethane	0.8	1-Propanol
		Xylene	21.7	2-Propanol
				Propyl acetate
				Tetrahydrofuran

An interesting feature of this guideline is that it required the involvement and cooperation of excipient manufacturer organizations; without their acceptance of the proposals, it would not have been possible for pharmaceutical companies to adhere to the new limits and specifications on materials to be included in drug products.

A complete listing of all the solvents described in classes 1–3, with acceptable limits, is shown in Table 3. Solvents for which no adequate toxicological data were found include 1,1-diethoxypropane, 1,1-dimethoxymethane, 2,2-dimethoxypropane, isooctane, isopropyl ether, methylisopropyl ketone, methyltetrahydrofuran, petroleum ether, trichloroacetic acid, and trifluoroacetic acid.

4. Q4—Pharmacopeial Harmonization

This guideline¹² mainly addresses the harmonization of monographs for commonly used excipients, across the United States, European, and Japanese pharmacopeias. Prior to harmonization, manufacturers were required to perform different or replicate tests with different acceptance criteria on many

excipients. This guideline was initiated to gain consensus on tests and limits to be applied to the most common excipients. The expert working group for this guideline comprised membership from the regulatory agencies and the pharmacopeias. Some harmonization of test methodologies was also undertaken.

5. Q5—Guidelines for Biotechnological Products

These^{13–16} are beyond the scope of this chapter but include guidances on viral safety, genetic stability, cell substrate characterization, and the stability of biotechnological products.

6. M4—Common Technical Dossier

As a logical extension of the various harmonized guidelines across the areas of efficacy, safety, and quality, the ICH steering committee initiated working groups to attempt to create a basis for completely harmonized global submissions across the regions of the United States, Europe, and Japan. For quality components of submissions, there are many areas that can be harmonized and the expert working group is working on specific modules.

However, the underlying philosophies of the different regulatory agencies make complete harmonization difficult. For example, the FDA requires access to much more raw data, whereas the European Union has the concept of an “expert report” for different sections of an MAA, and Japan has a summary “gaiyo.” Neither of these latter concepts is part of the FDA’s regulations. In principle, it would be to the pharmaceutical industry’s benefit to have the ability to compile a single submission for all regions, as long as the single submission was based on rational selection of required information and avoided simply compiling the most stringent regulations from each of the agencies.

IV. PHARMACOPEIAS AND SPECIFICATIONS

There are various pharmacopeias worldwide, which, among other things, define the quality attributes of drug substances and, in some cases, drug products (see Chapter 9). Some of the most well known ones include the United States Pharmacopeia (USP),¹⁷ the European Pharmacopoeia (EP),¹⁸ the British Pharmacopoeia (BP),¹⁹ and the Japanese Pharmacopoeia (JP).²⁰

The USP contains chapters on a variety of topics as well as monographs on drug substances and drug products. Chapters cover analytical techniques for physical, chemical, and biological testing, as well as a variety of general analytical topics such as specifications for reagents and containers. The USP has a number of subcommittees of volunteers from industry, academia, and government who take responsibility for the review and approval of monographs submitted from companies and chapters written by individuals. The USP laboratory undertakes analytical testing and validation of new methods, and the standards division provides analytical reference standards for public sale.

The EP covers only drug substances, whereas the BP and JP include both drug substances and drug products. The JP contains descriptions of general

tests, processes, and apparatus; official monographs; infrared reference spectra; and general information.

One of the factors affecting industry's dependence on the worldwide pharmacopeias is that the differences between certain tests and monographs can lead to duplicate or replicate testing of the same drug or formulation for acceptance for use in different parts of the world. The ICH Q4 and Q6 guidelines are both attempting to correct this. In the case of Q4, a number of excipient monographs have been harmonized, and this reduces testing requirements within companies and is a much more logical approach to quality control testing in this age of global pharmaceutical development and manufacture. In the case of Q6, as mentioned earlier, there is still a need to harmonize a number of analytical tests.

There is also an International Pharmacopoeia,²¹ which is focused on the needs of developing countries and takes into account the need for simple, classical physicochemical analytical techniques that have been shown to be sound. Whenever possible, classical procedures are used throughout so that the pharmacopoeia can be applied without the need for expensive analytical equipment. In addition, alternative methods have been introduced for use whenever a more complex method is suggested. Priority is given to drugs that are widely used throughout the world. High priority is given to medicines that are important to World Health Organization programs and that may not appear in any other pharmacopeias.

V. STATISTICAL CONSIDERATIONS IN SETTING SPECIFICATIONS

The acceptance criteria for tests in a specification can be set only after due attention is paid to the variability of the criteria. For example, both manufacturing processes and analytical methods are subject to degrees of variability, depending on the nature of the process or test. Considering analytical methods, some are inherently more accurate than others. For example, titrimetry typically exhibits coefficients of variation (COVs) that are lower than for methods such as chromatography. One has to bear this in mind when setting specifications for chromatographic procedures. It is possible to define a titrimetric value for a drug substance assay to within say $\pm 0.5\%$, whereas typically HPLC methods exhibit COVs of around $\pm 1\%$.

There are many texts and publications²²⁻²⁴ that describe the statistical methods that can be applied to the analytical concepts involved in setting specifications and in quality control. Sampling is important, particularly for diffuse materials such as drug substances and powdered granulations. A specification must always be set to result in a decision as to whether a batch should be rejected or released, based on a sample drawn randomly from the product batch. Process control is important and is based on control charting, targeting a specific test parameter value. If the parameter being measured (e.g., drug content of tablets, impurity content of drug substance, dissolution results of capsules, polymorph ratio of drug substance, etc.) falls outside a specific range, then it is an indication that a manufacturing process is out of control. The variability of analytical methods and the variability of a manufacturing process are

intimately connected in the setting of specifications. Specifications must be set sufficiently tightly to ensure consistent product quality, but not so tight that normal manufacturing variance would cause regular batch failure.

Statistical concepts employed in setting specifications and their relationship to product quality control include accidental and systemic errors, frequency distributions, measures of dispersion, standard deviations, standard errors, and sampling plans. In summary, specifications must be set by taking into account

- Manufacturing variability
- Analytical variability
- Sampling techniques

VI. SUMMARY

In summary, the setting of specifications is an important concept in the overall goal of ensuring that safe and effective products are consistently made available to patients. The development of a final specification is an evolving process based on a continuous collection of data throughout research and development from the first drug synthesis to commercial batch manufacture. Specifications evolve during that process to the point at which, in a marketing approval application, a formal specification can be set that encompasses all that has been learned about the drug substance and its formulations during development.

From the regulatory perspective, the ICH has created a strong process for providing valuable guidelines to aid a manufacturer in setting consistent specifications that will be accepted by regulatory agencies in the three major pharmaceutical marketplaces of the United States, Europe, and Japan. However, specifications are just one part of an overall manufacturing philosophy that must include appropriate product design, development, and manufacturing systems and controls, good manufacturing practice, with personnel experienced and well versed in good production processes and techniques.

REFERENCES

1. Specifications for new drug substances and products: Chemical substances. ICH Guideline Q6A. ICH Secretariat, c/o International Federation of Pharmaceutical Manufacturers Associations, 30 Rue de St-Jean, PO Box 9, 1211 Geneva 18, Switzerland.
2. Specifications: Test procedures and acceptance criteria for biotechnological/biological products. ICH Guideline Q6B. Details as in reference 1.
3. Guideline for the format and content of the chemistry, manufacturing and controls section of an application. In *Getting Your Drug Approved: FDA's Own Guidelines*, 2nd ed. Washington Business Information, Inc., Arlington, VA, 1990.
4. Stability testing of new drug substances and products. ICH Guideline Q1A. Details as in reference 1.
5. Stability testing: Photostability of new drug substances and products. ICH Guideline Q1B. Details as in reference 1.
6. Stability testing for new dosage forms. ICH Guideline Q1C. Details as in reference 1.
7. Text on validation of analytical procedures. ICH Guideline Q2A. Details as in reference 1.
8. Validation of analytical procedures: Methodology. ICH Guideline Q2B. Details as in reference 1.

9. Impurities in new drug substances. ICH Guideline Q3A. Details as in reference 1.
10. Impurities in new drug products. ICH Guideline Q3B. Details as in reference 1.
11. Impurities: Guideline for residual solvents. ICH Guideline Q3C. Details as in reference 1.
12. Pharmacopoeial harmonization. ICH Guideline Q4. Details as in reference 1.
13. Viral safety evaluation of biotechnology products. ICH Guideline Q5A. Details as in reference 1.
14. Quality of biotechnological products: Genetic stability. ICH Guideline Q5B. Details as in reference 1.
15. Quality of biotechnological products: Stability testing of biotechnological/biological products. ICH Guideline Q5C. Details as in reference 1.
16. Quality of biotechnological/biological products: Derivation and characterization of cell substrates used for production of biotechnological/biological products. ICH Guideline Q5D. Details as in reference 1.
17. United States Pharmacopeia, USP 24, NF19 (2000), 1999. United States Pharmacopeial Convention, Inc., 12601 Twinbrook Parkway, Rockville, MD 20852.
18. European Pharmacopoeia 1997. Council of Europe, 67075 Strasbourg Cedex, France, 1996.
19. British Pharmacopoeia 1999. British Pharmacopoeia Commission, Market Towers, 1 Nine Elms Lane, London SW8 5NQ, UK.
20. Japanese Pharmacopoeia 1996. Society of the Japanese Pharmacopoeia, 2-12-15, Shibuya, Shibuya-ku, Tokyo, 150 Japan.
21. International Pharmacopoeia, Vol. 4. World Health Organization, Geneva.
22. Chatfield, C. *Statistics in Technology—Studies in Applied Statistics*. Penguin, Baltimore, 1970.
23. Harper, W. M. *Statistics. M and E Handbooks: Business and Management*, 5th ed., 1988.
24. Topping, J. *Errors of Observation and Their Treatment. The Institute of Physics and The Physical Society Monographs for Students*. Chapman & Hall, London, 1969.

This Page Intentionally Left Blank

12

VALIDATION OF PHARMACEUTICAL TEST METHODS

JONATHAN B. CROWTHER

Ortho-Clinical Diagnostics, Raritan, N.Y. 08869

- I. BACKGROUND AND CHAPTER OVERVIEW
 - A. Introduction
 - B. Interrelated Elements to Ensure Reliability of the Analytical Methodology
- II. VALIDATION TERMINOLOGY AND DEFINITIONS
- III. METHOD DEVELOPMENT AND ITS INFLUENCE ON METHOD VALIDATION
 - A. Method Development Life Cycle
 - B. "Deliverables" of the Method Development Process to Support Validation Activities
- IV. VALIDATION REQUIREMENTS OF THE METHOD
 - A. Noncompendial Methods
 - B. Compendial Analytical Procedures
- V. VALIDATION DOCUMENTATION
- VI. VALIDATION EXPERIMENTATION
- VII. METHOD TRANSFER
 - A. Transfer Documentation
 - B. Method Transfer Protocol
 - C. Method Transfer Experimental Portion
 - D. Transfer Summary and Approval
- VIII. REVALIDATION
- IX. REFERENCE STANDARDS
 - A. Types of Standards
 - B. Handling of Standards
- X. SUMMARY
- ACKNOWLEDGMENTS
- REFERENCES

I. BACKGROUND AND CHAPTER OVERVIEW

In its basic form, analytical method validation is the process of demonstrating that analytical procedures are suitable for their intended use. More specifically, analytical method validation is a matter of establishing documented evidence that provides a high degree of assurance that the specified method will consistently provide accurate test results that evaluate a product against its defined specification and quality attributes.¹ The U.S. Federal Register states that, "validation data must be available to establish that the analytical procedures used in testing meet proper standards of accuracy and reliability."² All analytical procedures require some form of validation, regardless of whether the method is used for stability, in-process analysis, release, or acceptance testing.

This chapter will discuss an approach to method validation that will meet these challenges. Many of the discussions will focus on the validation of high-performance liquid chromatography (HPLC) methods using assay and purity determinations; nevertheless, fundamentals of the approach can be applied to most method validation activities. In the end, a method must be properly developed to facilitate straightforward validation. Therefore, general method development practices are reviewed as well.

A. Introduction

Because many analytical test methods are expected to ultimately be used in a quality control environment, they require an additional degree of refinement compared to research methods;³ methods for multilaboratory use are also required to be robust. An additional goal of this chapter is to describe validatable, transferable, robust, reliable, accurate, and precise (V-TR²AP) methodology,⁴ as the validation process requires quality method development. Because validation can be a time consuming, methods should not enter the validation phase unless they are fully developed. The following observations can be made about the relationship between validation and method development:

- When methods are properly developed, they readily validate.
- Validation is not a method development tool—validation does not make a method good or efficient.⁵
- A validated method does not necessarily imply a V-TR²AP method.
- Validation acceptance criteria should be based on method development experience.

The method development scientist should not enter the validation process unless he or she is confident of success. The validation process is “confirmation” that the method is suited for its intended purpose; there should be few “surprises” in the validation results, because prevalidation evaluation data should suggest that the method will validate successfully. Method validation is also a “holistic” process that requires suitable instrumentation and competence in laboratory techniques to ensure success.

Although the requirements of validation have been clearly documented by regulatory authorities,^{6,7} the approach to validation is varied and open to interpretation. The following approach will focus on the International Conference on Harmonization (ICH) guidelines. Also, because validation requirements differ during the development process of pharmaceuticals, this chapter will emphasize requirements for later stages of development and for methods used to evaluate marketed products.

Prior to beginning validation, controls should exist to ensure that the method has been properly developed and is capable of the objectives outlined prior to beginning the method development endeavor. Because validation is considered a good manufacturing practice (GMP) activity, validation experiments must be properly documented and performed on qualified and calibrated instrumentation and equipment. At this stage, there should be documented evidence that the method is robust. A generalized flowchart of the validation process is detailed in Figure 1.

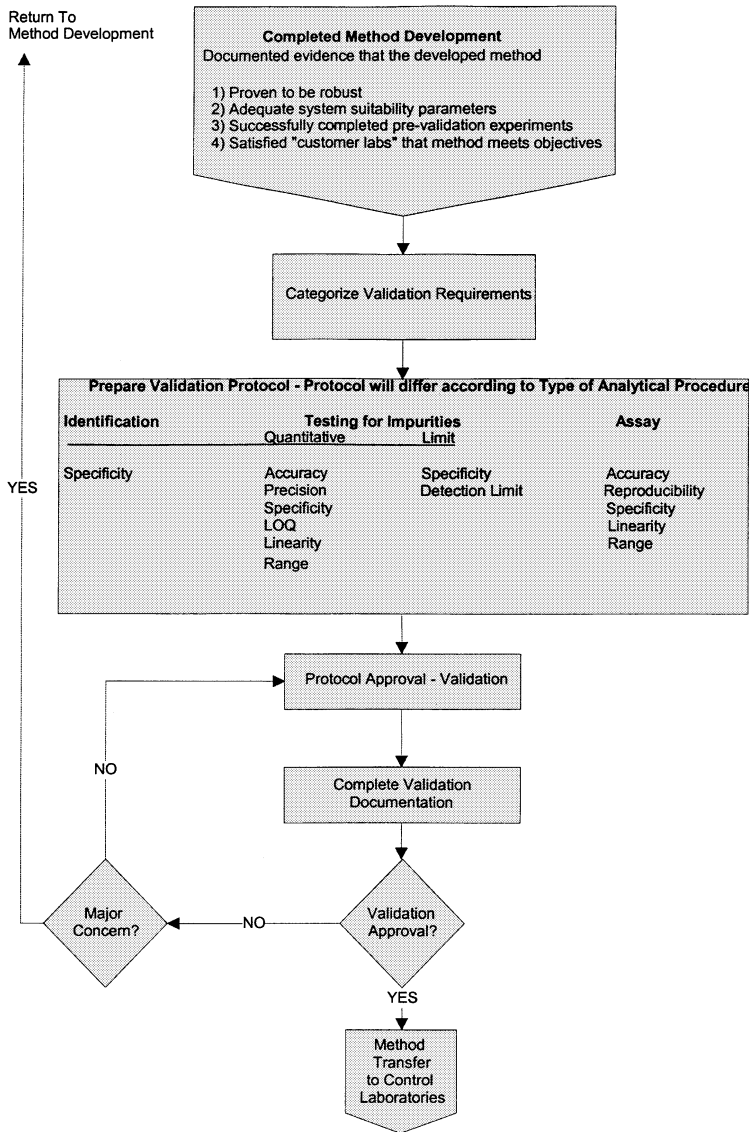

FIGURE 1 Generalized validation flowchart.

B. Interrelated Elements to Ensure Reliability of the Analytical Methodology

Government agencies require accurate information and data recorded both in regulatory filings and in day-to-day operations of pharmaceutical manufacture. From a pharmaceutical laboratory’s perspective, analysts need to ensure the accuracy and reliability of the data generated by their test methods. As shown in Figure 2, there are required and fundamental controls that ensure the overall quality of the analytical test data. The interdependent processes represented in Figure 2 correlate to ensure the quality of the reported data.

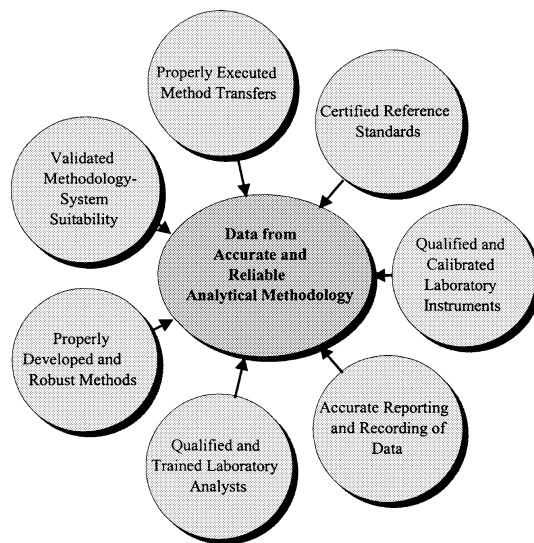

FIGURE 2 Unified elements that ensure reliability of data from analytical methodology.

This chapter, while focus on the validation process, will also expand on the importance of adequate method development, suitable reference standards, and approaches to method transfer. A brief discussion of the other elements listed in Figure 2 can be found elsewhere.⁴

II. VALIDATION TERMINOLOGY AND DEFINITIONS

It is important to define the terms used in regulatory guidelines when discussing method validation. In the following definitions, the *italic* portions are quoted directly from the ICH guideline.⁸

Accuracy. “*The accuracy of an analytical procedure expresses the closeness of agreement between the value which is accepted either as a conventional true value or an accepted reference value and the value found.*” “Method accuracy is the agreement between the difference in the measured analyte concentrations of fortified and unfortified samples..., the fortification procedure is called spiking.”⁹

Precision. “*The precision of an analytical procedure expresses the closeness of agreement between a series of measurements from multiple sampling of the same homogeneous sample under prescribed conditions. Precision may be considered at three levels: Repeatability, intermediate precision, and reproducibility.*”

Repeatability. “*Repeatability expresses the precision under the same operating conditions over a short interval of time.*”

Intermediate precision. “Intermediate precision expresses within laboratories’ variations: Different days, different analysts, different equipment, etc.”

Reproducibility. “Reproducibility expresses the precision between laboratories.”

Specificity. “Specificity is the ability to assess unequivocally the analyte in the presence of components which may be expected to be present.”

Detection Limit. “The detection limit of an individual analytical procedure is the lowest amount of analyte in a sample which can be detected but not necessarily quantitated as an exact value.”

Quantitation Limit. “The quantitation limit of an individual analytical procedure is the lowest amount of analyte in a sample which can be quantitatively determined with suitable precision and accuracy.”

Linearity. “The linearity of an analytical procedure is its ability (within a given range) to obtain test results which are directly proportional to the concentration (amount) of the analyte in the sample.”

Range. “The range of an analytical procedure is the interval between the upper and lower concentration (amounts) of the analyte in the sample (including these concentrations) for which it has been shown that the analytical procedure has a suitable level of precision, accuracy, and linearity.”

Robustness. “The robustness of an analytical procedure is the measure of its capacity to remain unaffected by small, but deliberate, variations in method parameters and provides an indication of its reliability during normal usage.”

Ruggedness. The United States Pharmacopeia (USP)¹⁰ defines ruggedness as “the degree of reproducibility of test results obtained by the analysis of the same samples under a variety of normal test conditions, such as different labs, different analysts, different lots of reagents, Ruggedness is a measure of reproducibility of test results under normal, expected operational conditions from laboratory to laboratory and from analyst to analyst.” See Intermediate precision.

Sensitivity. The sensitivity of an analytical method is equal to the slope of the calibration line in a linear system.

III. METHOD DEVELOPMENT AND ITS INFLUENCE ON METHOD VALIDATION

A. Method Development Life Cycle

The method development “life cycle” parallels established approaches to analytical method validation¹¹ and computer validation.¹² Clearly, analytical

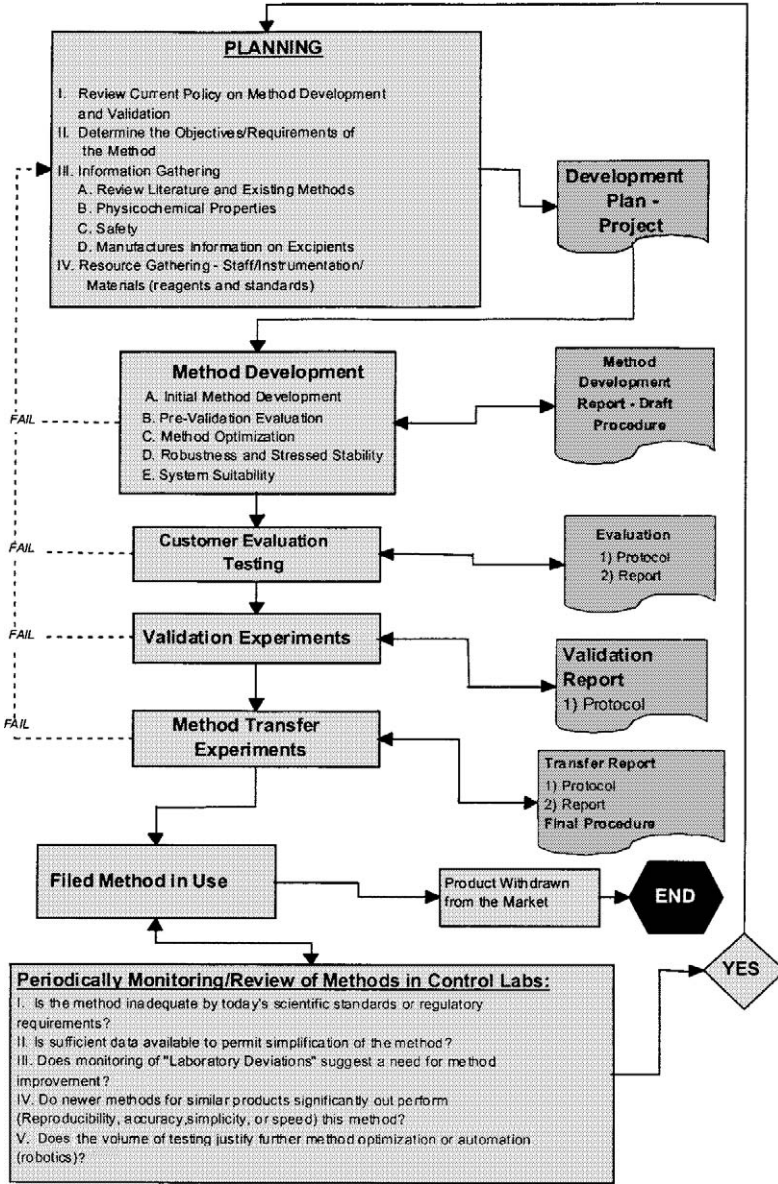

FIGURE 3 V-TR² AP methodology life cycle.

methods have finite lifetimes and should be reviewed periodically and then revised or changed if required. Figure 3 provides an overview of the organizational components of the pharmaceutical method development life cycle. Successful implementation of the method development process requires careful planning and development of the requirements of the method, excellence in laboratory work, qualified instrumentation, and proper documentation from beginning to end (see Chapters 10 and 15). Indeed, the goals of any analyti-

cal development project should include the “scope,” designing flexibility and robustness into the procedure, understanding the needs and environment of the lab where the method will ultimately transfer, and taking into account validation requirements. The method developers need to strive to minimize the effort required to use the method and simplify processing and interpretation of the data. The method development process outline in Figure 3 includes different stages that should be considered during development; these activities should be executed with consideration of current ICH guidelines.

Planning. Planning encompasses the user requirements of the method. Planning includes the following major items:

- Determine the purpose and regulatory requirements of the method.
- Gather existing information (technical and safety) of the drug substance, known related substances, and formulation ingredients.
- Understand customer expectations (e.g., analysis time, ease of use, analysis costs, available instrumentation, etc.).
- Establish a method development time line.
- Estimate the requirements and availability of resources (reference standards, instrumentation, technical staff, etc.).
- Understand the technical method requirements (analytical equipment, chemicals used, required sensitivity, selectivity, chirality, etc.).
- Examine the compliance requirements for the method.
- Through analysis of batch surveys and stability data, determine and identify specified related substances ($\geq 0.1\%$); unspecified related substances (typically occurring at levels between 0.05 and 0.10%) should also be determined.

Goal: All related substances must be chromatographically resolved from the active substance; nothing should coelute with a specified related substance. Unspecified related substances could coelute with each other but must not coelute with the active, specified related substance or an excipient of the formulation.

- Review data, deviations, and reports on earlier method versions, noting that a “crossover” study may be required in the plan to correlate the two methods.

Method Development. Once the plan and resources are in place, the laboratory portion of the method development process can begin. For example, in the case of chromatographic method, after chromatographic parameters have been adjusted to enable proposed resolution of related substances in a reasonable analysis time, the methodology is assessed for the following:

- Can the method be further optimized to be more practical and efficient?
- Will the method validate (prevalidation studies)?
- Is the method specific and stability indicating as shown by stressed stability (pH, light, heat, oxidation) studies?
- Do we have useful and meaningful system suitability criteria?
- If this is a rework of an existing method, has a crossover study been performed to compare the two methods?

Robustness Testing. Robustness testing studies the capacity of the method to remain unaffected by small, but deliberate variation in the method parameters. By means of a limited set of experiments (often using an experimental design approach), the critical parameters that may affect the ruggedness of the method can be identified, understood, and improvements made if necessary.

Customer Evaluation Testing. Customer evaluation testing allows the testing and receiving laboratories (the expected customers) to check whether a method performs adequately for its intended purpose. This evaluation should consider the specific country's compliance requirements with respect to the analytical methods. The customer evaluation permits direct customer feedback to the development lab prior to validation studies.

Validation. Validation is the process of collecting documented evidence that the method performs according to its intended purpose (see Planning). This is based on analytical experiments performed according to the validation protocols that comply with the international guidelines on method validation. A brief description of the validation process is reviewed in Figure 4. For general HPLC assay/purity methods, the following validation parameters will typically be evaluated:

- Specificity
- Linearity
- Accuracy
- Range
- Precision (repeatability, intermediate, reproducibility)
- Limit of detection/quantitation
- Solution stability (recommended)

Robustness, specificity (evaluated through stressed stability), and system suitability have been evaluated prior to the validation exercise and will be discussed in additional detail later.

Method Transfer. Method transfer is the process of collecting documented evidence that the receiving laboratories (customers) are capable of running the method. This is based on analytical experiments showing the equivalence of the analytical results obtained in the development and receiving laboratories. These experiments are set up according to the transfer protocol that should contain preapproved acceptance criteria.

Method Evaluation and Method Modification. If a method is to be modified or changed, the process should be guided using established change control systems. The newer methodology should be correlated with the existing methodology through a crossover study that evaluates data from a variety of samples analyzed by the two methods.

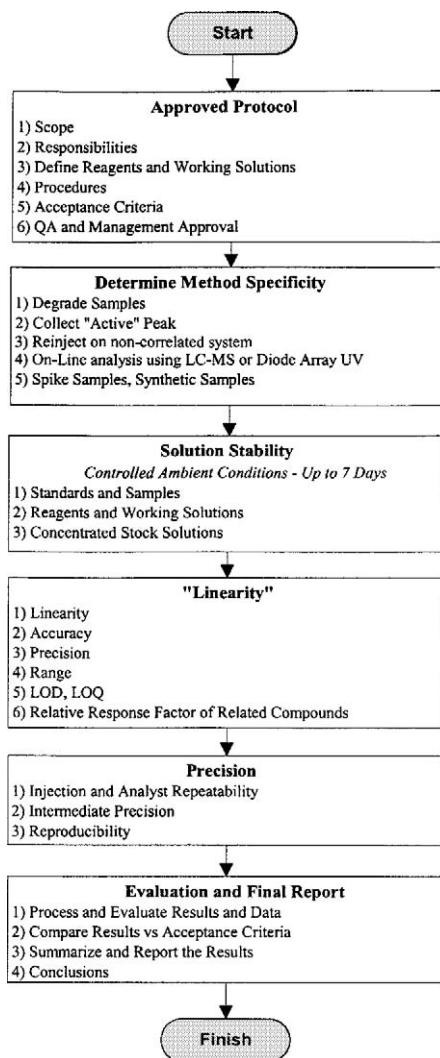

FIGURE 4 Generalized validation process for an HPLC assay/purity method.

B. “Deliverables” of the Method Development Process to Support Validation Activities

Prior to beginning the validation activities, the following deliverables should be complete from the method development exercise and reports available: (1) method robustness, (2) method optimization, (3) method specificity, (4) system suitability, (5) method procedure, and (6) preliminary validation experiments used to establish validation acceptance criteria.

I. Method Robustness

The ability of a method to perform effectively in a typical lab environment and with acceptable variations is evaluated during robustness testing.

Generally, if robustness is designed into the method development process, the methods should transfer more readily. The successful performance of a test method may be sensitive to the setting of some operational parameters. In robustness testing, a variety of parameters are evaluated to determine the extent to which they can be varied without affecting the performance of the method. In an HPLC experiment, the following representative parameters (factors) may be evaluated:

- HPLC manufacturer
- Lot-to-lot column variation
- Column supplier
- Flow rate
- Column temperature
- Mobile phase pH
- Ionic strength
- Detector wavelength
- Gradient slope
- Injection size, sample concentration

Some but not all of these factors may need to be evaluated for robustness testing based on general knowledge or experience during method development. The range (levels) over which the various parameters are evaluated should be meaningful; that is, will the method perform successfully if the pH is adjusted ± 0.2 pH units from that specified in the method? Through HPLC experiments, typical “responses” (i.e., capacity factor, resolution, peak tailing) are tracked while factors are adjusted. To optimize the evaluation of robustness, these factors can be evaluated simultaneously through an experimental design approach. Success has been achieved using a two-factor Plackett–Burman statistical approach.¹³ In this approach, 7 factors can be evaluated in 12 injections.

2. Method Optimization

If the method does not meet run time criteria or robustness requirements, it may require further optimization. Method development optimization is typically continued until the objectives outlined in the development plan are met. Method development experts often have the experience necessary to adequately optimize the methodology; others may benefit from the documented and organized development approach of available software packages. Several commercial packages are available that combine classical chromatographic theory with statistical design to predict optimum separation conditions with a minimum number of experiments.

3. Method Specificity

Is the method specific and stability indicating as shown by analysis of samples subjected to stressed stability studies (pH, light, heat, oxidation)? Normally, specificity is determined through peak purity using ultraviolet (UV) diode array or liquid chromatography (LC)/mass spectrometry (MS) analysis. In methods for analysis of drug products, placebo formulations (and stressed placebos) must yield “blank” chromatographic baselines. The development

and validation of stability-indicating assay and purity methods require that studies be performed to verify the method's ability to resolve all possible degradation products and synthetic impurities from the active drug substance while accurately measuring their concentration in the presence of product excipients. Such studies are regarded as a minimum requirement for the development and validation of most any "stability indicating" method.^{14, 15}

4. System Suitability

Generally speaking, it is expected that an analytical test method will perform in an acceptable manner each time it is used. System suitability testing ensures that the total system is functioning at any given time. System suitability testing, coupled with previous instrument qualification, periodic calibration, and method validation, provides assurance that the test method will provide accurate and precise data for its intended use. Properly chosen, system suitability criteria will fail just prior to the point where the system will begin to produce less acceptable data; however, criteria should not be so strict that *acceptable* data cannot routinely be used due to too restrictive criteria. It is the challenge of the method development scientist to develop realistic and meaningful system suitability criteria.^{16, 17} Table 1 reviews some system suitability tests and the associated validation parameters they monitor run to run.

As implied from the preceding discussion, only meaningful system suitability criteria and those required by in-house or regulatory policy should be evaluated. During method development and robustness evaluation, marginal performance of the system can be observed. The experienced and attentive scientist will use these circumstances to suggest some of the system suitability criteria; minimum peak tailing and minimum resolution between "critical peak pairs" are typical examples. System suitability should be monitored over time to verify that the criteria remain realistic and achievable while continuing to provide assurance of the suitable performance of the method.

TABLE I System Suitability Testing to Continuously Monitor Validation Parameters

Validation parameter	System suitability test
Linearity	Control sample or diluted standard (LOQ sample); response is expected to be within acceptable limits compared to 100% standard
Accuracy	Control sample—evaluate standards as "samples"
Precision	RSD of five (or six) injections of a standard
Selectivity	Retention factor Number of theoretical plates Tailing factor Resolution (injection of a resolution mixture)
LOQ/LOD	Injection of a dilution of the standard to verify LOD/LOQ
Stability of solutions	RSD (area) of a series of injections or standards throughout a run

LOQ, limit of quantitation; RSD, relative standard deviation; LOD, limit of detection.

The following system suitability parameters should be included in HPLC methods to evaluate and monitor performance.

Resolution. The resolution (R_s) is a measure of how well two peaks are separated. For reliable quantitation, well-separated peaks are essential. The separation of all peaks of interest is checked visually using a synthetic sample solution. The resolution factor (R) between the critical peak pair is calculated according to the formulas described in USP 24 and the European Pharmacopoeia (EP, 3rd ed.).

Relative Standard Deviation. This serves as a daily evaluation of the repeatability of the system. Often, the relative standard deviation for five or six replicate injections of a reference standard is measured at the beginning of each analysis.

Tailing Factor. The tailing factor is used during SST in the case where there is a tendency to tailing of the peak of the active ingredient or one of the related compounds. This is a critical parameter if peak tailing is exacerbated as HPLC columns age. The tailing factor is calculated according to the formula described in USP 24 and EP (3rd ed.).

Limits of Quantitation. The system's ability to detect the LOQ should be evaluated with each sample sequence. An injection of the LOQ concentration during SS evaluation may also be used as a rough check of the linearity of the system over the range from LOQ to 100% of the target active concentration.

Additional System Suitability Parameters. Other parameters for system suitability testing can be considered (e.g., capacity factor, number of theoretical plates, etc.).

Reference Standard Check. The operating policies of some laboratories require that a duplicate injection of a separately weighed reference solution should be analyzed as a control to serve as a check on the accuracy of the standard weighing. The expected result for the second standard should be $98.0\% \leq \text{reference standard potency} \leq 102.0\%$. Laboratories may also evaluate the change in the system response over time (typically every 10–12 injections) through monitoring variation in the area counts of the reference standard; area counts are anticipated not to change by more than $\pm 2\%$ during a given chromatographic sequence.

5. Method Procedure

The method procedure, description, or STM (standard test method) should contain at a minimum the following information prior to validation:

- An introductory summary, including the scope and principle of the method
- A list of reagents and their specifications (HPLC grade, reagent grade, etc.); any precautions should be included as well—“*test the bottle of*

THF [tetrahydrofuran] to confirm the absence of peroxides, prior to use”

- A list of required standards
- A list of supplies—glassware, filters, etc.
- A list of instrumentation and equipment
- A description of solution preparation (mobile phases, standards, and samples)
- A list of method conditions (flow rate, wavelength, gradient profile, equilibration procedure, etc.)
- Procedure for sample/standard preparation
- System suitability criteria and how to calculate
- If there is no company policy, a suggested sample sequence scheme, including order and number of injections of standards, blanks, system suitability, controls, and samples
- Complete calculations/example calculations, including calibration frequency and how calibration is performed
- A table of analyte relative retention times and relative response factors (RRFs), including excipients peaks
- A representative labeled chromatogram; a separate system suitability chromatogram may also be required

6. Preliminary Validation Experiments

Once the method is determined to be optimum, it is evaluated to see if it will meet validation requirements. In this exercise, the method is challenged in some of the following areas:

1. Target LOQ
2. Method selectivity
 - Placebo; stressed placebo
 - Degraded samples
 - Known impurities and degradants
 - Peak purity—diode array
 - “Collect” active—analyze on HPLC column with different selectivity
3. Linearity of the active component (0–150%)
4. Linearity of the related compounds (0.05–2.0%)

Successful completion of prevalidation assessment suggests that the method is capable of entering the much more rigorous validation stage. The method, however, should be evaluated for robustness and assigned system suitability criteria before formal validation studies begin. Prior to entering time-consuming validation activities, method development progress should be reviewed by the team who initially drafted the method requirements. End-users of the method may desire to “evaluate” the method in their labs during “customer evaluation,” which should enable constructive dialogue with the development scientist prior to time-consuming validation; this evaluation may also facilitate straightforward method transfer.

IV. VALIDATION REQUIREMENTS OF THE METHOD

A. Noncompendial Methods

Clearly, all quantitative analytical methods used to support regulatory filings (setting of specifications, etc.), toxicology testing, release of clinical or marketed materials, and methods used in stability studies require some form of validation; requirements for validation of various analytical methodologies are outlined in both USP and ICH guidelines. Drug registration agencies have accepted these guidelines.

In developing HPLC methodology, these validation requirements stipulate that stability-indicating impurity methods be designed and validated to:

1. Simultaneously separate, identify, and quantitate degradates/impurities from the “active” drug substance
2. Be free from interference from the excipient materials

On the other hand, content uniformity and dissolution methods may not be required to be “stability-indicating” because separation of the active compound and impurities may be determined not to be critical to these tests, particularly when impurities are determined through separate validated methods. These non-stability-indicating methods often offer advantages of simplicity and high sample throughput, along with less validation rigor. Similarly, methods used for drug substance/drug product identification are relatively straightforward to develop and validate.

In summary, many of the requirements of a method development project are being dictated through regulation and internationally accepted guidelines, as well as a knowledge of current “good practice” accepted in the pharmaceutical industry.

B. Compendial Analytical Procedures

The methods provided in official monographs have been validated by the laboratory submitting the monograph and/or other laboratories designated by the USP. This validation has been performed with material produced or used by the laboratory and on equipment contained in the laboratory. It is important for all compendia methods that each individual laboratory performs a scaled-back validation of the method or verification of the method’s suitability in its laboratory.

V. VALIDATION DOCUMENTATION

The validation documentation typically consists of a protocol, test data, and a final report. One approach to simplifying validation documentation is to focus on a thorough protocol with preapproved acceptance criteria. This protocol may have data tables to enter the test results, requiring only a short executive summary to summarize the results and a reference or attachment of raw data. A development lab will often use these well-developed and optimized

master method validation protocols^{18, 19} as templates for subsequent validations. Frequently, a copy of the method procedure and, if possible, a method development report are appended to the validation protocol. In general, the validation protocol should contain the following:

Validation Protocol

1. Method principle/objective
2. List of responsibilities (laboratories involved and their role in the validation)
3. Method categorization according to ICH or USP
4. List of reagents (including test lots) and standards required
5. Test procedures to evaluate each validation parameter and proposed acceptance criteria
6. Plan or procedure when acceptance criteria are not met
7. Requirements for the final report

Appendixes

1. Method development report
2. Method procedure

The validation process cannot proceed until the protocol and all parties involved approve the acceptance criteria.

Once the extensive validation experiments are complete, minor changes to the method description may be required. Typically, these involve adding validation data (RRFs for the related substances, LOQs, etc.) but may also include slight changes to the system suitability requirements due to data from multiple laboratories. There should not be fundamental changes that would alter the principles of the methodology or necessitate revalidation unless a portion of the validation failed, suggesting minor method adjustment and reperformance of the required validation experiments.

VI. VALIDATION EXPERIMENTATION

Depending on the requirements of the validation, there can be a preferred order to efficiently perform the validation experiments. For the specific example of validation of an assay/purity HPLC method, Figure 4 suggests a rational approach.

I. Determination of Method Specificity

Specificity is one of the most important characteristics of a “stability-indicating” method and should be determined as one of the first validation items. A specific method can accurately measure the analyte of interest even in the presence of potential sample components (placebo ingredients, impurities, degradation products, etc.). When criteria for specificity are not met, this often indicates that the method is not sufficiently developed; furthermore, it is likely that criteria for accuracy, precision, and linearity may also not be fulfilled. A major objective of determining specificity is to ensure “peak purity” of

the main compound to be determined, in other words, confirm that no related compound or product ingredient coelutes and interferes with the measurement of the assayed compound. Stressed stability samples are often specified in validation protocols to evaluate peak purity. In addition, the ICH outlines two approaches to further evaluating method specificity for when impurities are and are not available.

a. When Impurities Are Available

Knowledge of degradation and synthetic impurities can be derived from the historical information that has accumulated for the drug substance/product. Ideally, a library of impurity and degradation compound reference standards is synthesized and characterized and sufficient quantities are made available. These compounds can be spiked into the sample matrix (placebo) to determine if the matrix interferes with the quantitation of the compound(s) of interest.

b. When Impurities Are Not Available

When impurities are not available to check method specificity, one federal guideline²⁰ defines several conditions under which various drug substances/product types should be stressed to support the suitability of the method. Depending on the matrix and packaging, these include extremes of acid and heat and high oxygen exposure and light exposure. In the case of drug substances, heat (50°C), light (600 fc), acid (0.1 N HCl), and oxidant (3% H₂O₂) are often used. For drug products, heat, light, and humidity (85%) are used as stress conditions.⁸ Analyte peaks are evaluated for peak purity upon sufficient stress to effect 10–15% degradation.

2. Evaluation of Peak Purity

The peak purity in these degraded or spiked samples should be determined by using specific detection techniques, such as diode array UV or HPLC–MS. Software to evaluate peak purity is often available on commercial diode array and LC–MS data systems. Although both of these detection techniques provide relatively straightforward peak purity evaluations, there are limitations to the appropriateness of this approach. A less direct, but perhaps more persuasive, approach is to isolate the peak of interest and reinject on a chromatographic system that based on a different “noncorrelated” separation mechanism, for example, for evaluating a reversed-phase HPLC method, isolate the peak and reinject on an ion-exchange HPLC system. The chromatogram produced from the ion-exchange system is evaluated to observe any secondary peaks that may have eluted under the peak isolate on the reversed-phase system. Capillary electrophoresis (CE) has also been used extensively as a noncorrelated analytical technique to evaluate peaks isolated from reversed-phase methodology.

3. Demonstration of Linearity and Range: Determination of Relative Response Factor

Linearity is the ability to obtain results that are directly or indirectly (by well-defined mathematical transformation) proportional to the concentration of a substance in a sample within a given range. The range is the interval

between the upper and the lower levels of the analytical method that have been demonstrated to obtain acceptable accuracy, linearity, and precision. Hence, the following parameters are typically evaluated during linearity experiments.

The relationship between the sample concentrations and the corresponding instrumental signals for the majority of analytical techniques²¹ is one of a straight-line (first order) type. A line that fits best through the coordinates of the measured signals and the corresponding concentrations of the sample represents such a relationship. This line, known as the calibration line, is expressed by an estimated first-order equation:

$$Y = aX + b$$

where Y is the measured signal, X the concentration of the sample, and a and b the linear regression coefficients of the line, of which a is called the slope of the line and b the intercept.

The calibration lines are usually calculated by ordinary least squares (OLS) regression. A precondition for the application of OLS regression is that the variance of the signal should be independent from the signal itself. This property is also called homoscedasticity. When this is not the case, one is dealing with a heteroscedastic situation. The heteroscedastic property of data can be observed by reviewing a graph that displays residuals.

a. Linearity of the Active Component

The linearity can be demonstrated by analyzing five or more concentrations of the active compound in the presence of the matrix: for example, 50%, 75%, 100%, 125%, and 150% of the normal sample concentration for a stability-indicating method (three separate preparations at each level). There are also added advantages to evaluating the linearity over the whole range from LOQ to 150%.

Linearity can be established by visual evaluation of a plot of the area as a function of the analyte concentration (Fig. 5). Furthermore, the correlation coefficient, y intercept, slope, and RSD for all the generated response ratios (= area/concentration) should be calculated. The y intercept should statistically not differ from 0. Low levels of the active compound (0.05–1.0%) are also examined to determine its LOQ (Fig. 6).

b. Linearity of the Related Compounds

The linearity should be demonstrated by analyzing five concentrations in the presence of the matrix: at LOQ, at the specification level, at an upper level above specification, and at two intermediate concentrations (e.g., 0.1%, 0.25%, 0.5%, 0.75%, and 1.0 %).

Linearity can be established by visual evaluation of a plot of the area as a function of the analyte concentration. The correlation coefficient, y intercept, slope, and RSD for all the generated response ratios (= area/concentration) should be calculated. The y intercept should statistically not differ from 0. The slopes of these curves (Fig. 7) are divided by the slope of the active compound curve (Fig. 5) to determine the RRFs; these are recorded in the method procedure if the method does not prescribe the use of external standards for related compounds.

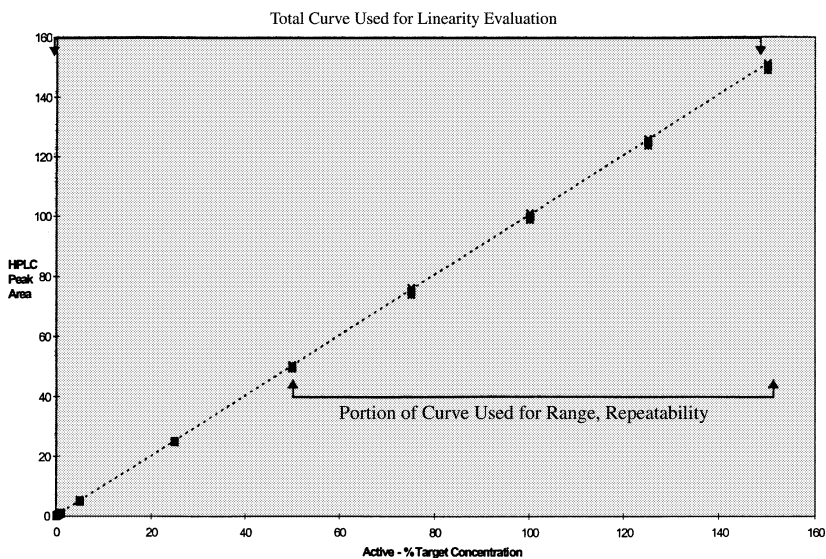

FIGURE 5 Linearity of the active component (0.05–150%).

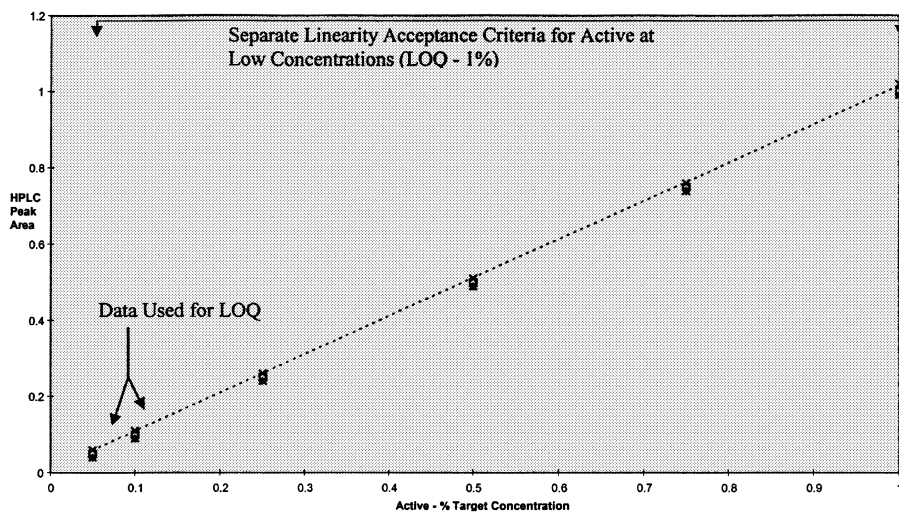

FIGURE 6 Linearity of the active component (0.05–1.0%).

4. Determination of Detection and Quantitation Limits

In the literature, there is some discussion regarding how detection limits are defined, calculated, and interpreted. It is therefore important to state clearly how the detection and quantitation limits should be calculated in the validation protocol.¹⁸ Both the USP and the ICH guidelines similarly define the LOD and LOQ in ways that are widely accepted in the industry. In the most straightforward case, any compound detected with a response at about 3 times the noise response level is construed to be at its LOD. For the LOQ, the value is

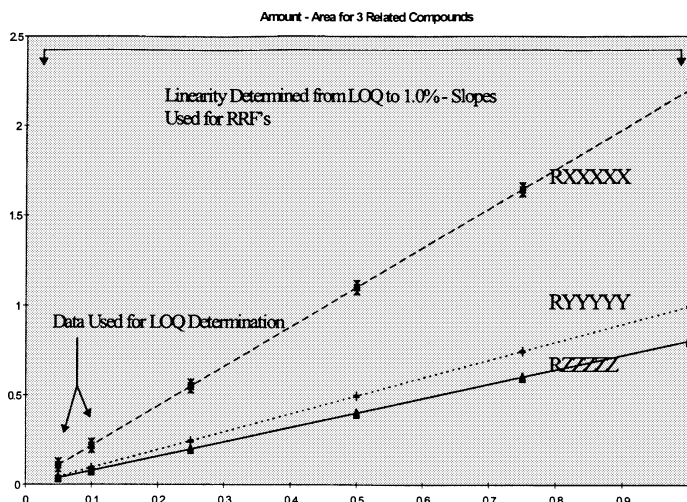

FIGURE 7 Linearity of specified related substances (0.05–1.0%).

very commonly taken as 10-fold the noise response level. Therefore, the LOD and LOQ can be simply determined from the known amount (concentration) of an analyte that produces such responses when the noise level can be easily measured. In fact, some chromatography data systems can be programmed to report baseline noise. An alternative method of determination is described by the ICH guidelines as follows:

$$\text{LOD} = \frac{3.3 \times \text{Std. Error}_{y.\text{int.}}}{\text{Slope}} \quad (1)$$

$$\text{LOQ} = \frac{10 \times \text{Std. Error}_{y.\text{int.}}}{\text{Slope}} \quad (2)$$

This method can be conveniently applied to the regression data obtained in linearity studies. However, parameters estimated by this approach are often verified experimentally. The target limit of quantitation and detection may be stricter for a drug substance than for a drug product. In pharmaceutical analysis of the active drug substance, the target value for the LOQ is typically set at 0.05%.

5. Demonstration of the Accuracy of the Method

This is defined as the closeness of agreement between a test result and the accepted reference value (combination of random and systematic errors). The accuracy is usually examined by determination of the trueness of a test result, which is the closeness of agreement between the average value of a large number of test results and the true result or an accepted reference value. The measure of the trueness is expressed by the bias, which is the difference between the expectation of the test results and an accepted reference value.

The accuracy of a method can be determined by performing recovery experiments, implementing standard addition calibration procedures, testing reference materials, etc. It is also possible to compare the test results of a new

method with those of an existing fully validated reference method¹⁵ through “cross validation” experiments.

Accuracy is often determined by recovery studies in which the analytes are spiked into a solution containing the matrix. The matrix (placebo in formulations) should be found not to interfere with the assay of the compound(s) of interest. For stability-indicating HPLC methods, it is necessary to determine the accuracy of the active ingredient and that of all related compounds. It is possible to determine the accuracy of each related compound separately, but it is more efficient to validate these related compounds in a combined spiked mixture of all the related compounds at their appropriate levels. The analyst should be certain that the impurity standards used to spike the solutions are pure and do not contain significant impurities that would effect the results.

6. Determination of Method Precision

The precision of an analytical procedure expresses the closeness of agreement between a series of measurements obtained from multiple sampling of the same homogeneous sample under the prescribed conditions. Precision may be considered at three levels.

Injection Repeatability. Precision is measured by multiple injections ($n = 10$)²² of the reference standard at the 100% level and indicates the performance of the HPLC instrument using the chromatographic conditions on one particular day and in one lab. The relative standard deviation, RSD(%), as specified here, will determine the lowest variation limit of the analytical results. Injection repeatability indicates the performance of the HPLC instrument using the chromatographic conditions on one particular day and in one lab.

Analysis Repeatability. Analysis repeatability expresses the precision under the same operating conditions over a short interval of time. It typically consists of multiple preparations and measurements of a homogeneous sample by the same analyst on the same day. The analysis repeatability can be determined by assaying 15 individual sample preparations covering the specified range for the procedure (5 concentration levels/3 replicates each).

Intermediate Precision. Intermediate precision expresses the effects of random events on the precision of the analytical procedure within the same lab. The procedure requires repeating the analysis of one technician by a qualified second technician, on a different instrument, using a different lot of HPLC column, on a different day. On the second day of analysis, all reagents and mobile phases are prepared freshly.

7. Target Acceptance Criteria

Table 2 contains an example of validation target acceptance criteria for a stability-indicating HPLC method for the assay of an active drug substance and its related compounds. These criteria or others cited in the literature^{15, 22, 23} can be used as a general guideline when considering acceptance criteria for a validation protocol.

TABLE 2 Example Acceptance Criteria for an HPLC Assay/Purity Method

Parameter	Limit active ingredient	Limit related compounds
Linearity		
Correlation coefficient	>0.99	>0.98
y intercept (relative to the active or related compound)	±2%	±15.0%
RSD response ratios	≤3.0%	≤10.0%
Visual	Linear	Linear
Linearity over the whole range		
Correlation coefficient	>0.99	
y intercept (relative to the active)	±10%	
RSD response ratios	≤5.0%	
Visual	Linear	
Accuracy		
Active ingredient		
Recovery of each over the whole range	96.0–104.0%	
Mean recovery per concentration	98.0–102.0%	
Related compounds		
Mean recovery		
0.05% ≤ x < 0.1%	50.0–150.0%	50.0–150.0%
0.1% ≤ x < 0.5%	70.0–130.0%	70.0–130.0%
0.5% ≤ x < 1.0%	80.0–120.0%	80.0–120.0%
≥ 1.0%	90.0–110.0%	90.0–110.0%
Precision		
Active ingredient		
Injection repeatability	1.0%	
Analysis repeatability	2.0%	
Intermediate precision	3.0%	
Related compounds (analysis repeatability)		
0.05% ≤ x < 1.0%	25.0%	25.0%
0.1% ≤ x < 0.5%	15.0%	15.0%
0.5% ≤ x < 1.0%	10.0%	10.0%
≥ 1.0%	5.0%	5.0%

a. Establishment of Acceptance Criteria Plan if Criteria Are Not Met

When one or more items during method validation fail to meet the acceptance criteria, lab management should decide whether:

1. The results can still be accepted with justification.
2. A retest should be performed on the same sample preparation(s).
3. The test should be repeated (reanalysis).
4. The concern is significant, and the method needs adaptation (through additional method development) after which the test or validation is repeated.
5. As a result of the failure to meet acceptance criteria, a limitation could be put on the method (e.g., range of method limited to 80–120%).

All deviations to the validation procedure should be documented and authorized by lab management and the quality assurance (QA) department. A list of deviations, if any, is included in the final validation report.

VII. METHOD TRANSFER

The transfer of analytical methods may be a component of the overall process of technology transfer involving transfer of several methods simultaneously, or it may be limited to transfer of an existing method to qualify an additional testing site (see Chapter 14). In simplest terms, the analytical method transfer is conducted to ensure the following:

1. Clear understanding of the analytical methodology among the participating laboratories
2. Training of the receiving lab, when required
3. Ability of the receiving laboratory to perform the method
4. Sufficient documentation of the completed and successful transfer

Analytical method transfer should be performed using a validated procedure; this transfer data can be useful in determining “intermediate precision” of the method. The transferring laboratory should ensure that the recipient laboratory(s) is (are) current Good Manufacturing Practice (cGMP) compliant; a record of successful audit by QA personnel is essential, especially if the laboratory is a contractor.

At this stage in the development of a V-TR²AP method, the method is expected to meet the requirements of the proposed testing laboratory. The method should be efficient and practical; reagents, standards, and necessary equipment should be readily available to the testing laboratory. In addition, the validation documentation should be completed and approved along with a background method development report.

A. Transfer Documentation

The method documentation package is typically extensive and should contain the following:

Detailed method. The method procedure should be unambiguous with example chromatograms of the standard, a typical sample, and a system suitability sample with example calculations.

Method development report. The report should review the method development and provide some justification for the choice of key operational parameters and choice of related compounds for purity methods.

Transfer protocol. The protocol should detail the requirements, timing, responsibilities, and acceptance criteria of the transfer.

Validation summary. The transfer documentation should include a summary of the validation activities and results.

The transfer package should be presented to the receiving lab in an understandable format; a review of this documentation is considered “training” and is part of the technology transfer.

B. Method Transfer Protocol

A qualified individual from the transferring laboratory typically writes the method transfer protocol. Management and QA representatives of both the transferring and the receiving laboratory must approve the transfer plan. As a guide, the transfer plan may contain the following:

1. Clear responsibilities of each party
2. Purpose (list all methods to be transferred for the given product and indicate rationale for product methods not included in the transfer)
3. Scope
4. Materials (chemicals, instrumentation, standards, etc.) required in the transfer; standards should be supplied with certificates of analysis
5. Protocols for testing that outline the experiments to be performed
6. Acceptance criteria for the tests
7. Method transfer documentation
8. Copies of the methods
9. Requirements and form of the final report

The batches tested should be selected to challenge the method transfer (i.e., have a sufficient level of impurities/degradants for HPLC impurity methods, samples spiked with impurities, etc.). The batches should test the range of products that are likely to be encountered by the receiving laboratory. The protocol should also include tests to document the receiving laboratory's ability to perform the LOQ determination. The protocol may require training if the technique is new to the receiving laboratory [capillary zone electrophoresis (CZE), LC-MS, etc.]; such training should be documented.

The acceptance criteria should be based on the data obtained for intermediate precision during validation and knowledge of the robustness of the method.

C. Method Transfer Experimental Portion

Transfer experiments are not initiated until the protocol is reviewed and approved by all parties involved. The experiments must be carefully planned to ensure that the proper resources, testing reagents, standards, and laboratory equipment are available. Because transfer experiments are considered a cGMP activity, all instrumentation utilized must be calibrated and qualified; the experiments and data obtained must be properly documented and reviewed.

D. Transfer Summary and Approval

Once the method transfer experimentation is complete, the data are compiled and analyzed, and the final report drafted. The transfer report should indicate whether the transfer was successful and all data recorded and reviewed. The report should indicate the file or location of the raw data. Any deviations to the protocol should be appended to the report.

VIII. REVALIDATION

According to the validation life cycle,²⁴ test methods may require additional validation or revalidation when regulatory agencies issue new requirements or when changes are made to the methodology. Method changes and additional validation activities may be required when there are

1. Instrument changes
2. Product changes
3. Method modifications
4. Analyst changes
5. Outdated technology

Revalidation may be necessary after changes in (a) drug substance synthesis, (b) drug product composition, and (c) the analytical procedure. The degree of revalidation required depends on the nature of the changes made.

IX. REFERENCE STANDARDS

Any discussion of the method development/validation process should consider obtaining a sufficient quantity of a qualified reference standard and appropriate samples to support the development and validation campaign. In most cases, the limit of the accuracy of the analytical test will be related to the correctness of the standard's assay. There is little consensus^{25, 26} on the common requirements of reference standards as outlined by the regulatory authority;²⁷ typical practice favors an approach of thorough analytical characterization of the standard supported by adequate documentation.

A. Types of Standards

Materials selected for use as a standard should be of high purity and stability. Practical and regulatory requirements for reference standards differ, depending on the objective and stage in the drug development cycle. For pragmatic reasons, the reference standard used in the early stages of development may be limited to a well-characterized portion of one of the early lots of material. In later stages, the primary reference standard may be a unique synthesis or a purified version of the material—sometimes in a different salt form to enhance stability or purity. The following sections describe a process of qualification of a reference material:

Primary reference standard of the active compound. The standard of an active compound is typically comprehensively characterized. Table 3 lists the detail required.

Secondary standard (working standard). A material of high purity that has been characterized against a primary or compendial standard. A secondary standard is often used to conserve the amount of primary standard.

Related compound standard. These standards are typically characterized fully, but not to the same extent as the primary reference standard of the active

TABLE 3 Analytical Tests for Certification of Reference Standards

Characterization requirement	Measurement technique
Physical properties	
Proof of structure	Nuclear magnetic resonance (NMR) MS and MS/MS Fourier transform infrared (FTIR) UV spectroscopy Functional group analysis Crystallinity—isoforms Combustion analysis
Physical description	Appearance
Physical properties	Melting point pK _a Optical rotation
Purity	
Related compounds	HPLC purity
Chiral purity	HPLC, CZE chiral purity
Inorganic impurities	Residue on ignition Inductively coupled plasma gas chromatography (ICP GC)
Solvents	Karl Fischer titration
Water	Ion chromatography
Counterions	Thin-layer chromatography (TLC) analysis
Verification—organic impurities	
Assay	
Verification	Titration Assay by difference ^a CH and N analysis Mass balance calculation Titration

^aAssign assay by difference: % assay = 100% – (% impurities/degradants, including solvents) – (% water) – (% other, including counterions).

drug substance. Because quantities of these standards are typically limited, response factors for these standards are assigned to eliminate routine use in HPLC purity determination.

Compendia standard. USP/National Formulary (NF)/American Society for Testing and Materials (ASTM) standards typically do not require further characterization. A certificate of analysis should be available.

Internal standard. Internal standards require a varying amount of characterization, depending on the application. Often, a qualified commercially available standard is chosen.

Other standards. Reagents and chemicals that are commercially available at high purity that have been characterized by the vendor can be suitable for standard materials. Sufficient documentation should be provided by the vendor prior to use.

B. Handling of Standards

1. Storage

When possible, the standard material should be protected from light, heat, and moisture and housed in a controlled environment. Typical storage conditions for a stable solid standard would be a 2–8°C stability room, protected from light, in a desiccator cabinet to protect it from humidity. Reference stock solutions and working solutions should also be labeled with the required storage conditions and expiration dates. The method procedure should specify; the storage conditions and expiry dates should be supported by experimental data. There should be limited access to all standard materials. Although there is a risk of breakage, storage in tightly capped, amber, glass bottles is preferred. Containers should be sized to minimize headspace; small changes to assay have been observed in overly large containers as the solvents and water vapors in the solid standard materials equilibrate with the headspace.

2. Handling

Reference materials must be handled to preserve the integrity of the sample. As discussed previously, the solid materials must be protected from heat, light, and high humidity. Standard materials that are stored at subambient temperatures must be equilibrated to ambient before opening to prevent water condensing on the materials, particularly in humid environments. If primary standard materials are used frequently, qualification of a secondary standard may be justified. Alternatively, primary reference standards can be subdivided into several smaller containers to limit contamination and changes in assay. The retest (recertification) date of the standard should be justified through stability monitoring in the actual storage container.

Certain standards require oven drying prior to use. These drying times/conditions should be adjusted to effect drying of the material and, at the same time, minimize any potential decomposition. Warm standards should be equilibrated to ambient conditions prior to weighing.

3. Documentation

A reference standard must have documentation to support its use as a standard, establish its assigned assay, and defend the retest date (or expiry date for chemical standards).

a. Reference Standard Qualification Report

A detailed qualification report is drafted for a primary reference standard of the active compound; less comprehensive documentation is typical of the other standards. Portions of this report may be submitted to the regulatory authorities. The report references the synthetic route for the standard and any purification schemes that were utilized in preparing the pure standard. Other components of this report may include the following:

- Description or reference to test methods used in characterization of the standard
- Report results of the characterization with representative data (UV, NMR spectra, HPLC chromatograms, etc.)

- Verification of data to establish purity and assay of the standard
- Suggested requirements for requalification interval and requalification tests
- Appendix detailing additional requalification and stability data as they are obtained

b. Certificate of Analysis

In general, all standards should have a certificate of analysis generated either from a qualified supplier or through analysis of in-house data. The certificate should contain the following information:

- Standard name
- Lot number and supplier
- Effective date and recertification date
- Purity
- Assay

c. Dispensing

A reference standard log is typically maintain to provide an inventory of the standard, indicating who, when, and how much standard was removed. Care should be exercised when handling to avoid contamination of the standard. Furthermore, observe safety cautions when handling potent drug substance materials.

X. SUMMARY

Due to the current accuracy and precision in analytical instrumentation, reagents, and capabilities of modern data processing systems, even poor methods may validate to be acceptable. Validation does not necessarily certify a method as “good,” robust, or suitable for a control environment; these must be established within the method during development. It is, however, a necessary and important step in both proving and documenting the capabilities of the method.

This chapter reviewed a systematic approach to method development, validation of analytical methods, and successful transfer of the methods. Successful completion of each component is both a regulatory requirement and good laboratory practice. To ensure that the data are both accurate and reliable, qualified and trained laboratory analysts must perform methods on qualified equipment, using suitable standards.

ACKNOWLEDGMENTS

The author thanks Drs. Ponniah Shenbagamurthi and Ronald Erlich for their reviews and informative discussions during the preparation of this chapter.

REFERENCES

1. Guideline on general principles of validation. U.S. Department of Health and Human Services, Food and Drug Administration, 1987.
2. *Federal Register* 21 CFR 211.165(e) and 211.194 (a)(2).
3. Olson, B. A. and Tsang, P. K. S. Considerations for the development of separation methods for pharmaceutical quality control. *Process Control Quality* 10:25–39, 1997.
4. Miller, J. M. and Crowther, J. B. *Analytical Chemistry in a GMP Environment*. Wiley, New York, 2000.
5. Johnson, J. D. and Van Buskirk, G. E. Analytical method validation. *J. Validation Technol.* 2:88–105, 1998.
6. International Conference on Harmonization. Guideline on validation of analytical procedures: Methodology. *Federal Register* 61:59–62, 1996.
7. Reviewers guidance, validation of chromatographic methods. Center for Drug Evaluation and Research, Food and Drug Administration, 1994.
8. International Conference on Harmonization. Guideline on validation of analytical procedures: Definitions and terminology; availability. *Federal Register* 60:11260–11262, 1995.
9. Jenke, D. R. Chromatographic method validation II. Guidelines for primary validation parameters. *J. Liq. Chromatogr. Related Technol.* 19:737–757, 1996.
10. Validation of compendial methods. United States Pharmacopeia, USP 23, 1225.
11. Hokanson, G. C. A life cycle approach to validation of analytical methods during pharmaceutical product development I. The initial validation process. *Pharm. Technol.* 18:118–130, 1994.
12. PMA Computer Systems Validation Committee. Computer systems validation—Staying current: Introduction. *Pharm. Technol.* 13:60–65, 1980.
13. Jimidar, M., Niemeijer, N., Peeters, R., and Hoogmartens, J. Robustness testing of a liquid chromatography method for the determination of Vorozole and its related compounds in oral tablets. *J. Pharm. Biomed. Anal.* 18:479–485, 1998.
14. Analytical procedures and method validation: Chemistry, manufacturing, and controls documentation. Draft Guidance, August 2000. <http://www.fda.gov/cber/guidelines.htm>.
15. Jimidar, M., Hartmann, C., Cousement, N., and Massart, D. L. *J. Chromatogr., A* 706:479, 1995.
16. Wiggins, D. E. System suitability in an optimized HPLC system. *J. Liq. Chromatogr.* 14:1045–1060, 1991.
17. Wählich, J. C. and Carr, G. P. Chromatographic system suitability tests: What should we be using? *J. Pharm. Biomed. Anal.* 8:619–623, 1990.
18. DeSain, C. Master method validation protocols. *BioPharm* 6:30–34, 1992.
19. Johnson, J. D. and Van Buskirk, G. E. Analytical method validation. *J. Validation Technol.* 2:88–105, 1998.
20. Guideline for submitting samples and analytical data for methods validation. U.S. Food and Drug Administration, 1987.
21. Massart, D. L., Vandeginste, B. G. M., Deming, S. N., Michotte, Y., and Kaufman, L. *Chemometrics: A Textbook. Data Handling in Science and Technology*, Vol. 2. Elsevier, Amsterdam, 1988.
22. Green, J. M. A practical guide to analytical method validation. *Anal. Chem.* 68:305A–309A, 1996.
23. Jenke, D. R. Chromatographic method validation: A review of current practices and procedures II. Guidelines for primary validation parameters. *J. Liq. Chromatogr. Related Technol.* 19:737–757, 1996.
24. Hokanson, G. C. A life cycle approach to the validation of analytical methods during pharmaceutical product Development II. Changes and the need for additional validation. *Pharm. Technol.* 18:92–100, 1994.
25. PMA Workshop on Reference Standards. PMA Analytical Steering Committee, Washington, DC, 1992.
26. Housepian, P. K. Bulk drug substances and finished products. In *Development and Validation of Analytical Methods* (C. M. Riley and T. W. Rpsanke, Eds.). Pergamon, Oxford, UK, 1996.

27. FDA guidelines for supporting documentation in drug applications for the manufacturing of drug substances, 1987.

This Page Intentionally Left Blank

13

STABILITY STUDIES

JESSICA CHA

JOSEPH S. RANWEILER

PHILIP A. LANE

The R. W. Johnson Pharmaceutical Research Institute, Raritan, New Jersey 08869

- I. INTRODUCTION
- II. OPERATIONAL ISSUES
 - A. Introduction
 - B. Protocols
 - C. Documentation
 - D. Schedules
 - E. Stability Reports
 - F. Audits and Inspections
- III. EXCIPIENTS
 - A. Formulation Development
 - B. Stability of New Excipients
 - C. Probe Stability
 - D. Examples of Excipient Stability Information
 - E. Stability of Excipients—Bound and “Unbound” Water
 - F. Conclusion
- IV. DRUG SUBSTANCE
 - A. Developmental Stability Testing
 - B. Batch Selection
 - C. Specifications and Test Methods
 - D. Storage Conditions
 - E. Testing Frequency
 - F. Stability Commitments
 - G. Data Evaluation
- V. DRUG PRODUCT
 - A. Stability Testing During Drug Development—Phases I, II, and III
 - B. Packaging/Containers
 - C. Testing Frequency
 - D. Storage Conditions and Period
 - E. Data Evaluation
 - F. Statements and Labeling
 - G. Postmarketing Changes
- VI. SUMMARY
- GLOSSARY
- APPENDIX
- REFERENCES

I. INTRODUCTION

Patients taking a pharmaceutical product for a particular malady expect the product to be safe and efficacious. Pharmaceutical regulatory agencies worldwide demand that the product retains its identity, quality, purity, and potency

for the time the product is commercially available. Consequently, the agencies expect to see stability data supporting the proposed expiration date of the product in the marketing submission.

Various stability guidelines have been published over the last 5 years describing the types of studies and types of data needed to satisfy regulatory agencies worldwide. Currently the guidelines promulgated by the International Conference on Harmonisation (ICH) are the most commonly accepted. In ICH guideline Q1A(R)¹ the United States, Japan, and the European Union (EU) countries established the principle that stability data generated in any of the three regions would be mutually acceptable in the other two. In the United States the current Food and Drug Administration (FDA) draft stability guidance² and the Section on Pharmaceutical Dosage Forms < 1151 > in *USP 24–NF 19*³ reflect the ICH guidelines. All other countries are generally covered by the stability requirements established by the World Health Organization (WHO).^{4, 5}

In the broadest sense, the stability studies that are conducted should provide evidence of how the quality of the drug substance and drug product changes over time when subjected to various environmental conditions, such as temperature, humidity, and light. In addition, the impact of other variables also needs to be studied. Although not an all-inclusive list, some of the variables are different packaging components and configurations and manufacturing variables, such as process modifications, batch size changes, equipment train differences, manufacturing site changes, and excipient vendor changes. Any proposed modification to the drug substance or the drug product should be carefully evaluated to determine how much stability data will be needed to obtain approval. In the United States postapproval changes can be classified into different categories and, depending upon the change classification, different amounts of stability data will need to be provided.

In the following sections, the operational issues that must be considered to operate a viable, flexible stability program for excipients, drug substances, and drug products will be presented.

II. OPERATIONAL ISSUES

A. Introduction

This section will discuss the fundamental components for organizing and running a stability program. Topics to be covered are the design and implementation of the stability program and the specific studies, the methods and equipment required to administer the studies, and the documentation needed to effectively plan, execute, and report the results of the studies. The design and reports of the studies are regulated by various governing organizations and written guidelines that help specify the requirements of the agencies to which the results of the studies will be submitted in regulatory filings. These guidelines also offer a degree of consistency and an assurance of the acceptance of the study design. This section will cover aspects such as written protocols with the ability to amend the studies based on the data obtained. The protocol

is the single most important document for the execution of the studies; however, documents such as stability data tables (reports), testing schedules and assay sheets, deviation reports, out-of-specification (OOS) reports, and batch and package documentation will also be discussed.

I. Phase of Development

Although individual organizations may refer to the development phases differently, for the purpose of this discussion a product will go through four phases during its life cycle.

The four phases of development are the following:

1. Phase I: safety in healthy subjects
2. Phase II: safety and efficacy in patients
3. Phase III: definitive clinical efficacy studies
4. Phase IV: postapproval studies for other indications

During the various phases of development, the specific need for stability data changes.

To support phase I studies, the evaluation of the drug substance's chemical and physical properties and stability is the primary focus. Studies should include salt selection, probe stability studies to evaluate relative stability of the drug substance and its degradation pathways, excipient compatibility studies, and additional characterization of the drug substance. Stability studies should be part of the selection process for choosing the lead candidate for development. During this development phase a simple clinical dosage form is developed. For phase I the stability studies are short and focused on supporting the short-term clinical trials.

To support phase II development, the stability studies are required to run longer to support the longer clinical studies. During this phase, the focus also shifts to formulation development in preparation for the market image product. Multiple formulations and package materials are generally screened for this purpose; therefore, the use of short-term (6-month maximum) probe stability studies can be used initially, followed by longer-term (2–3 years) studies for the selection of the best candidate formulation. The drug substance should also be monitored for stability with studies lasting 2–5 years.

By phase III development, the dosage form and strength have been determined. During phase III, the formal stability batches are made and put in the proposed packages, and stability testing is initiated. For these studies, the use of regulatory guidelines is critical for the proper design of the studies to support the filings in the targeted market countries and to support shelf life and storage recommendations.

Phase IV occurs after product approval and launch and the typical stability studies are focused on the marketed product stability program. These studies are conducted to assure that the product continues to meet the stability requirement for the approved expiration date. Therefore, these studies are conducted at the label storage conditions only. However, if new strengths, packages, or formulations are being developed, these studies would be conducted at accelerated storage conditions also.

2. Regulatory Guidances

Besides the guidances given to the industry by the compendia of the various countries or regions and the general requirements of good manufacturing practices (GMPs), there are organizations that set standards of practice, including stability, to standardize product development. The ICH (see Appendix) and the WHO^{4,5} have issued guidelines. The ICH guidelines are agreed-to practices by three marketing areas: Japan, Europe, and the United States. The WHO guidelines are for development of products worldwide. For ICH the stability guidelines are for climate zone II, whereas WHO lists guidelines for climate zones I, II, III, and IV.

Not only is it important to consult these guidelines for structuring your stability program, but it is also important to be aware of other additional specific requirements of the various governing agencies. For example, the FDA published a draft stability guidance document,² which included the ICH requirements and also defined and interpreted the ICH guidelines to include information they specifically require (e.g., site-specific stability).

3. Climate Zones

The derived climate zones for use in stability studies are given in Table 1. Reference to these zones and the derived storage conditions is discussed elsewhere.^{5,6} The ICH guidelines define zone II storage conditions, which will be used for the marketing areas of Japan, Europe, and United States.

4. Generic Products and Supplemental Products

Most of the discussion in this chapter applies to innovator products (new drug products containing active pharmaceutical ingredients that have not yet been approved for marketing) and in most cases a generic product manufacturer can follow these same practices. However, there are instances for which the governing regulatory agency may have some specific or slightly different requirement for these products. An example is a generic manufacturer of a product in the United States where the FDA has a different stability testing schedule than that of the ICH. This example is used to illustrate this difference in Section II.B.2.

For supplements to an existing product registered in a marketing area, the requirements can be different for the proposed change. Required stability information can range from no stability studies beyond the marketed stability program for a minor change (e.g., batch size) to a complete stability program for an extensive change (e.g., formula change). Required studies for changes

TABLE I Derived Storage Conditions⁵

Climate zone		Derived storage condition
I	Temperate	21 °C/45% RH
II	Mediterranean, subtropical	25 °C/60% RH
III	Hot, dry	30 °C/35% RH
IV	Hot, humid	30 °C/70% RH

made to an existing product are given in guidance documents such as SUPAC (see Appendix). Therefore, in the case of generic products and supplemental changes to existing products, it is important to consult the requirements of each local governing agency and their guidance documents.

B. Protocols

The protocol is a written document (see Section II.C.1) that describes the necessary parts of a stability study. It details the basic plan that will be executed, and its two major components include the tests to be performed and the schedule of testing that is planned. The types of batches that require a protocol are clinical, formulation development, registration, and marketed product. In addition, compatibility of a product with a vehicle (e.g., an injectable product in an intravenous saline solution) is often studied to support the use of injectable products for hospital use. Probe stability studies are generally more experimental in nature and may not be suitable for a formal written protocol.

The protocol describes for everyone what data are expected to be obtained to develop a stability profile of the product. It requires all the groups involved (formulator, analysts, and management) to understand what their roles are to support the study and assure successful completion of all important tasks. Therefore, the formulator will be able to determine the requirements of the batch being studied including the batch size, packaging required, and amount of documentation needed. The analyst will be able to assess whether the test methods he or she has are suitable or if additional development is needed. It also gives each person an understanding of what information is due to be collected to evaluate the stability of the product. A mechanism must also exist to allow modification of the protocol during the implementation phase to adjust for new requirements. A protocol amendment process is discussed in Section II.C.1.

Beside these two major sections, the protocol generally documents other information and procedures that will be in place to organize the study design and to assure that the proper product in its intended package configuration is studied. Certain information, standard for all studies, is written in standard operating procedures (SOPs) or is promulgated in government regulations such as the GMPs. These will be discussed later in this section. The protocol should also contain a signature section for the groups involved in the execution of the study, signifying that they agree with the design and that they intend to follow the plan as written.

I. Tests, Stability Criteria, and Methods

This section of the protocol is a list of the tests to be performed on the samples stored in the various environmental conditions. This list looks similar to the lists of tests found in the product specification. Indeed this is typically a subset of the specification. An example of a list of tests for stability is given in Table 2. The tests that monitor the quality, purity, potency, and identity, which could be expected to change based on the stability of the product, are chosen as stability tests. Therefore, appearance, assay, dissolution, and degradation products would be logical choices for these tests. However, the USP Heavy

TABLE 2 Tests for a Product in Tablet Form

Test	Stability criteria	Test method
1. Assay	90.0–110.0% of label	CT-prod#1-M1
2. Degradation products	Not more than 0.3% each	CT-prod#1-M2
3. Dissolution	Q = 80% in 45 min (USP acceptance criteria)	DM-prod#1-M3
4. Appearance	No significant difference from a control stored at 5 °C	Visual inspection

Metals Test is more of a “release” test and would not be used for stability. The stability criteria are the limits for each test, defining that a product is stable. Typically these are the same values as the specification limits for a product, but tighter limits may be used. The same holds true for the test methods because these are typically the same as the methods found in the specifications.

In the example found in Table 2, we have tests for a tablet product. Assay, dissolution, appearance, and degradation products are typical tests. For a moisture-sensitive product, there may be a need to test for moisture content as well. For a liquid product, a test for pH and microbiological tests are most often included. For a cream product the list of tests may also include a test for viscosity.

2. Stability Schedules

A stability schedule is a series of stability test intervals at which time all or some of the stability tests will be run on a sample in the study. There is also a group of stability environments that are used to study the product. The combination of results obtained for the various test intervals and environmental conditions creates a stability profile. Data from this profile are used to define the recommended storage conditions for the product and the expiration date that can be supported by the data. A typical ICH stability schedule¹ is found in Table 3.

The primary stability condition for a product to be stored at controlled room temperature is 25 °C/60% relative humidity (RH) for zone II. However,

TABLE 3 Typical ICH Schedule for Stability of a New Product

Environment	Intervals (months)
25 °C/60% RH ^a	3, 6, 9, 12, 18, 24, 36
30 °C/60% RH	6, 9, ^b 12 ^b
40 °C/75% ^c RH	1, 3, 6

^aZone II, 30 °C/35% RH for zone III, and 30 °C/70% RH for zone IV.

^bTest 9 and 12 months only if failure to meet specification at 40 °C/75% RH or assay is different from initial by greater than 5%.

^cFDA's generic schedule requires testing at 1, 2, and 3 months.

a stability program may also require environments for zones III or IV if the product is to be registered in countries located in those climate zones.

3. Stability Chambers

a. List of Environments

The environments at which stability samples have been studied have undergone a transition during the 1990s. With the guidelines from the ICH and the WHO, there has been a standardization using mean kinetic temperature and a common rationale for climate zones. The recommended storage conditions proposed in those guidelines are given in Table 4 along with the expected tolerance for temperature (typically $\pm 2^\circ\text{C}$) and humidity (typically $\pm 5\%$ RH). The guidelines discuss conditions for normal storage, refrigeration, and freezer storage. In addition to these standardized conditions, a typical stability program will have stress conditions that are used to learn about the degradation mechanisms of the product. Photostability testing of the drug substance and product is part of the stress testing studies of a stability program. In addition, the effects of cycle temperature between freeze and thaw or hot and cool temperature are discussed by the guidelines.

In addition to the storage conditions in Table 4, the ICH discusses the need for stress testing at higher temperatures. Both the ICH and the WHO recommend the study for liquids and semisolids dosage forms under temperature cycle conditions.

The FDA has proposed that low-humidity environments should be studied for various liquid products. Their most recent draft guidance² proposed $40^\circ\text{C}/15\%$ RH for accelerated, $30^\circ\text{C}/40\%$ RH for intermediate, and $25^\circ\text{C}/40\%$ RH for long-term storage conditions for liquid products.

For the environments in Table 4, the ICH provides guidance on the allowable excursions for temperature and humidity. They state that excursions exceeding the tolerances for more than 24 h should be documented, including a determination of the impact on the results of the study.

TABLE 4 Proposed Storage Guidelines

Storage condition	Tolerances	Testing zone	Guidelines ^a
25 °C/60% RH	$\pm 2^\circ\text{C}/\pm 5\%$ RH	Long term (II)	ICH, WHO
30 °C/60% RH	$\pm 2^\circ\text{C}/\pm 5\%$ RH	Intermediate	ICH, WHO
40 °C/75% RH	$\pm 2^\circ\text{C}/\pm 5\%$ RH	Accelerated	ICH, WHO
21 °C/45% RH	$\pm 2^\circ\text{C}$ and $\pm 5\%$ RH	Long term (I)	WHO
30 °C/35% RH	$\pm 2^\circ\text{C}$ and $\pm 5\%$ RH	Long term (III)	WHO
30 °C/70% RH	$\pm 2^\circ\text{C}$ and $\pm 5\%$ RH	Long term (IV)	WHO
2–8 °C	Not specified	Refrigeration	ICH, WHO
–5 to –20 °C	Not specified	Freezer	WHO
Below –18 °C	Not specified	Deep freezer	WHO
Light	1.2 million lux hours/200 watt hours (ultraviolet)	Stress	ICH

^aICH guidelines from reference 1; WHO guidelines from reference 5.

b. Qualification of Chambers

Chambers used in the formal stability program should go through qualification procedures. The chambers should be qualified at the time of purchase to assure a proper installation—the installation qualification (IQ). This procedure should document that the chamber has been installed properly and meets the manufacturer's specifications. The chamber should also be qualified to confirm that it is operating in a manner (i.e., parameters and tolerances) required for the stability studies. This operation qualification (OQ) should confirm that the chamber maintains the proper conditions of temperature, humidity, etc., within the specified tolerances. For temperature, this OQ would typically incorporate a “mapping” of the chambers to verify that the specified temperature is maintained throughout the chamber. For larger chambers with humidity control, multiple readings for humidity may also be needed. Finally, the continued performance of the chambers should be routinely monitored to address the performance qualification (PQ). The PQ would ideally be a continuous monitoring of the chamber to verify that the environment is within the specified tolerances. An automatic alarm system adds to the reliability of the monitoring system, especially during off-work hours. An important part of the OQ/PQ of the chambers is a routine maintenance program to inspect, test, and replace worn parts before their failure. In the authors' program, a semiannual schedule is maintained. A discussion of a proposal for IQ/OQ of stability chambers has been published.⁷

c. Inventory of Chambers

The stability system should be capable of maintaining an inventory of the samples in each chamber for all studies. This is usually handled by a computerized database system (alternately a logbook system can be used) that tracks the number of samples at all times. Following this procedure, it can be determined whether sufficient samples exist to complete or extend a study. For the purpose of extending studies, it is routine practice to store additional “backup” or “retain” samples at each storage condition for each study. The system should document the total number of samples and it should indicate the sample requirement at each testing interval. As samples are withdrawn from the chamber and used, the system should document this change in inventory. The inventory information is also useful if a chamber malfunctions, requiring the documentation of the occurrence for each study involved.

d. Documentation

Because the stability chambers are an integral part of the stability program and require continuous performance to specifications for long-term studies, all aspects of the chambers must be described in detail in an SOP. The SOP should include the procedures and the schedule for calibration of the chambers, the description and operating parameters, a routine maintenance schedule, inventory system, IQ/OQ procedures and a monitoring system (PQ), and emergency procedures for malfunctions or unusual occurrences.

e. Batch Selection

Depending on the point in the development process, a batch may be chosen for a variety of reasons. For a batch that is going to be used in clinical trials, stability data are required to support the clinical program. Formulation development batches are studied to gather data to select the market image for the product. During these early development phases of a product the guidelines provided from the agencies are usually less specific and the choices, therefore, are governed by the innovator. However, it is necessary to choose relevant batches and to document the reason for the choice.

For selecting the definitive registration batches for stability testing there are minimum requirements provided by the guidelines from the agencies. The ICH and WHO requirements are the following:

- Typically three batches of a formulation in each container–closure system are tested.
- Generally pilot- or production-scale batches are tested.
- The process used for all batches should be representative of the final process.
- Different lots of drug substances should be used, where possible.
- The container–closure system should be the same as what will be used for the market.
- Matrixing or bracketing of batches or packages may be allowed with justification. Bracketing assumes that an intermediate condition is represented by the batches being tested. Prior agreement with the agency is recommended.

As it pertains to batch selection, site-specific stability (SSS) has been the subject of a number of FDA conferences with industry. “Site-specific” means that stability batches are made at the proposed manufacturing site. The purpose of SSS testing is to assure that batches used for expiration date determination will be representative of the batches made for commerce. Although “site-specific” stability testing has been done for years, recently the discussion has centered around acquiring these data earlier in the product life cycle, i.e., in the new drug application (NDA). The current FDA requirement is that formal stability testing is not required in the NDA from the site of proposed manufacture as long as validation batches have been successfully produced at the site. These batches can be produced during the review cycle of the NDA and the data are added to the NDA as certificates of analysis. The validation report for the product made at the manufacturing site is reviewed by the FDA district office during the preapproval inspection (PAI). It is understood that, where possible, SSS data should be obtained early in the NDA process; however, this is not an absolute requirement.

f. Responsibilities, Evaluation, and Reports

The written protocol should not only contain information about the batches, packages, tests, specifications, and testing schedule, but also should indicate the responsibility of the study coordinator and the analytical testing laboratories involved, if it is not already defined in SOPs. The means of data tabulation and data evaluation, including the statistical analysis to be

used should be defined. The following responsibilities should be defined in the protocol if not documented elsewhere:

- Who will provide the samples and what amount is needed?
- How are the samples to be stored and in what environmental chambers?
- How much sample is to be delivered to the testing laboratories and at what interval?
- Who will approve/validate the test results?
- How will the data be reported?
- What are the projected expiration dates?

When this information is agreed to, the protocol document should be signed by the study coordinator and by the testing laboratory management, signifying agreement to complete the study as designed.

C. Documentation

I. Protocol and Protocol Amendments

The protocol is the written document that describes the studies to be conducted. The information contained in the protocol will be used to complete the stability report at the end of the study. The information to be included in the protocol is

- Reason for the stability tests and some background information
- Batch information (size, formula number, strength, drug substance supplier and lot number, date of manufacture, dosage form type, package, etc.)
- Package information (package material, component suppliers, and lot number)
- Initial sample identifier where the initial data can be found
- Tests and stability criteria (specification) to be used for evaluation
- Test schedule including the intervals to be tested for each environment
- Data analysis methods
- Specific reporting requirement, if appropriate
- Signatures of the study coordinator and testing group

At the time a study is begun, the protocol defines the procedures to be followed for successful completion. During the course of the study it may be necessary to modify the plan to meet new requirements. An amendment to the stability protocol can be used to formally change the plan during the conduction phase. This amendment must be agreed to between the study coordinator and the testing group and signed by both groups. The amendment must be written notification with the protocol number, studies that are affected, the proposed change requested, and the reason for the change. Each group signs and dates the amendment. An example is given in Figure 1.

Typical changes that would require an amendment are addition or deletion of a test or sample, rescheduling of a sample earlier or later, or any other change to the protocol that may affect the outcome or interpretation of the results. Minor changes allowed by SOPs may not require an amendment.

Exhibit 1: PROTOCOL AMENDMENT FORM

To: Stability Management Group

SUBJECT: STABILITY PROTOCOL AMENDMENT
MODIFICATION OF APPROVED PROTOCOL

PRODUCT: (Product name)

AMEND PROTOCOL: (Protocol number of protocol being changed)

STUDIES AFFECTED: (Give all study numbers affected)

REQUESTED CHANGE: (Items being changed in the protocol)

PURPOSE OF CHANGE: (Reason for change presented here)

APPROVED BY: _____

Study Coordinator	Date
-------------------	------

_____	_____
Stability Evaluation	Date

FIGURE 1 Protocol amendment form.

2. Deviation Report

In the course of doing product development work, there are instances in which it is not possible to follow the written procedures. This may happen in the manufacture of the batch, in use of an analytical method an SOP that needs to be revised, or for other possible reasons. Just as the protocol has an amendment mechanism to document changes to the plan, the use of a formal deviation report mechanism allows studies to be continued and any deviations to be documented with the reason and the appropriate corrective action, if needed. The report should list the deviation, why it occurred, who agreed to it, any corrective action plan, and signatures of the person initiating the report and management's agreement.

3. Out-of-Specification Reports

Any time samples are tested against specification, especially during stability studies for products under development, there is a chance that a sample may fail to meet specifications. This is especially true when samples are stored at accelerated conditions of temperature, humidity, and light. It is important to distinguish between results that are OOS because of instability versus those resulting from inappropriate samples, sampling error, or error in the analysis.

In the case of laboratory error or sample error, as defined by the *Barr* decision,⁸ there should be a formal mechanism for investigating these results. This investigation procedure should be defined in an SOP. This procedure can also be used to investigate out-of-trend results that look suspicious but are not OOS. This procedure should have the ability to evaluate the data collection procedures and, in the case of an error, identify the cause or likely cause of the error. The results of the investigation can be documented and included as a formal record in the stability study. It should prevent the studies from being

**OUT-OF-SPECIFICATION
INVESTIGATION REPORT**
Report No.: _____

Originator: _____ Department: _____
Date OOS Was Determined: _____ Date IR# Was Assigned: _____

- Material/Product
- Dosage Form & Strength
- Batch or Lot#
- Reason for Investigation
- Summary of Investigation
- Conclusion
- Effect on Other Batches
- Disposition Of Results
- Corrective Action
- Investigation Participants (Name and Department) (Date:)
- Notebooks, Laboratory Data Sheets, Other Supporting Document References*
- Originator's Signature _____ Date _____
- Departmental Approval _____ Date _____
- Quality Assurance Approval _____ Date _____

Figure 2 OOS investigation report.

affected by discarding data without just cause. The SOP also formalizes the procedures to be followed if a retest is required. In this case the following should be documented: the sample's results, a summary of the investigation with a conclusion, disposition of the results, and any corrective action required including any effect on other batches/samples. This investigation is approved and signed by the author, management, and a quality assurance representative. This report would be maintained as a record in the stability study. An example of an OOS report format is given in Figure 2.

If the data support the OOS result as being representative of the sample, it should be clear that the data are consistent with other stability findings. The use of historical data, mass balance considerations, or other changes in the sample should support the findings. This type of data evaluation is made easier by evaluating multiple studies in the stability program for a given product. For the stability report, the results of these studies and the interpretation of the results should be consistent with the stability of the product.

4. Test Results and Raw Data

Test results and the corresponding raw data must be maintained in an organized and legally defensible form. The use of notebooks or other "doc-

ument controlled” form is required. The modern laboratory and stability program have some form of laboratory information management system (LIMS) or database system to systematically collect and store the results of the stability studies. The stability database system should be password-protected with revision control features for data integrity and protection. The databases allow for uniform retention of data and a mechanism to assure that “required information” are captured and offers a tool for uniform formats for reporting of results.

These database systems must have a mechanism to “lock” the data in the system to prevent inadvertent or unauthorized changes being made. In the event that the data in the system would need to be revised, an authorization procedure should exist and the database system must have the capability to create an audit trail of the results. The audit trail is a means for retaining previous data that have been modified in a historical database. These historical data are maintained along with a record of why the change was made and who made the change. All of this information together makes up the audit trail.

5. Stability Report

The culmination of the conduction of the stability plan design in the protocol and the data generated from the stability studies is the stability report. This may be a formal document or a similar presentation of the study plan and results in a regulatory submission. The report presents the data evaluation and the conclusions of expiration date and storage requirements.

A stability report is written to document expiration dates and a storage statement for the registration batches for the formal stability studies. It is also used to document the expiration date for formulations that are being used in the clinic. In this case, the expiration date is generally a date when the product should be discontinued or that additional data are required to extend the expiration date. A more detailed discussion of the information included in the stability report is given in Section II.E.

D. Schedules

Once a stability study is initiated, the schedule of sample testing is set for a period of about 2–5 years. This presents a significant challenge to the testing laboratory to manage and track the work scheduled.

I. Planning and Workload

The tracking of samples and their schedule test dates is easily handled with a modern computer system scheduler. With the computerized scheduling system in place, the workload can be organized on a daily, weekly, or monthly basis. Each sample should be identified with the methods to be used. A key factor for planning is to be able to look ahead for the required period of time to identify the resources needed so that adjustments can be implemented to cover the scheduled workload.

A few alternatives to scheduling the work are possible. All samples can be taken based on their pull date and the samples remain in the laboratories

for testing. The SOP would indicate the maximum time allowed for testing. Alternately, based on the schedule of samples, the laboratory can choose when a sample should be tested based on limitations given in an SOP. In the authors' laboratory, the laboratory personnel request the samples within certain time restrictions. In doing so the laboratory personnel are aware of the schedule of samples and request samples based on their ability to complete the analysis. The use of contract testing laboratories has aided in the administering of the stability system to handle high-demand periods.

2. Turnaround Time

The time to complete the stability tests relative to the schedule date depends on the workload of the laboratory. As previously discussed, the more control the laboratory is given for timing the receipt of the samples for testing in the laboratory, the greater the likelihood that the results will be available in a reasonable period of time. Currently, in the authors' laboratory, the samples are requested by the analysts within defined time limits and the results are available within a week of this request. The maximum time between the scheduled date and the actual assay date is 1 month or less. Procedures and time limitations need to be defined to maintain a reasonable stability program. In the authors' laboratory the time between schedule date and pull date depends on the age of the sample. Sample analyses are scheduled at a weekly meeting of the analysts and the stability staff that manages the sample storage. The laboratory supervisor leads the meeting, and samples are scheduled to begin analysis within 3 days for weekly samples, 1 week for monthly samples, and 2 weeks for quarterly or longer time points. The actual date of the analysis is recorded with the stability data in the LIMS.

E. Stability Reports

The objective for a stability program is to determine the expiration date of the product in its respective package(s). It is also to determine the proposed storage statement recommended for the product for it to continue to meet all the requirements of quality, purity, strength, and safety in the marketplace. The label storage statement must include storage precautions, if appropriate, for the pharmacists and the patients.

In each case the report includes a summary of the design given in the protocol, the tests and procedures used in the studies with the appropriate limits for evaluation, the stability data tables with the necessary batch documentation, and finally the discussion of results and conclusions.

I. Background Information

The stability data tables generated for the stability studies are only a part of the documentation required for a stability program. The report should begin by describing the objectives of the studies, a discussion of the batches including their formulation and the site of manufacture, the package description and packager, the test methods and the stability criteria, and the testing schedule including future planned test intervals. This information defines the manufacturing and packaging processes that the data represent. Without it, the

stability studies would be incomplete. A summary of this information (product, strength, batch, formula number, drug substance supplier, package, date of manufacture, manufacturing site, and date on stability) should be included in the stability data tables, reported below.

2. Data Tables

The stability data table is the means for reporting the results of the stability study in a concise format for ease of review and interpretation. An example of a data table is given in Figure 3. The table consists of a summary of the important batch and manufacturing information, as well as the test data and method references. The example given has the data grouped by storage condition and then by time interval to present the stability as a function of time for each environment studied. With the data from the different methods listed in columns across the table, any apparent connection between multiple stability results for a sample can be easily made and interpreted (e.g., a decrease in assay and an increase in degradation products). Each study should be included in a separate table and, in some instances, multiple tables (one table per storage condition) may be used.

3. Evaluation and Conclusions

The data from each test should be evaluated and discussed. Any indications of instability should be noted with a discussion of the cause of the change and the effect on the product's performance. Correlation to previous chemical stability data (e.g., degradation in the drug product related to the drug substance) should be noted to differentiate between the inherent stability of the drug substance versus a formulation-related stability or instability.¹ The results of the statistical analysis, where appropriate,¹ and the analysis of impurities [see Appendix, Q3A(R) and 3QB(R)] should also be discussed. The effect of the stability data on the expiration date and recommendations for the storage statement should also be presented and be consistent with stability guidance documents relevant to the appropriate regulatory agency¹⁻⁵ (see also Appendix, Q1B and Q1C).

Study Name: _____	Date on Stability: _____
Formula Number: _____	Protocol Number: _____
Lot/Batch No.: _____	Manufacturer: _____
Product Name: _____	Manufacturing Site: _____
Package Description: _____	Date of Manufacture: _____
Strength/Concentration: _____	Batch Size: _____
Drug Substance Lot No.: _____	

Specifications	Pass	90-110%	Q=75% @ 30min	NMT 0.1%	NMT 0.2%	Pass	
Storage	Interval	Appearance	Assay	Dissolution	Impurity 1	Impurity x	Color
	Initial	Pass	99.9%	Mean=83%	ND	ND	Pass
25C/60%	3M	Pass	99.5%	Mean=84%	ND	<0.1%	Pass

Table continues for all storage conditions and intervals.
 Impurities are list for each or for totals.
 The tests listed here are for example of a data table format.

FIGURE 3 Data table. ND, none detected; NMT, not more than.

F. Audits and Inspections

Audits by a quality unit within the organization are routine checks of the stability program and include verification of the data collected for the studies presented in reports.⁴ In addition, the regulatory agencies will do inspections (PAI) of programs and facilities for a specific product or as a routine inspection of a facility (general GMP inspection).

1. Internal Audits of Data and Programs

The stability program should be audited by the company's quality unit on a periodic basis. In the authors' laboratory, the stability data are audited quarterly by the quality assurance unit. The equipment, processes, and procedures that support the stability program are a part of this audit to verify that appropriate systems exist and are being followed. The SOPs are reviewed, the activities and facilities are observed, the data are audited, and an audit report is issued. At the time a stability report is written, the data in the report are audited against the raw data obtained from the laboratories and an audit report is issued. These audit reports are used to provide an objective view of the stability program and data against the current regulations to assist management in the improvement of the program. This audit further increases the probability of a successful inspection from a regulatory agency, such as a PAI.

2. Inspections (Preapproval and Facility Inspections)

PAIs are inspections of products that are under regulatory review. These are scheduled by the regulatory agency during the review process to determine the accuracy of the data and the acceptability of the facilities and procedures used to collect the data. Agencies such as the FDA and the Medicines Control Agency have programs for initiating these inspections. The stability data, as an important part of a regulatory submission of a product, are often an area of focus during these inspections.

Specifically in a PAI, a subset of the stability data is often reviewed by the regulatory agent to verify the results, to monitor the manufacturing records for the batch, and to review the methods used to collect the analytical test data and the systems used to control manufacturing and testing.

General inspections of facilities are also conducted on a routine basis by regulatory agencies, generally every 2 years or sooner. These inspections are to determine general adherence to GMPs and to identify any product problems being experienced by the facility being inspected. Included in the inspection are checks to determine if appropriate systems are in place to effectively produce and control the manufacture of the products. Often a check of the stability system and the product data are reviewed. Therefore, it is critical for the stability program to have a set of SOPs to follow that adequately control the stability process.

III. EXCIPIENTS

A. Formulation Development

Excipients are pharmaceutical ingredients that are used in product formulations. Each serves a specific purpose (i.e., binder, disintegrant, or pH adjustment) for the proper performance of the dosage form.⁹ Most of the excipients used in product formulations are compendial items [United States Pharmacopeia (USP), European Pharmacopeia (EP), etc.], and therefore, they are widely used and understood and there is usually no requirement to perform stability tests for them. Many are also used in the food industry. In addition, since the excipient's function in the product is not directly linked to efficacy, its need for tight stability control is less critical. For these two reasons, it is seldom necessary to organize a formal stability program or database for excipients.

B. Stability of New Excipients

For new excipients that are not listed in a compendia there may be a need to generate stability data even though there is no formal stability requirement. New excipients need to be handled on a case-by-case basis. An excipient that is a physical modification of a compendial item but does not meet all of the compendial tests is a case for which stability data would not be needed. An example could be a component that has been physically modified (e.g., milled), but not chemically changed, or an excipient that is a mixture of compendial items to form a "new" excipient. These typically should not require generation of a stability database.

For a totally new chemical to be used as an excipient, one that has never been used in a drug product, stability data may be needed to support its use. In this case a stability program similar to that for a drug substance (see Section IV) could be designed and a stability profile collected. The use of excipients is ultimately the responsibility of the drug product manufacturer. However, sufficient characterization of the excipient, which may include stability data, are typically generated by the manufacturer of the excipient and documented in their drug master file. This type of excipient may require toxicology data to support its use. The USP 24–NF 19⁹ has a guideline, USP < 1074 >, that addresses biological safety evaluation for new pharmaceutical excipients. A general discussion on requirements for "pharmaceutical excipients" was included in a WHO publication.⁴

C. Probe Stability

It is important to have a good understanding of the excipients used in a formulation to assure proper performance and facilitate the interpretation of stability data generated on the product. The following section will give a few selected examples of stability of excipients that can be used to aid in their selection or to evaluate the stability data of drug products that contain them. For these reasons, a probe stability study may be useful to obtain data to distinguish whether a stability observation for the drug product is due to the excipient

or to the drug substance. As described earlier, a probe study is a short-term, accelerated study to gain insight for evaluating later stability studies. In these cases a probe stability study would be helpful unless similar information can be obtained from the literature, the excipient supplier, or prior experience.

D. Examples of Excipient Stability Information

The following four examples are presented to illustrate the importance of understanding the properties of excipients and their stability. This information can be important to the quality of the pharmaceutical products in which they are used. This information aids in the selection of the right excipient for the product and helps in evaluation of the stability data for the final product.

The parabens are a class of 4-hydroxybenzoic acid esters (primarily methyl, ethyl, propyl, and butyl esters) that are used as biological preservatives in liquid and semisolid dosage forms. Another preservative often used is benzyl alcohol. Parabens and benzyl alcohol are compendial items used extensively in the pharmaceutical industry. These materials are very stable compounds, but in the presence of water the paraben esters will hydrolyze to form 4-hydroxybenzoic acid and the corresponding alcohol. Likewise, benzyl alcohol can easily oxidize in a formulation to form benzaldehyde and benzoic acid. These reactions occur slowly for the unformulated material but can proceed more quickly in a formulation. It is important to know that these reactions do occur in the drug product and that we can distinguish the excipient degradation product from the active ingredient and its degradation products. Knowing that the hydrolysis of the parabens is catalyzed in acid can also help the formulation group select an appropriate pH for a product.

Long-chain unsaturated oils such as fatty acid esters are used in a number of semisolid and liquid products. It is known from the use of these oils that the double bonds in their chemical structure can react with oxygen to form peroxides and/or hydroperoxides. Some compendial monographs for these materials will have specifications to limit the level of peroxide for this reason. For active ingredients that are easily oxidized, these excipients may need to be avoided to minimize the catalytic oxidation of the active ingredient and to maximize the stability of the drug product.

It has been observed that FD&C Blue #2 (indigo carmine¹⁰) dye can oxidize to cause its color to fade. In a formulation it can react to form a green (mixture of blue and yellow) product. Therefore, a light blue tablet can go from its blue color to a greenish blue. However, at higher concentrations of the blue dye, this change may not be evident due to greater amounts of the original blue color. Therefore, it can be important to select the proper dye or concentration to minimize a possible change in color.

E. Stability of Excipients—Bound and “Unbound” Water

A special consideration for a formulation and its stability is the effect of water. Carstensen¹¹ provides a good discussion of the effect of water on solid dosage forms. The effect of water can be a problem in a formulation when the active ingredient is moisture sensitive. When water affects the formulation and causes

instability in the product, water levels should be controlled or an excipient that minimizes the association of water should be chosen. A specific example is the difference between tightly bound water (e.g., water is held in the crystal lattice) and water that is adsorbed to an excipient by “weak” hydrogen bonds. For an active ingredient that degrades by hydrolysis or is catalyzed by water, an excipient that has loosely bonded moisture will promote degradation while water of hydration in the crystal structure or an anhydrous excipient will not facilitate degradation. Excipients with water held by hydrogen bonds tend to adsorb moisture easily, and this water is usually more readily available for hydrolysis. An example of a crystal hydrate is the hydrated form of lactose, whereas microcrystalline cellulose tends to have “loosely” adsorbed moisture.

F. Conclusion

Excipient stability studies are generally not required to support the use of these materials. These materials have compendial standards and are suitable for their intended use. It is important, however, to understand the chemistry of the excipients so that the proper excipient can be used in a product.

IV. DRUG SUBSTANCE

Information on the stability of the drug substance is fundamental to the entire drug development process. Although there are examples of the instability of a drug substance being improved by proper formulating and packaging, the inherent stability of the drug substance will ultimately influence the design and expiration date of the commercial product. As a result, regulatory agencies expect stability data on the pure drug substance to be part of any new drug application.

A. Developmental Stability Testing

The foundation of any viable stability program for a drug product begins with a thorough understanding of the chemistry of the drug substance. Information on the mechanism(s) of degradation is essential to understanding how the drug substance will behave under various environmental changes and conditions. This information is usually determined by conducting stress degradation studies under varying conditions of acidity, basicity, light, heat, and oxidation. Other conditions may be chosen depending upon the particular drug substance being studied. From these stress studies, knowledge of the inherent stability and mechanisms of degradation can be obtained. The propensity of the drug substance to preferentially degrade under specific conditions will be areas to which particular attention will have to be paid in the storage and formulation of the drug product. If the drug substance is prone to hydrolysis, the effect of humidity on storage will necessarily be a focal point in the stability protocol.

Whereas the stress conditions will usually be more severe than the drug substance will experience under normal conditions, the distribution of degradation products that is obtained can be used to predict the exact degradation

pathway(s) to be expected at each environmental condition. Identification of the degradation products at this stage is invaluable in establishing the degradation pathway. Although degradation pathways under stress conditions are usually much more complex than those at room temperature, the mass distribution of the degradation products may be an indicator of which degradation products will be seen on long-term storage. The ability to separate all of the degradation products will also be important for developing and validating the stability-indicating properties of any proposed analytical methods. With an understanding of the degradation chemistry, specifications can be established that will ensure that the drug substance will retain its identity, quality, purity, and potency over its expected shelf life when properly stored.

The recently published ICH Guideline on “Stability Testing of New Drug Substances and Products”¹ suggests that for stress testing of temperature effects, 10 °C increments at accelerated temperatures (50 °C, 60 °C, etc.) should be studied. If appropriate, humidity conditions above 75% RH should also be studied. The effect of pH on the drug substance’s susceptibility to hydrolysis should be studied across a wide pH range, in solution or suspension. Photostability stress testing should be performed in accordance with the conditions specified in ICH Q1B (see Appendix). Oxidative stress should always be included in any assessment of degradation pathways.

The regulatory agencies recognize that the synthesis scheme, the specifications, and the test methods will evolve as the drug development process continues through the various clinical phases. As the database of knowledge about the drug substance increases, the stability data requirements also change as the clinical phase changes. In early phase I studies, stability data to support the toxicological studies and proposed clinical studies must be collected. Enough stability data should be collected to demonstrate that the drug substance remained intact during the course of the toxicological and phase I clinical trials. Depending upon the stability of the drug substance, impurities that increased during storage may be qualified by reference to these early human and animal studies. In phase II, the stability studies should support the investigational formulations used in the clinical trials to aid in selection of the final formulation, container, and closure system.

The information obtained from the stress studies and the phase I and II studies should be reflected in the protocol for the primary stability studies to support the final phase III clinical trials.

B. Batch Selection

Because drug substance stability data are needed to support the three clinical phases, the selection of batches at each phase will reflect the synthetic scheme and batch size used at that stage of development. In early phase I studies, the batches used in the toxicological and clinical trials should be monitored. As the synthetic scheme and batch size change, batches made by the new synthetic process should also be selected for stability testing and monitored through the phase II clinical trials. Knowledge about the drug substance learned in phases I and II should be the basis for the stability protocol for the drug substance

manufactured by the final synthesis process that will be used to support the phase III clinical trials and the primary drug substance registration studies.

Stability data for registration from at least three batches of drug substance from accelerated and long-term storage are expected by the various regulatory agencies. Long-term testing data should include information from a minimum of 12 months of storage for the three batches. The batches for pilot scale should, at a minimum, be manufactured by the same synthetic route and use a method that simulates the final process to be used on a production scale. The quality of the batches tested for stability should be representative of the batches used in preclinical and clinical studies or of a better quality. They should also be representative of batches expected from the future commercial drug substance manufacturing scale. The batches selected for stability testing should also be packaged in containers with closure systems that are representative of the packaging to be used on the manufacturing scale. Data from laboratory scale batches may be submitted as supportive data.

The first three production batches of drug substance manufactured after approval, if not a part of the original submission, should be selected for long-term stability testing using the same stability protocol submitted in the approved drug application.

C. Specifications and Test Methods

The properties of the drug substance that influence quality and safety/efficacy should be the focus of the stability protocol. Before initiation of the primary stability studies it is not unusual for the specifications and test methods to evolve as the synthetic route changes, manufacturing scales change, impurity profiles change, and so on. By the time the primary stability studies begin, the specifications and test methods should be finalized so that as testing occurs over time the key properties of the drug substance can be monitored for significant changes from the established limits. The specifications should include, where appropriate, physical, chemical, biological, and microbiological properties. The established limits should be numerical values, ranges where possible, or other criteria for individual tests. The test methods used to measure the various properties should be validated to show that they accurately and reproducibly detect and measure any changes that might occur over the lifetime of the stability protocol.

In the ICH guideline on “Chemical Substances” (Q6A, see Appendix), drug substance tests are classified into two categories, universal tests and specific tests. In the universal test category, there are tests for description, identification, assay, and impurities. These tests are generally applicable to all new drug substances. The description test should make a qualitative statement about the physical state and color of the new drug substance. The identification test should be able to distinguish between closely related compounds. Normally, infrared (IR) spectroscopy is used. Use of a single chromatographic system is not generally acceptable, but the use of two chromatographic systems using different principles, such as thin-layer chromatography (TLC) and high-performance liquid chromatography (HPLC), or a combination of a chromatographic system and another technique, such as HPLC/mass spectrometry,

is generally acceptable. If the new drug substance is a salt, an identity test for the specific ion is required. A specific, stability-indicating assay is recommended for determining the content of the drug substance. Although HPLC is the most common technique used for assay, a combination of a nonspecific assay, for example, a nonaqueous titration, and a method for impurities, such as TLC, may also be justifiable. Impurity tests for inorganic, organic, and residual solvents usually use chromatographic techniques, such as TLC, HPLC, and gas-liquid chromatography. Generally, the tests for content and for organic impurities are combined in one chromatographic test.

In the specific test category, there are tests for physicochemical properties, particle size, polymorphic forms, chirality, water content, inorganic impurities, and microbial limits. These tests should be used when the specific attribute can have an impact on the quality of the drug substance. Physicochemical tests include pH, melting point/range, and refractive index. Particle size testing is an important test for solid and suspension-type formulations. The effect of particle size on dissolution, bioavailability, and stability cannot be overemphasized. Methods to determine particle size include the Coulter method, laser-light scattering, microscopy with image analysis, and time-domain analysis. Drug substances can also exist in different polymorphic forms that have different properties. Polymorphism may also include hydrates, solvates, and amorphous forms. The differences in the properties of the various polymorphic forms can also have a significant impact on the quality of the finished product, its bioavailability, and its stability. As a result, the correct solid-state form must be specified. Common techniques to differentiate between forms include solid-state IR and nuclear magnetic resonance (NMR), melting point (including hot-stage microscopy), X-ray powder diffraction, thermal methods (differential scanning calorimetry, thermogravimetric analysis, and differential thermoanalysis), optical microscopy, and Raman spectrophotometry.

When the drug substance is hygroscopic, susceptible to hydrolytic degradation, or exists as a stoichiometric hydrate, testing for its water content will be required. The common methods for measuring water content are loss on drying and Karl Fischer titration. Karl Fischer titration is generally preferred as the method for specific water analysis but can be subject to interference by certain types of compounds. If tests for inorganic impurities are required, for example, from a catalyst, compendial tests for heavy metals or sulfated ash may be used or other techniques, such as atomic absorption spectroscopy, may be required for the analysis.

For chiral drug substances being developed as a single enantiomer, control of the other enantiomer is required. An enantioselective test method should be used to test the drug substance. The combination of an achiral method and an appropriate method for controlling enantiometric purity is also acceptable. An achiral method may also be acceptable when the drug chemistry degradation studies have shown that racemization is not a significant degradation pathway. Tests for microbial limits may also have to be considered, depending upon the nature of the drug substance, its method of manufacture, and its intended use. Sterility testing may be appropriate for drug substances that will be used in sterile products. Endotoxin testing may be needed for drug substances intended for injectable products. Testing for the total count of aerobic microorganisms,

yeasts, and molds and the absence of specific objectionable bacteria, such as *Staphylococcus aureus*, *Escherichia coli*, *Salmonella*, and *Pseudomonas aeruginosa*, may also be required. The tests described in the various compendia are generally used.

For detailed information on establishing specifications and test methods, interested readers are referred to the ICH guidelines on specifications (Q6A, see Appendix) and on method validation (Q2A, see Appendix).

D. Storage Conditions

As a general principal, a drug substance should be investigated for stability under storage conditions that reflect the temperature, humidity, and length of storage in the areas of the world where the drug product will be manufactured, shipped, and marketed. The long-term storage conditions studied will generally be reflected in the labeling.

Before the ICH was formed, agreement on the appropriate storage conditions for stability studies was always controversial. The regulatory agencies in different countries did not always agree with each other. For example, the definition of room temperature or controlled room temperature was different globally. Currently, the world is divided into four climatic zones based on the mean kinetic temperature. The definition of room temperature in the four zones is given in Table 5 as is the relative humidity. Some of the countries that fall into these zones are also shown.

Long-term testing should last a minimum of 12 months at the time of submission and should be continued through the proposed expiration date. Additional data collected while the submission is under review may be submitted with the agreement of the regulatory agency. Data from accelerated storage

TABLE 5 International Climatic Zones

	Climatic zone	°C	%RH
I.	<i>Temperate</i> United Kingdom Northern Europe Canada Russia	21	45
II.	<i>Mediterranean, subtropical</i> United States Japan Southern Europe (Portugal, Greece)	25	60
III.	<i>Hot, dry</i> Iran Iraq Sudan	30	35
IV.	<i>Hot, humid</i> Brazil Ghana Indonesia Nicaragua Philippines	30	70

TABLE 6 General Drug Substance Storage Conditions

Study	Storage condition	Minimum submission interval
Long-term	25 ± 2 °C/60 ± 5% RH	12 mo
Intermediate	30 ± 2 °C/60 ± 5% RH	6 mo
Accelerated	40 ± 2 °C/75 ± 5% RH	6 mo

conditions (Tables 6–8) should also be part of the submission to support the long-term data and to simulate any short-term temperature and humidity excursions that the drug substance may experience during shipment or storage that go beyond the label conditions.

Other conditions may be used but must be justified. Agreement with the regulatory agencies before initiation of studies at other conditions is highly recommended.

For a drug substance a significant failure is defined by the ICH as a failure to meet specification. This definition of significant failure is the reason that specifications are established before the primary stability studies are started, so that the criteria for comparison are clearly identified. If a significant failure occurs in the first 6 months at the accelerated condition, at least 6 months of data at the intermediate storage condition from a 12-month study must be included in the original submission. In the authors' laboratory the 6-month 30 °C/60% RH intermediate storage samples are routinely tested along with the 6-month 40 °C/75% RH and 25 °C/60% RH samples. If a significant failure occurs at 40 °C/75% RH, the 30 °C/60% RH data are immediately available for evaluation and 9- and 12-month samples are scheduled to complete the study at 30 °C/60% RH. Even if a significant failure has not occurred, the additional data help support the long-term data.

If a significant failure occurs within the first 3 months at 40 °C/75% RH, the proposed re-test date should be based on the real-time long-term data. In addition, if a failure does occur within the first 3 months, data will have to be presented to allow use of the drug substance if any excursions occur outside of the proposed labeling.

For drug substances requiring freezer storage, the re-test date is based on the real-time long-term storage data. To cover excursions beyond the labeling, short-term testing on one batch of drug substance at 5 °C or at 25 °C/60% RH is suggested. Drug substances requiring storage below –20 °C should be considered on a case-by-case basis.

TABLE 7 Drug Substances Requiring Refrigeration

Study	Storage condition	Minimum submission interval
Long-term	5 ± 3 °C	12 mo
Accelerated	25 ± 2 °C/60 ± 5% RH	6 mo

TABLE 8 Drug Substances Requiring Storage in a Freezer

Study	Storage condition	Minimum submission interval
Long-term	$-20 \pm 5^{\circ}\text{C}$	12 mo

E. Testing Frequency

Testing should be conducted often enough to define the stability characteristics of the drug substance relative to the proposed specifications. The ICH¹ recommendations are

- For a 12-month re-test date, the drug substance long-term samples should be tested every 3 months for the 1st year, every 6 months for the 2nd year and then annually.
- For accelerated storage conditions, a minimum of three test points including the initial and end points (e.g., 0, 3, and 6 months) should be obtained.
- For intermediate storage conditions, a minimum of four test points including the initial and end points (e.g., 0, 6, 9, and 12 months) should be obtained.

If the accelerated stability data show a trend toward a significant failure, the test protocol should be amended to include more frequent testing to determine the time period where the actual failure occurs.

F. Stability Commitments

The magnitude of the stability database included in the submission influences the stability commitment that must be made.

- If the submission includes long-term storage data on three production batches through the proposed re-test period, no postapproval commitment is needed. Even though no further commitment is required, it is recommended that one production-sized batch be selected for stability testing annually to monitor stability of future batches over time.
- If the submission does not include long-term storage data on the primary batches through the proposed re-test date, the studies should be continued through the postapproval phase to establish the re-test period.

In the latter case, several options are available:

1. If the submission includes stability data on at least three production batches, a commitment to continue testing through the proposed re-test period must be made.
2. If the submission includes stability data on less than three production batches, a commitment to continue testing through the proposed re-test period must be made and additional production batches to total at least three must be selected for stability testing and tested through the proposed re-test period.

3. If the submission does not include stability data on any production batches, a commitment to select the first three production batches for long-term stability testing and to continue testing through the proposed re-test period must be made.

The same stability protocol used for the primary batches must be used for the stability commitment unless scientifically justified otherwise. In this case prior agreement with the regulatory agencies is recommended.

G. Data Evaluation

The ultimate goal of the stability study is to establish the re-test period that will be applied to all future drug substance lots manufactured in a similar manner with the proposed process. The re-test period will be established using a minimum of three lots by assessing the stability information collected on the drug substance's physical, chemical, biological, and microbiological properties as a function of time, temperature, humidity, and light. The degree of certainty that the stability of a specific future lot of drug substance will remain within specifications until the next re-test period is influenced by the variability of the lots used in the stability studies.

Studies that show virtually no degradation or variability will usually not require any formal statistical analysis. Under these circumstances the requested re-test period is normally granted when a complete justification for not needing a statistical analysis is part of the submission. The analysis should include all appropriate properties of the drug substance.

The evaluation of the data should begin with an examination of the individual data points that have been collected over the course of the stability study. In a normal data set, some variability will always be seen. The variability can arise from variability in the product, the method, and the analysts carrying out the testing. The specifications for drug substance assay range generally from 98.0 to 102.0% on the anhydrous basis. If the result must be calculated on the anhydrous basis, the variability in the water assay will also influence the results. Thus, over the course of the stability study, the individual data points will most likely increase and decrease within the specification range. One question to consider is, can the variability in the data be explained by the expected variability of the determination? The data points for individual impurities and total impurities should be examined as the study continues, to see if the specification limits are being approached and if a failure is imminent. A comparison to the impurity levels in the preclinical studies and clinical trials should be made to be sure that the levels of impurities being seen in the stability study have been qualified in animal or clinical trials. Any unknown peaks in the chromatograms will have to be investigated and discussed in the submission. For polymorphic drug substances, the data must be carefully evaluated to see if a change in crystal form is occurring. This change may be very subtle, and a trained spectroscopist may have to analyze the data to detect it. On examining all of the data, do all of the individual data points stay within specification or are some OOS? If some are OOS, they will have to be investigated and documented. When an OOS result is obtained, the data should be

investigated immediately for an assignable cause. A delay in investigating may prevent finding the correct cause. If the cause can be ascertained quickly, the same sample may then be re-tested and the correct result reported. It is strongly recommended that the data be evaluated as they are being collected and not when the study is completed or at the time of the submission. Waiting until the end may make it impossible to resolve or explain anomalous data points.

The normal and acceptable statistical approach for analyzing quantitative properties that change over time is to calculate the time it takes for the 95% one-sided confidence limit for the mean degradation curve to intersect the acceptable specification limit. If the data show that batch-to-batch variability is small, it may be worthwhile to combine the data into one overall estimate. This can be done by first applying the appropriate statistical tests to the slopes of the regression lines and zero time intercepts for the individual batches. If the data from the individual batches cannot be combined, the shortest time interval any batch remains within acceptable limits may determine the overall re-test period.

Extrapolation of the real-time data from the long-term stability condition to support a re-test period longer than the real-time data can be proposed. The proposal should be supported by the accelerated data, by knowledge of the degradation mechanism, by additional stability data from batches other than the primary batches that might be available, and the goodness of fit of the mathematical model used in the statistical analysis.

It is strongly recommended that the drug substance sponsor and the reviewers confer and agree on the adequacy of the proposed stability protocol before implementation so that both parties know what is expected and what will be submitted, thus avoiding any unnecessary delays in approval because of stability.

V. DRUG PRODUCT

One important property of a pharmaceutical product is its stability over time. In the pharmaceutical industry, manufacturers are expected to conduct appropriate stability studies in the container and closure systems in which the products will be marketed. The objective of stability studies is to provide evidence on how the quality of the formulated product varies with time under the influence of a variety of environmental factors such as temperature, humidity, and light and enables recommended storage condition, re-test period, and shelf life to be established. The ICH developed several guidelines covering regulatory requirements concerning efficacy, quality, and safety aspects of the finished drug product. The following ICH guidelines set out the stability requirements for a registration application within the European Union, Japan, and the United States: (1) "Stability Testing of New Drugs and Products" [Q1A(R)],¹ (2) "Photostability Testing" (Q1B, see Appendix), and (3) "Stability Testing for New Dosage Forms" (Q1C, see Appendix). The date of implementation was January 1, 1998. The WHO^{4,5} also established a separate parent guideline on stability testing to cover countries in all climate zones. In June 1998, the FDA issued a draft guideline on Stability Testing of Drug Substances and

Products.² The guideline is intended to be a comprehensive document that provides information on all aspect of stability data generation and use. It provides recommendations regarding design, conduct, and use of stability studies that should be performed to support investigational new drug applications, new drug applications, abbreviated new drug applications, new dosage forms, supplements and annual reports, and license applications for biologics, and product license application. In April, 2000, FDA published a draft revised guidance entitled “Q1A(R) Stability Testing of New Drug Substances and Products.”¹² Some of the types of changes in the formulated products that may need to be monitored during stability studies are physical description, clarity of solution, absence of particulates, color, odor, taste, hardness, friability, disintegration, dissolution, weight change, moisture content, particle size, pH, package integrity, degradation product formation, interaction of package component with the formulated product, loss of preservative, maintenance of sterility, and proliferation of microorganisms in nonsterile products. In designing stability programs, all of these aspects should be considered to choose the proper list of test procedures.

A. Stability Testing During Drug Development—Phases I, II and III

Stability data are required in all phases of drug development to demonstrate that the formulated products are within acceptable chemical and physical limits for the planned duration of the proposed clinical investigation. Sufficient information should be available to ensure the proper identification, quality, purity, and strength of the investigational formulated products. The amount of information needed to achieve that assurance will vary with the phase of the investigation. If a very short-term clinical trial is proposed, the supporting stability data can be correspondingly very limited. All stability data should be generated under good laboratory practice and/or GMP conditions.

1. Phase I Studies

Studies to support the stability of the formulated product during the toxicologic investigations and the proposed clinical trials are conducted in the proposed container/closure system at the recommended storage conditions. Although detailed stability data need not to be submitted to the regulatory agency before a clinical study, data must be available to ensure the quality, purity, and strength of the product. In phase I, the testing frequency, storage conditions, and storage periods indicated in the ICH guideline need not be followed.

2. Phase II Studies

Information on the stability of the finished product is collected in the proposed container/closure system to support the phase II clinical studies. At this stage of development, protocol-driven stability studies are initiated and the conditions indicated in the ICH guideline¹ are recommended. The test frequency is every 3 months in the 1st year and every 6 months in the 2nd year. The storage conditions recommended in the ICH guideline such as room temperature (25 °C/60% RH), light (1.2 million lux hours), and heat/humidity

(40 °C/75% RH) are followed. In phase II, the expiration date of the formulated product is estimated and provided to support the clinical investigation. Expiration date is based on the on-going phase II stability studies, the phase I stability studies, and the data generated for the drug substance. The expiration dating varies based on the stability of the drug substance and its formulated product. For example, a drug substance is stable and no degradation has been found under the stress conditions. In addition, no degradation has been found in the phase I stability studies. Although the phase II formulated product is different from that of phase I, with limited phase II stability data, expiration dating can be extended beyond the available stability data of the phase II product, based on the phase I experience. Typically, the 3-month stability data can be used to estimate and provide expiration dating of 9–12 months for the formulated product.

If an active comparator is used in the clinical trial, a stability investigation of the comparator is also conducted. The formulated comparator is packaged in packaging that typically is different from the commercial packaging, and then selected for stability testing. The storage period in the stability investigation covers the duration of the clinical trial. The test frequency for the active comparator may be less frequent than that recommended in the ICH guideline, based on the commercial expiration date.

Furthermore, additional stability investigations are conducted to develop a final formulation, such as compatibility studies for potential interactive effects between the drug substance and the excipients of the formulation and selection of the most appropriate container and closure systems. Typically, these investigations (probe stability) are conducted under extreme conditions and a very short period of time, such as 80 °C or 1000 foot-candles of light for less than 3 months. The data generated at this stage are part of the drug development procedure and are used to select excipients, primary package component, and storage conditions for the formulated product.

3. Phase III Studies

During phase III studies, the emphasis in stability testing should be on testing the final formulation in its proposed market packaging. As recommended by the FDA in the draft guidance on “Stability Testing of Drug Substances and Drug Products” (June 1998),² the manufacturing sites and facility for the production of these batches should ideally be the same as those for the marketed product. Details of site-specific stability are discussed in Section II.B.3.e.

4. Primary Stability Study

Because 12-month stability data are required at the time of regulatory submission for a new drug application, approximately 15 months before submission, stability batches are manufactured for the primary stability studies. The ICH guideline, the WHO guideline, and FDA guidance on stability are applicable. The objective of stability studies is to provide evidence on how the quality of the finished product varies with time under the influence of a variety of environmental factors such as temperature, humidity, and light and to enable recommended storage conditions and shelf life to be established. The requirements of the ICH stability guideline and the FDA guidance on stability

for the finished products are selection of batches, packaging/containers, test attributes, test procedures, acceptance criteria, testing frequency, storage conditions, storage period, data evaluation, and statements/labeling. More details on the guidelines and guidance content are given below.

5. Test Attributes, Procedures, and Acceptance Criteria

Testing should cover those attributes susceptible to change during storage and most likely to influence quality, safety, and/or efficacy of the product. All analytical methods must be validated according to the ICH guidelines Q2A, “Text on Validations of Analytical Procedures,” and Q2B, “Methodology” (see Appendix). For validation of a chromatographic procedure, the FDA has issued a guideline, that details the validation requirements, “Reviewer Guidance, Validation of Chromatographic Methods.”¹³ For stability studies, the analytical methods are capable of detecting and quantitating degradation products of the active and products from interaction, of the active with excipients and/or container components. The analytical methods should also be able to separate these products from synthetic process impurities of the active ingredient. For a solid dosage form, the dissolution methods should be validated to detect significant manufacturing variations in the process.

Specifications for the finished product that apply through the shelf life of the product should be proposed. The specification should include physical, chemical, chromatographic, and microbiologic characteristics of the product. The acceptable limit for degradation product after storage under the recommended conditions should be set before the stability investigation starts. This should include individual and total upper limits for degradation products. ICH guideline Q3B(R), “Impurities in New Drug Products” (see Appendix), addresses degradation products in new drug products. The degradation products of the active or interaction products from the active and excipient and/or active and container component should be reported, identified, and/or qualified when the suggested thresholds are exceeded.

In ICH Q3B(R) (see Appendix), the thresholds for the drug product for reporting, identification, and qualification of the degradation product are specified. The suggested thresholds are shown in Tables 9–11.

Higher thresholds may be proposed with justification and qualification if the target-reporting threshold cannot be achieved. For toxic impurities and degradation products, the proposed specification limit should be much lower than that recommended in the ICH guideline to ensure the safety of the product.

TABLE 9 Thresholds for Reporting Impurities

Maximum daily dose	
≤1 g	0.1%
>1 g	0.05%

TABLE 10 Thresholds for Identification of Impurities

Maximum daily dose	Threshold for identification
<1 mg	1.0% or 5 µg of total daily intake, whichever is lower
1–10 mg	0.5% or 20 µg of total daily intake, whichever is lower
>10 mg–2 g	0.2% or 2 mg of total daily intake, whichever is lower
>2 g	0.1%

6. Selection of Batches

As recommended in the ICH guideline, data from primary stability studies are to be collected for at least three batches of the drug product. Two of the three batches should be at least pilot scale that is representative of and simulates the full scale or 100,000 tablets or capsules. The third batch may be smaller, for example, 25,000 to 50,000 tablets or capsules for solid oral dosage forms. The manufacturing process used for primary batches should simulate the process for production batches and should provide product of the same quality that meets the specifications intended for marketing. Where possible, batches of the drug product should be manufactured using different batches of drug substance. Laboratory scale batches are not acceptable for primary stability studies. Data on associated formulations or packaging may be used as supporting data.

B. Packaging/Containers

Primary packaging materials play an important role for the stability of a formulated product since primary packaging materials are in direct contact with the drug at all times until consumer utilization. Stability testing should be conducted on the dosage form stored in the package proposed for marketing. Additional testing of unprotected drug product can form a useful part of stress testing and package evaluation, as can studies carried out on other related packaging materials in supporting the primary packages.

The primary packaging materials are tested and qualified for medical product use. A primary component means a package component that is or may be in direct contact with the dosage form. The FDA issued draft guidance on packaging components “Container Closure Systems for Packaging Human Drugs and Biologics.”¹⁴ The type and extent of information that should be provided in an application, such as an NDA, will depend on the dosage form and the route of administration. More detailed information usually should be provided for a

TABLE 11 Thresholds for Qualification of Impurities

Maximum daily dose	Threshold for qualification
<10 mg	1.0% or 50 µg total daily intake, whichever is lower
10–100 mg	0.5% or 200 µg total daily intake, whichever is lower
>100 mg–2 g	0.2% or 2 mg total daily intake, whichever is lower
>2 g	0.1%

liquid-based dosage form than for a powder or a solid, because a liquid-based dosage form is more likely to interact with the package components.

C. Testing Frequency

In ICH Q1A(R),¹ it is recommended that frequency of testing should be sufficient to establish the stability attributes of the new drug product. For products with a proposed shelf life of at least 12 months, the testing frequency at the intended storage condition will be every 3 months over the 1st year, every 6 months over the 2nd year, and then annually. For the accelerated storage conditions, a minimum of three test points, including the initial and end point, for example, 0, 3, and 6 months, is recommended. When testing at the intermediate storage condition is necessary as a result of failure at the accelerated storage condition, a minimum of four test points, including the initial and end points is recommended, for example, 0, 6, 9, and 12 months.

D. Storage Conditions and Period

Stability studies on the finished product should be sufficient to cover storage, shipping, and subsequent use, including reconstitution or dilution of the product if appropriate. The storage condition at which long-term testing is conducted will be reflected in the labeling and expiration date. It is recommended by the ICH guideline that long-term testing should cover a minimum of 12 months at the time of submission and should be continued for a sufficient period to cover the proposed shelf life. Additional data accumulated during the assessment period of the registration application should be submitted to the regulatory agencies if requested. Data from the accelerated storage condition or from the intermediate storage condition as appropriate may be used to evaluate the impact of short-term excursions outside the label storage conditions, such as those that might occur during shipping.

The storage conditions recommended by the ICH are given in Table 12. It would normally be expected that data would be generated at 25 °C/60% RH and at 40 °C/75% RH, but alternative justified conditions will be accepted. For example, for products with normal storage conditions that would be lower than 25 °C/60% RH, such as a 5 °C condition, the accelerated condition would be 25 °C/60% RH. The intermediate condition would be used when “significant change” for the product occurs. In general, significant change is defined as

1. A 5% loss of potency from the initial value

TABLE 12 ICH Drug Product Storage Conditions

Test	Conditions	Minimum period
Long term	25 ± 2 °C/60 ± 5% RH	12 mo
Intermediate	30 ± 2 °C/60 ± 5% RH	6 mo of data from 12-mo study
Accelerated	40 ± 2 °C/75 ± 5% RH	6 mo

2. The level of specified degradation product exceeding its specification limit
3. The product exceeding its pH limit
4. Dissolution performance falling outside the specification
5. Failure to meet acceptance criteria for appearance and physical properties, such as color, phase separation, resuspendability, delivery per actuation, caking, and hardness

Other storage conditions may be used if justified. Special consideration should be given to products that change physically or chemically at storage conditions lower than normal, such as suspensions and emulsions, creams or oils. In the FDA draft revised guidance entitled “Q1A(R): Stability Testing of New Drug Substances and Products,”¹² effects of high- and low-humidity environments on impermeable or semipermeable containers are discussed. In these cases, moisture gain and loss should be monitored during stability studies.

I. Design of Matrixing and Bracketing Studies

Matrixing or bracketing studies may be applied if justified. Matrixing or bracketing would normally be acceptable in the following cases:

1. Strength changes with no or a small change in the proportion of ingredients
2. Container size changes with the same contact materials
3. Change to an equivalent closure system
4. Change of manufacturing site within the same company
5. Change in batch size

Matrixing would normally be acceptable in the following cases:

1. Strength changes associated with significant changes in the proportions of ingredients
2. Changes to fill volumes in containers
3. Changes to a nonequivalent closure system
4. Changes to the manufacturing process
5. Introduction of manufacturing by a different company

In the experimental design for bracketing or matrixing, initial and final time points should be included for all environments. The statistical basis of a low testing matrix such as a 1/3 design or other statistics-based design should be used. Consultation with regulatory agencies may be advisable before a complex matrix design is used. In the FDA draft guidance on “Stability Testing of Drug Substances and Drug Products,”² examples of bracketing and matrixing are provided. An example of a bracketing design is presented in Table 13. In this situation, the capsule dosage form is available in three strengths made from a common granulation and packaged in three different sized high-density polyethylene bottles with different fill sizes: 30 counts, C1; 100 counts, C2; and 200 counts, C3. The surface area/volume ratio, dead space/volume ratio, container wall thickness, and closure performance characteristics are assumed to be proportional among the three containers/fill sizes for each strength of

TABLE 13 Bracketing Example

Batch	1			2			3		
	100 mg	200 mg	300 mg	100 mg	200 mg	300 mg	100 mg	200 mg	300 mg
Container/ Closure	C1 C2 C3	C1 C2 C3	C1 C2 C3	C1 C2 C3	C1 C2 C3	C1 C2 C3	C1 C2 C3	C1 C2 C3	C1 C2 C3
Sample for stability	× ×		× × ×	× × ×		× × ×	× × ×		× × ×

capsules. Both strengths and container/fill sizes are bracketed in one protocol and the “×” denotes the combination of strengths and container/fill size to be used for the stability study. Additional examples are available in the guidance.

The stability of the active ingredient and the physical stability of the dosage form may affect the design of reduction in the testing. With a very stable drug and a conventional tablet formulation, a 1/3 matrix could be acceptable. However, if evidence of significant change is found during the real-time testing of the stability studies, the testing frequency will need to be increased for the remaining part of the investigation.

After the approval of the new product by the regulatory agencies, the first three production batches of drug product manufactured postapproval should be selected for long-term stability studies. The acceptance criteria should be the same as those in the approved drug application. After the first three production batches, long-term stability studies should be conducted on at least one batch of the product annually.

2. Bulk Holding Studies for Drug Product Intermediates

In the FDA draft guidance on “Stability Testing of Drug Substances and Drug Products,”² the holding times for drug product intermediates is discussed. Drug product intermediates such as blends, triturates, cores, extended release beads, or pellets may be held for 30 days from the date of manufacturing without re-test before use. An intermediate that is held for longer than 30 days should be monitored for stability under controlled, long-term storage conditions for the length of the holding period. In addition, the finished product manufactured with such an intermediate should be monitored for long-term stability for the remainder of the shelf life. The frequency of stability testing for an intermediate is related to the length of the holding time. Where practical, testing should be done at a minimum of three time points after the initial testing. All critical parameters should be evaluated at release of an intermediate and immediately before its use in the manufacture of the finished drug product.

E. Data Evaluation

In ICH Q1A(R),¹ data evaluation is addressed. For data that show little degradation and little variability, it is apparent from looking at them that the requested re-test period should be granted. Under these circumstances, it is

normally not necessary to go through the formal statistical analysis but a full justification for the omission must be provided.

An acceptable approach for quantitative characteristics that are expected to change with time is to determine the time at which the 95% one-sided confidence limit for the mean curve intersects the acceptable specification limit. If it is shown that the batch-to-batch variability is small, it is advantageous to combine the data into one overall estimate; this can be done by first applying appropriate statistical tests to the slopes of the regression lines and zero time intercepts for the individual batches. If it is inappropriate statistically to combine data from several batches; the overall re-test period may depend on the minimum time a batch may be expected to remain within acceptable limits.

The nature of any degradation mechanism will determine the need for transformation of the data for linear regression analysis. Usually, the relationship can be represented by a linear, quadratic, or cubic function on an arithmetic or logarithmic scale. Statistical methods should be used to test the goodness of fit of the data on all batches to the assumed degradation line or curve.

Limited extrapolation of the real-time data from the long-term testing storage condition beyond the observed range to extend the re-test period at approval time may be undertaken, particularly if the accelerated data are supportive. However, this assumes that the same degradation relationship will continue to apply beyond the observed data. Hence the use of extrapolation should be minimized but can be justified in an application in terms of what is known about the mechanism of degradation, the goodness of fit of any mathematical model, batch size, and existence of supportive data.

Any evaluation should cover not only the assay, but also the levels of degradation products and other attributes.

F. Statements and Labeling

In ICH Q1A(R),¹ the recommendation for statements for labeling is given. A storage temperature range may be used in accordance with relevant national/regional requirements. The range should be based on the stability evaluation of the drug product. Where applicable, specific instruction should be provided, particularly for drug products that cannot tolerate freezing. There should be a direct linkage between the label statement and the demonstrated stability characteristics of the product. The use of terms such as “ambient conditions” or “room temperature” is not acceptable.

G. Postmarketing Changes

Even after an application has been approved and the product has been marketed, consideration should be given to the effects of changes in the manufacturing formula or manufacturing process. Bioequivalence of the product and the stability properties may be affected. Appropriate studies will therefore need to be conducted, and applications for the changes will need to be submitted as necessary.

VI. SUMMARY

Operating a dynamic, compliant stability program requires more than just knowing and adhering to the various regulatory requirements. It also requires management of the stability samples, the environmental chambers, and all of the associated documentation. Standard operating procedures, processes for protocol amendments and deviations, and out-of-specification investigations are all key elements of a compliant stability program. This chapter describes how to manage both the operational elements and the regulatory compliance issues to ensure a successful application and inspection by any regulatory agency. The FDA, WHO, and ICH guidelines related to stability have been discussed in detail.

GLOSSARY

- bracketing** The design of a stability schedule so that at any time point only the samples at the extremes are tested. The assumption is that the stability of any intermediate is similar to that obtained at the extremes. This type of study is most commonly applied to containers and dosage strengths. For containers it is assumed that the composition and closure systems are the same for all size variations. For dosage strengths it is assumed that there is very little change in the ratio of drug substance to excipients across the dosage range.
- developmental stability** Stability studies conducted in the early stages of product development when various formulations are being assessed with the intent of trying to select the formulation that will have the longest shelf life. Other factors, such as tablet compressibility, may influence these studies. These studies may or may not be protocol driven, depending upon the stage of development.
- good manufacturing practices (GMPs)** Practices or procedures that the regulatory agencies currently consider to be the standard, accepted manner of operation.
- International Conference on Harmonisation (ICH)** The ICH was formed to provide an opportunity for tripartite harmonization initiatives to be developed with input from both regulatory and industry representatives. The ICH is sponsored by the European Commission, the European Federation of Pharmaceutical Industry Associations, the Japanese Ministry of Health and Welfare, the Japanese Pharmaceutical Manufacturers Association, the U.S. Food and Drug Administration, and the Pharmaceutical Research and Manufacturers of America. The objective of the ICH is to harmonize the technical requirements for the registration of pharmaceutical products in the European Union, Japan, and the United States.
- laboratory information management system (LIMS)** LIMS is a computerized database that allows the tracking of samples, their various attributes, and data collected on them. Using appropriate software, the data can be used in many ways during the development process, for example, to justify the shelf life recommendations.

- matrixing** Matrixing is the statistical design of a stability schedule so that only a fraction of the total number of samples is tested at any specified time interval. At a subsequent time interval, different sets of samples of the total number would be tested. The design assumes that the stability of the samples tested represents the stability of all samples. Matrixing can allow reduced testing when more than one variable is being evaluated. Thus, the design of the matrix will be dictated by the factors being evaluated. In every case, however, the initial and end point samples of all batches must be tested. Whenever matrixing is to be used for a complex study, prior agreement with the appropriate regulatory agency is strongly recommended.
- mean kinetic temperature** A single derived temperature that if maintained over a defined period, would afford the same thermal challenge to a drug substance or drug product as would have been experienced over a range of both higher and lower temperatures for an equivalent defined period. The mean kinetic temperature is higher than the arithmetic mean temperature and takes the Arrhenius equation into account. The formula by J. D. Haynes (*J. Pharm. Sci.* 60:927, 1971) can be used to calculate the temperature.
- new drug application (NDA)** An NDA is a formal submission to the U.S. Food and Drug Administration requesting permission to market a new product within the United States and its territories.
- out-of-specification (OOS) value** An OOS value is a measured result obtained from a sample that does not comply with a predetermined specification. When an OOS value is confirmed, an investigation of the specific batch and related batches is required to determine the cause and impact of the failure.
- preapproval inspection (PAI)** A PAI is an inspection by the FDA of the facilities that are proposed as the manufacturing, packaging, and testing sites in the NDA. The PAI normally occurs during the review process, but can occur postapproval. Besides inspecting the facilities, the documentation will be reviewed for compliance to GMPs and SOPs and to verify the integrity of the data in the submission.
- probe stability** See developmental stability.
- re-test date** The date after which a drug substance sample should be evaluated to ensure that it still complies with all specifications.
- site-specific stability (SSS)** Stability studies conducted on primary stability batches manufactured at the proposed commercial scale and site.
- standard operating procedures (SOPs)** The documented procedures and practices that are the standard way of conducting business within an organization. The regulatory agencies expect that there are SOPs for critical functions and manner of behavior by employees. The organization must be able to document the training of its employees on all SOPs that apply to them. Any deviation from SOPs must be documented and be available for inspection during a PAI. The SOP system should be a viable, flexible system that is constantly under review and modified to reflect the actual practices of the organization at that time.

APPENDIX

The following information is available at <http://www.ifpma.org/ich5q.html>:

Q1B: Photostability Testing. *Step 5*: The tripartite harmonised ICH guideline was finalised (*Step 4*) in November 1996. This document is an annex to the main stability guideline, and gives guidance on the basic testing protocol required to evaluate the light sensitivity and stability of new drugs and products.

Q1C: Stability Testing for New Dosage Forms. *Step 5*: The tripartite harmonised ICH guideline was finalised (*Step 4*) in November 1996. It extends the main stability guideline and defines the circumstances under which reduced stability data can be accepted, at the time of filing an application, in the case of new formulations of already approved medicines.

Q2A: Text on Validations of Analytical Procedures. *Step 5*: The tripartite harmonised ICH text was finalised (*Step 4*) in October 1994. This identifies the validation parameters needed for a variety of analytical methods. It also discusses the characteristics that must be considered during the validation of the analytical procedures which are included as part of registration applications.

Q2B: Methodology. *Step 5*: The tripartite harmonised ICH text was finalised (*Step 4*) in November 1996. It extends the previous text to include the actual experimental data required, along with the statistical interpretation, for the validation of analytical procedures.

Q3A(R): Impurities in New Drug Substances (Revised Guideline). *Step 3*: This Guideline is now under revision and therefore a draft was released for consultation at *Step 2* of the process in October 1999. This provides guidance on limits and qualification of impurities in new drug substances, produced by chemical synthesis. The guideline is being widely followed by companies involved in new drug development, to ensure that a single drug substance specification is developed which is acceptable in all three regions.

Q3B(R): Impurities in New Drug Products (Revised Guideline). *Step 3*: This Guideline is now under revision and therefore a draft was released for consultation at *Step 2* of the process in October 1999. This is an extension of the main guideline on impurities in new drug substances and makes recommendations on the content and qualification of impurities that may arise in the drug products due to degradation of the active ingredient or interaction with other components.

Q5C: Stability of Products. *Step 5*: The tripartite harmonised ICH guideline was finalised (*Step 4*) in November 1995. This forms an annex to the main ICH Stability Guideline (Q1A above) and deals with the particular aspects of stability test procedures needed to take account of the special characteristics of products, in which the active components are typically proteins and/or polypeptides.

Q6A: Chemical Substances. *Step 5*: Specifications: Test Procedures and Acceptance Criteria for New Drug Substances and New Drug Products. The tripartite harmonised ICH guideline was finalised (*Step 4*) in October 1999. This addresses the process of selecting tests and methods and setting specifications for the testing of drug substances and dosage forms. Account has been

taken of the considerable guidance and background information, which are present in existing regional documents.

The following information is available at <http://www.fda.gov/cder/guidance/>:

[//www.fda.gov/cder/guidance/](http://www.fda.gov/cder/guidance/):

SUPAC-IR: Immediate-Release Solid Oral Dosage Forms: Scale-Up and Post-Approval Changes: Chemistry, Manufacturing and Controls, In Vitro Dissolution Testing, and In Vivo Bioequivalence Documentation (issued November 1995).

SUPAC-IR: Questions and Answers about SUPAC-IR Guidance (issued February 1997).

SUPAC-IR/MR: Immediate Release and Modified Release Solid Oral Dosage Forms Manufacturing Equipment Addendum (issued January 1999).

SUPAC-MR: Modified Release Solid Oral Dosage Forms Scale-Up and Postapproval Changes: Chemistry, Manufacturing, and Controls; In Vitro Dissolution Testing and In Vivo Bioequivalence Documentation (issued October 1997).

SUPAC-SS: Nonsterile Semisolid Dosage Forms; Scale-Up and Post-Approval Changes: Chemistry, Manufacturing, and Controls; In Vitro Release Testing and In Vivo Bioequivalence Documentation (issued May 1997).

WHO documents can be found at <http://www.who.int/>.

REFERENCES

1. Q1A(R): Stability Testing of New Drugs and Products (Revised Guideline), International Conference on Harmonisation, issued October 1999.
2. Stability Testing of Drug Substances and Drug Products (Draft Guidelines), Food and Drug Administration, issued June 1998.
3. *USP 24-NF 19*, United States Pharmacopeial Convention, Inc., Rockville, MD, 2000.
4. *Quality Assurance of Pharmaceuticals: A Compendium of Guidelines and Related Materials*, Vol. 2: *Good Manufacturing Practices and Inspection*. World Health Organization, Geneva, 1999.
5. *Quality Assurance of Pharmaceuticals: A Compendium of Guidelines and Related Materials*, Vol. 1. World Health Organization, Geneva, 1997.
6. Grimm, W. *Drug Dev. Ind. Pharm.* 19:2795–2830, 1993.
7. Cloud, P. A. *BioPharm* Nov:30–42, 1997.
8. *United States v. Barr Laboratories, Inc.* Civil Action No. 92–1744, U.S. District Court for the District of New Jersey; 812 F. Supp. 458; 1993 U.S. Dist. Lexis 1932; 4 February 1993, as amended 30 March 1993.
9. Excipient Biological Safety Evaluation Guidelines, General Chapter <1074>, and Excipients: USP and NF Excipients, Listed by Categories, pp. 2404–2406, in *USP 24-NF 19*. U.S. Pharmacopeial Convention, Rockville, MD, 2000.
10. *The Merck Index*, Eleventh Edition, item 4856. Merck & Company, Rahway, NJ, 1989.
11. Carstensen, J. T. *Pharmaceutics of solids and solid dosage forms*. Chap. VII-2, 1977.
12. Q1A(R): Stability Testing of New Drug Substances and Products (Draft, Revised Guidance), Food and Drug Administration, issued April 2000.
13. Reviewer Guidance, Validation of Chromatographic Methods, Food and Drug Administration, issued November 1994.
14. Container Closure Systems for Packaging Human Drugs and Biologics, Food and Drug Administration, issued May 1999.

This Page Intentionally Left Blank

14

ANALYTICAL METHODOLOGY TRANSFER

STEPHEN SCYPINSKI

Analytical Chemistry Research & Development, The R. W. Johnson Pharmaceutical Research Institute, Raritan, New Jersey 08869

- I. INTRODUCTION
- II. THE DRUG DEVELOPMENT PROCESS
- III. TYPES OF METHOD TRANSFER
 - A. Comparative Testing
 - B. Covalidation between Two Laboratories
 - C. Method Validation and/or Revalidation
 - D. Transfer Waiver
- IV. REQUIREMENTS AND ELEMENTS OF ANALYTICAL TECHNOLOGY TRANSFER
 - A. Preapproved Test Plan/Standard Operating Procedure/Protocol
 - B. Description of Methods/Test Procedures
 - C. Description of Test Requirements
 - D. Rationale for Test Requirements
 - E. Acceptance Criteria
 - F. Documentation of Results
- V. TECHNICAL TRANSFER TIME LINE/PROJECT PLAN
- VI. ANALYSIS OF RESULTS/STATISTICAL PACKAGES
- VII. ANALYST CERTIFICATION AND TRAINING
- VIII. TRANSFER OF TECHNICAL OWNERSHIP
 - A. Method Development Report
 - B. Analytical Development Report
 - C. Transfer File
- IX. CHAPTER SUMMARY
- REFERENCES

I. INTRODUCTION

The process for the transfer of analytical methodology is, on the surface, a relatively simple operation. In its most common form, analytical method transfer is the verification that a method or test procedure works in an equivalent fashion at two or more different sites or laboratories and meets all acceptance criteria. This process is driven by compliance and governed by a statistical treatment of the resulting data. This “interlaboratory transfer” aspect of the overall transfer process has been covered comprehensively by McGonigle, who stressed that successful transfers are linked to the method validation process. Method transfer was defined in this case as “the introduction of a validated method into a designated laboratory so that it can be used in the same capacity for which it was originally developed.”¹ The second portion of the technology transfer

process concerns the transfer of technical “ownership” from one laboratory to another. This latter type of transfer is usually associated with the movement of drug development projects from research and development to operations. In many case studies involving technical transfer, the process of ensuring that the receiving laboratory is sufficiently familiar with all scientific aspects of the project is not carried through to fruition. Indeed, rapid and complete transfers are crucial to the success of process validation experiments for pharmaceutical dosage forms. The importance of analytical transfer was recently underscored by the Analytical Research and Development Steering Committee (ARDSC) of the Pharmaceutical Research and Manufacturers Association (PhRMA) at their annual workshop.² At this meeting, representatives from PhRMA member companies met with facilitators to draft an “Acceptable Analytical Practice” (AAP) that will function as a suitable template for successful method transfer. The AAP on analytical technical transfer will be published for general comment by the industry in the coming months.³ Both facets of technology transfer will be dealt with in this chapter. The early portions will discuss the transfer of analytical methods while the later sections will highlight the documentation requirements.

II. THE DRUG DEVELOPMENT PROCESS

All large pharmaceutical companies develop products by using similar general processes, as depicted in Figure 1 and described in detail elsewhere in this text. Although there are a plethora of internal initiatives targeted at reducing the time line of drug development and hence the overall time to market, the basic process of drug development has remained unchanged. Pharmaceutical analysts working in research and development (R&D) develop and refine

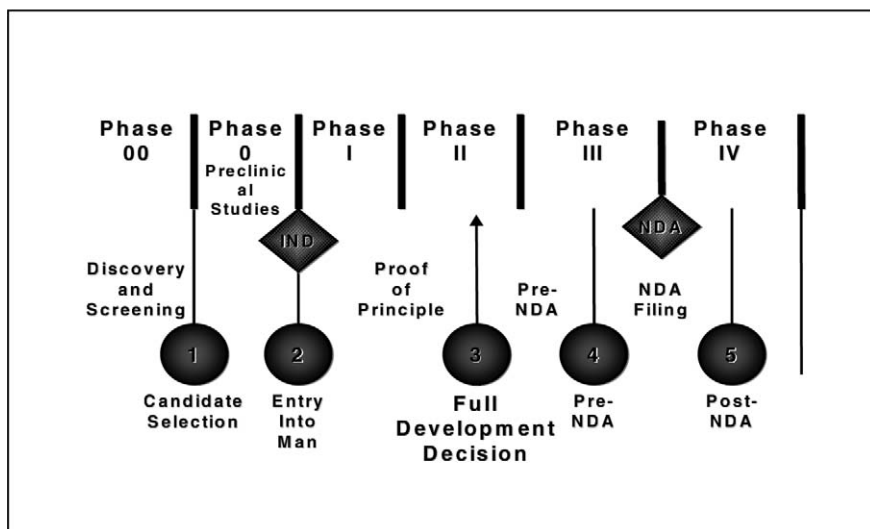

FIGURE I The phases of drug development from a clinical perspective.

the methods that will eventually be used to test the identity, quality, purity, potency, and composition of marketed products. It is not unusual for analytical methods to undergo multiple iterations during the development life cycle of a pharmaceutical product. Method alterations are a result of changes to any number of product parameters, including, but not limited to, active pharmaceutical ingredient (API) synthesis, formulation composition, and dosage form manufacturing processes. Although it is important to keep the needs of the quality unit in mind when refining the methods for which they will eventually have technical ownership, a great many quality units do not become intimately involved with such changes. At the conclusion of development, when methods are to become “locked,” it is becoming more common for the analysts to ask the quality unit for input and comment on the proposed method package before final validation. Such a method “test drive” can avoid problems with the formal transfer taking place later. This process has been termed analytical method evaluation ring test (AMERT) by Crowther and associates and was presented and described elsewhere.^{4,5} In brief, this process allows the quality unit to make comments and suggestions to their R&D colleagues before the final validation of the method. Thus, the frequently seen “throw the method over the fence” syndrome is avoided.

By assuming that the clinical development plan proceeds smoothly, the formal transfer of analytical methods takes place during the latter part of clinical phase III. At this point, the requirements for analytical technical transfer are outlined by R&D and operations and are suitably executed. The details for the transfer process are discussed later in this chapter. After successfully meeting appropriate acceptance criteria, the receiving laboratory is now considered to be “qualified” and able to generate “reportable” data as defined by current good manufacturing practices. In most companies, further transfers taking place after the approval of a product are driven and administered by the quality unit. Included may be transfers to a contract research organization (CRO) or to multiple manufacturing and testing sites. Due to time constraints, an R&D organization may sometimes transfer methods to multiple sites simultaneously. Such transfers become complicated statistically and will also be discussed later in this chapter.

III. TYPES OF METHOD TRANSFER

Method transfer is loosely defined as a process that qualifies a laboratory to use a test procedure or analytical method. According to this definition, any and all means of having a laboratory qualified would meet the criteria for transfer. The most common variations of method transfer are comparative testing, covalidation between two laboratories or sites, complete or partial method validation or revalidation, and the omission of formal transfer processes, sometimes termed the transfer “waiver.”

A. Comparative Testing

Comparative testing is the most common form of transfer in the pharmaceutical industry. It involves two or more laboratories or sites executing a preapproved protocol that details the criteria by which the receiving laboratory is deemed to be “qualified” to use the method(s) being transferred. The resulting data are analyzed statistically and compared to the acceptance criteria. Comparative testing is also used in other scenarios during development and after approval. These include alliance partners, CROs, and other internal development groups, for example, the movement of a project between functional areas or development sites.

B. Covalidation between Two Laboratories

An alternative to comparative testing is to involve the receiving laboratory in the validation of the method(s). By definition, a laboratory or site that performs validation experiments is qualified to use that method for its intended purpose. To perform such a transfer, it is necessary to identify which validation parameters are to be generated or challenged by each partner. A reasonable approach is to involve the receiving laboratory in the interlaboratory qualification, thereby generating a matrix of data that summarizes the effect of testing site, analyst, date of analysis, and instrumentation. By including these data in the method validation report and fully describing the experimental design for the validation exercise, it is possible to have this document stand as proof of the analytical transfer.

C. Method Validation and/or Revalidation

Before the performance of method transfer activities involving protocols and acceptance criteria, it was customary for a receiving laboratory to repeat some or all of the validation experiments. This laboratory was thereby deemed to be qualified as described above. The choice of validation parameter(s) depends highly on the type of method being transferred. For example, content uniformity assays to determine consistency of product potency depend heavily on the method and system precision. As a second example, a determination of trace impurities in an API could not be reproduced between two sites if their instruments did not yield similar limits of detection and limits of quantitation. A detailed discussion on the rational choice of validation parameters that would need to be repeated by the receiving laboratory is beyond the scope of this chapter. The reader is referred to the method validation chapter by Crowther *et al.*⁵ for additional information on this subject.

D. Transfer Waiver

Certain situations might certainly warrant the omission of conventional transfer qualification experiments. To proceed without some manner of laboratory comparison between the two sites, it is critical to document the reasons for making such a decision. For line extensions involving dosage forms that are

routinely tested by the receiving laboratory, it may be possible to waive the transfer for the following reasons:

- The receiving laboratory is already testing the product and is thoroughly familiar with the procedure(s).
- The new dosage form possesses either a comparable composition and/or concentration of API relative to the existing product.
- The analytical method(s) are the same as or very similar to those that are already in use.
- The method validation package encompasses the new methods.

IV. REQUIREMENTS AND ELEMENTS OF ANALYTICAL TECHNOLOGY TRANSFER

In this section, the various components necessary to complete a successful comparative testing transfer will be presented and discussed. As will be noted, many of the factors necessary for a compliant transfer are interrelated.

A. Preapproved Test Plan/Standard Operating Procedure/Protocol

Before the planning of any transfer, an approved document that describes both the general transfer process as well as the specific acceptance criteria necessary for the method(s) being transferred needs to be in place. In many companies, it is common for both the R&D and quality units to have general standard operating procedures (SOPs) that govern the transfer process. These SOPs describe the details of a method transfer protocol that is specific to the product and methods. The contents of such a protocol were described in various chapters earlier in this text; however, they are important and bear repeating here.

- Clearly define responsibilities of both the transferring and receiving laboratories.
- A list of all methods to be transferred via comparative testing. Rationale for any methods not included, i.e., transfer waiver, must also be provided.
- The scope of the transfer should be provided with respect to what laboratories and analysts are affected by the transfer. In some cases, direct analyst-to-analyst transfer might be necessary due to method complexity or the use of new or unfamiliar equipment. In the case of automated methods, transfer from specific robots or workstations in R&D to comparable systems within operations would need to be performed.⁶ The subject of analyst training and certification will be discussed later in this chapter.
- The selection materials and samples to be used in the transfer should be described in detail. In general, one does not choose “GMP released” materials for transfer activities because the result of not meeting the predetermined acceptance criteria could be an out-of-specification (OOS) investigation. The identity and lot numbers of specific batches should be given. If possible, certificates of analysis for all samples, including reference standards, should be supplied. The instrumentation should be

described, including any disclaiming statements that may affect the outcome of the transfer. The author is aware of cases where very robust methods have failed due to improper assumptions regarding instrumentation. In the case of gradient high-performance liquid chromatography (HPLC) methods, the gradient that is formed in the pump via low- or high-pressure mixing can drastically affect the column performance, thereby leading to changes in retention time, capacity factor, and resolution. These and other factors that may affect the success of the transfer of HPLC methods have been thoroughly discussed in a classic paper by Kirschbaum.⁷ The reader is also referred to classical discussions on the effect of instrumentation on the performance of chromatographic methods for elaboration on this subject.⁸ It is recommended that the instrumentation be held constant during the transfer. Alternatively, it is recommended that the developing laboratory consider running the method on instrumentation commonly used in the quality unit before formal transfer.

B. Description of Methods/Test Procedures

It is imperative that copies of all methods used during the transfer are included. Any validation data that are available should be given to the receiving laboratory. One should include any idiosyncrasies present in the method. A difficult method is not necessarily “nonrugged.” Rather, the developer must stipulate very carefully the steps that need to be followed and any pitfalls that might occur. This can even be the case with compendial methods, which do not necessarily need to be formally transferred. Due to the general nature of descriptions of compendial methods, receiving laboratories often run into difficulty executing them. For example, the United States Pharmacopeia (USP) monograph for ethinyl estradiol states in the sample preparation for the drug substance assay, “Transfer about 25 mg of ethinyl estradiol, accurately weighed, to a 25 mL volumetric flask, add mobile phase to volume, and mix.”⁹ The general monograph does not state that one needs to exercise care when preparing standards of this nature due to the effect of humidity or temperature, which could skew the assay results. In all method procedures, step-by-step directions should be given, including “tips and tricks,” safety considerations, and clear formulas and calculations.

C. Description of Test Requirements

As part of the specific transfer, the number of lots, replicates, and injections (in the case of HPLC) should be expressly presented. For dissolution transfers, the number of individual dosage forms that will be tested should be stipulated. It is necessary to spell out such details so that small differences in the everyday analytical philosophies do not perturb the transfer process. In the case of new techniques that may not be common to the receiving laboratory (i.e., capillary electrophoresis or liquid chromatography/mass spectroscopy), specific training may be necessary before the execution of a transfer protocol.

D. Rationale for Test Requirements

As in any scientific document, one must provide a rationale for the parameters chosen and their effect on the overall success of the transfer. This includes an explanation for the system suitability parameters that have been established for the method. System suitability can be a powerful tool for troubleshooting method discrepancies in addition to being a test of the conformance of the system to a set of parameters before analysis.¹⁰

E. Acceptance Criteria

The transfer protocol must include suitable acceptance criteria relevant to the tests and specific dosage forms. It should be noted that giving hard and fast specifications for such criteria is not possible. There would surely be more exceptions than norms. At the recent PhRMA ARDSC workshop on method transfer, individuals gave answers that spanned a variety of approaches. Table 1 summarizes some of the responses to questions about acceptance criteria for analytical methods.

This table clearly shows that the discrete acceptance criteria vary considerably from company to company. It does illustrate, however, that having systems in place to challenge the performance of a method during transfer is absolutely required.

F. Documentation of Results

The results of the comparative testing experiments should be documented in a report summarizing all experiments and results. Considerable attention must be paid to details of all aspects, observations, and results of the experiments. In some cases, the results for the receiving laboratory may not meet the established acceptance criteria. Such situations should be addressed by a policy that must be in place to describe how such data would be handled. PhRMA workshop attendees were almost unanimous in stating that such “failed” acceptance criteria did not constitute the need for an OOS investigation. Regardless of whether such a policy is followed, an investigation into all results that fall outside of the acceptance criteria should be performed and summarized.

TABLE I Select Acceptance Criteria for Assay Methods from PhRMA ARDSC Attendees, September, 2000^a

Question	Response
Do you perform linearity upon transfer?	Yes and no
How many lots for transfer?	2, 3, covalidation and 1 other lot; bracket high and low strengths if applicable
How many repetitive analyses?	1 through 6 depending on % relative standard deviation
How many analysts at receiving site?	1, 2 (some with same analyst but different equipment, day, etc.)
Do you spike samples for impurities?	Yes and no (even split)

^aInformation from reference 2.

V. TECHNICAL TRANSFER TIME LINE/PROJECT PLAN

As has been stated previously, the time line for formal transfer most often has the process taking place in the middle to late clinical phase III. This assumes that the quality unit has given input via sample communication or the AMERT has taken place. The timing for the technical transfer must be flexible, depending on the specific product. It must take into account the need to have methods in place within operations before regulatory approval or product launch. For example, Kassal *et al.*¹¹ documented transfer of an in-process control method for bulk steroid APIs. In this work, the authors successfully transferred an overpressured layer chromatographic method from a quality control unit to an in-process laboratory. They used comparative testing as the basis for the transfer. One must know that the receiving laboratory has met all criteria to be qualified to perform the methods and associated testing before the arrival of actual samples. For example, if process characterization or production of registration batches for pivotal stability studies will be done by operations, transfer must take place earlier than phase III. Figure 2 gives a rough time line for method transfer including the major milestones within the development life cycle. In like fashion, movement of methods from “first in human” or “proof of principle” groups to full development organizations must also take place early in the genesis of a product. Such transfers can be considered complex because early projects have less well-defined analytical methods and will therefore be more difficult to transfer according to defined acceptance criteria. Many large pharmaceutical companies are today using a team structure to develop products for market. Within such teams, it is typical to include individuals who represent the quality unit at the appropriate time in the project history. These individuals are charged with defining the acceptance process for the analytical methodology and the overall technical transfer process for analytical methods, including the associated documentation.

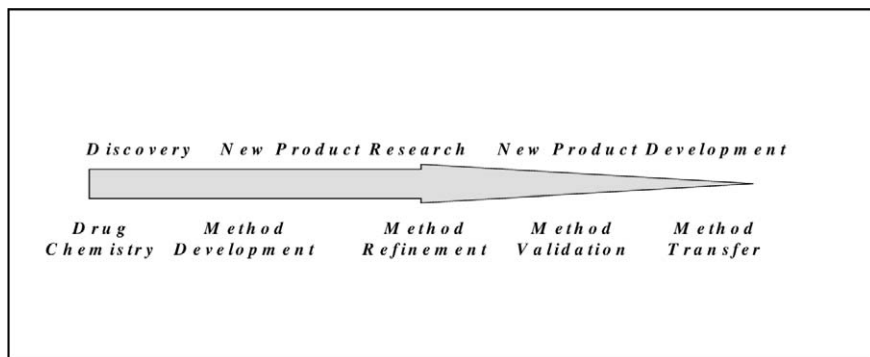

FIGURE 2 Generic technical method transfer time line.

VI. ANALYSIS OF RESULTS/STATISTICAL PACKAGES

The comparative testing type of technical transfer generates results that need to be compared using one or more statistical tools. Although one can certainly evaluate the data subjectively, the use of statistics will build objectivity into the data analysis and allow unbiased comparison of the data set(s). Because comparative testing involves destructive testing of individual samples, the strength of the transfer involves proving mathematically that the data sets are equivalent. The complexity of the data treatment is directly related to that of the method transfer. Many transfers are governed by the statistics of the standard Student's *t* test.¹²

The *t* test is useful for determining equivalence of like data sets and is generally sufficient for analyzing data results for comparative testing. A comprehensive review of statistical tools for data analysis is beyond the scope of this review. The reader is referred to several excellent reviews of statistics germane to analytical chemistry and comparative testing for method transfer.^{12, 13} There are also variations used for more elaborate transfer procedures. For example, the Anderson–Hauck test, originally developed for the determination of bioequivalence in clinical trials, has been used for more complex data sets.¹⁴ Table 2 lists the analytical results for a composite assay and impurity assay for a hypothetical product for a simultaneous transfer to three sites. These data were analyzed by the Anderson–Hauck test. As can be seen, the transfer of a method to more than a single site can involve extensive statistical analysis. Vial and several French co-workers¹⁵ documented the considerable statistical rigor for transfer of liquid chromatographic methods. Their work was especially relevant as they discussed certified materials, reanalysis, and other important factors.

TABLE 2 Percent Label Claim Data for a Drug Product Potency Assay Transferred to Four Sites Simultaneously

Method/Criteria	Site A	Site B	Site C	Site D	Requirement
Composite assay method					
Linearity	49.4	49.5	49.7	49.6	48.0–52.0%
Standard precision	0.8	1.1	1.4	1.1	≤2.0%
% deviation of 2 standards	1.3	0.7	2.0	1.4	≤2.0%
Impurity assay method					
System suitability (impurity 1)	6.4	2.2	5.9	8.8	≤10%
System suitability (impurity 2)	9.4	9.8	6.2	9.8	≤10%
Linearity	49.7	49.7	51.5	48.7	48.0–52.0%
Impurity 1	ND	< 0.1%	< 0.1%	< 0.1%	≤1.0%
Impurity 2	ND	< 0.1%	< 0.1%	< 0.1%	≤1.0%

VII. ANALYST CERTIFICATION AND TRAINING

During the performance of method transfer activities, the training component must not be taken lightly. More and more often companies are using operation sites outside the United States, sometimes in remote countries. If the personnel in the receiving laboratory do not speak the native language of personnel in the developing laboratory, translation of the method procedures may be necessary. It is also important to ensure that proper training of the analysts who will perform the method procedures has taken place. In some respects, the actual process of comparative testing might be considered to be biased because both the transferring and receiving laboratories will be paying close attention to the testing procedures. A better measure of the ruggedness of the method(s) would be a test of the methods once they were in routine use within the quality unit; however, this is impractical for documentation of the success of the transfer.

The actual training of the analysts at the receiving end of the methods is an area that has received considerable attention from regulatory authorities and internal quality assurance auditors. There are several options to certify analysts to perform the required test procedures. One possibility is to qualify individual analysts on each method, thereby creating a matrix of methods and analysts. Such an approach can become cumbersome as it would involve substantial documentation with respect to training records for individual analysts. Compliance liability could also result if an analyst who was not “certified” produced reportable GMP data.

An alternative to an individual method certificate is to qualify analytical chemists by technique, not method. This is the approach most often used by larger companies. Training records must include documentation that the individual is indeed competent to perform routine tests using specific transfers. In these cases, the supervisor or another qualified analyst can certify that the individual analyst is competent to perform the test procedure in question. Johnson and Johnson has taken this approach one step further and has instituted the Laboratory Analyst and Training Certification Program (LATCP), in which all analysts developing or executing methods for the release and/or stability of products for human consumption, either in a clinical study or after approval, attend a comprehensive 2-week course. The LATCP involves both theoretical classroom instruction and laboratory experimentation. At the conclusion of this course, students must pass an examination to become certified. This course and its associated subject material were recently described by Miller.¹⁶ In addition, the entire course content has been published as a textbook by Miller and Crowther.¹⁷ With the increasing emphasis of the authorities on training and analyst competency, there is no doubt that such programs will proliferate in the future.

VIII. TRANSFER OF TECHNICAL OWNERSHIP

At the heart of the technical transfer process is documentation. The old adage “if it isn’t written, it isn’t done” certainly applies to analytical transfer. The

R&D component of the drug development process depicted in Figure 1 encompasses several years, during which time the knowledge base surrounding a compound increases steadily. At the junction between R&D and operations, it is important to ensure not only that the analytical methods are successfully used by the quality unit, but also that the applicable knowledge and data are transferred or are readily accessible by the receiving laboratory. Although the quality unit might not require excessive detail regarding all scientific research performed during the R&D period, some information transfer is necessary. Rather than inundate the quality unit with a large number of lengthy reports, several concise documents that meet the specific needs of an operations-based analytical unit are preferred. In most companies, the most important reports are the method development/validation reports and analytical development reports.

A. Method Development Report

The method development report may be a part of the method validation report. This report should provide a concise summary of the development of the key analytical methods used to assure the identity, quality, purity, potency, and composition of the test article. For HPLC methods, the rationale for the column and conditions chosen should be documented. For discriminating dissolution methods, the choice of media, type of apparatus, and detection method should be given. In all cases, a description or tabular list of unsuccessful approaches should be included. The reason for including such information is to assist the quality unit should it be necessary to redevelop or refine the method after approval due to changes in the process, formulation, or other variables. If and when this does occur, having this information at the disposal of the quality unit will help avoid “redeveloping the wheel” with respect to the analytical methods. A good method development/validation report will include sample chromatograms for approaches that have been tried. For a more detailed discussion of method development and validation, the reader is referred to the chapters in this text by Rasmussen and Crowther, respectively.

B. Analytical Development Report

The analytical development report is a documented summary and logic flow of all essential analytical information acquired during the R&D phase of the project. In many cases, this report serves a variety of purposes: it is a repository of all important analytical information pertaining to the project and is therefore a source document for the quality unit, and it is also used in the preparation of the site inspection at the time of product approval. All information contained in this report must be traceable to raw data and other reports, if applicable. Table 3 contains a summary of all information that should be contained in the analytical development report. The format of the report is not critical, but the information must be present. For further details on the various sections and chapters in this report, the reader is referred to other chapters in this text that describe the details therein.

TABLE 3 Suggested Content of the Analytical Development Report

Section	Content
1. Overview of project	Statement of analytical testing Pertinent background information on test article (summary of synthetic scheme for substance, composition/manufacturing process for dosage form)
2. Summary	Summary of drug chemistry of substance Discussion of potential impurities and degradation products Degradation mechanisms and relevance Preformulation data summary
3. Method history	Development history for key methods Discussion of method changes, additions, deletions Rationale for key methods Reference method development/validation reports
4. Specifications	Rationale for proposed marketed product specifications History of specification setting, tightening, etc. Tables of key batches clearly illustrating justification for proposed specification
5. Stability	Summary of stability behavior, trends, etc. for substance and/or product Reference substance or dosage form stability reports Brief discussion of “probe stability” studies as development pharmaceuticals
6. “Tips and tricks”	Guidance for quality unit laboratories Summary of key ingredients of each method Safety issues/precautions Use of compendial methods
7. References	List of important reports/sections “Partner” reports (chemical development, pharmaceuticals, etc.)

The analytical development report is one of the most valuable documents written by the R&D unit during the development process. If properly composed and completed, it can serve as a powerful document for many years after product approval.

C. Transfer File

Many companies have developed the practice of composing what is termed the “transfer file” as a means of ensuring that all key documents and relevant information are imparted to operations or the receiving laboratory. This file is merely a collection of important reports. For analytical methods, such documents include the method development and validation reports, impurity profiling report, stability reports and tables, and specification archive. The power of such an approach is that it ensures that all information is conveyed to the receiving laboratory. This strategy is useful if operations will be relied on to continue the development process. Examples include development for

new formulation strengths for “brand support” or life cycle management or the support of phase IV clinical trials.

IX. CHAPTER SUMMARY

This chapter highlights the important aspects of the analytical transfer process as they relate to compliance, analytical data, and documentation. Other chapters in this text should be consulted for elaboration on the various important facets of technical transfer, including method development, method validation, documentation, and stability.

REFERENCES

1. McGonigle, E. Assay validation and inter-laboratory transfer. In *Development and Validation of Analytical Methods* (C. M. Riley and T. W. Rosanske, Eds.), pp. 3–13. Elsevier, New York, 1996.
2. Pharmaceutical Research and Manufacturers Association Analytical Research and Development Workshop, Wilmington, DE, September 20, 2000.
3. Scypinski, S., Oates, M., Etse, J., and Roberts, D. PhRMA acceptable analytical practice on technology transfer. Work in progress.
4. Crowther, J. B. International method transfers. Presented at the 1998 Eastern Analytical Symposium and Exposition, Abstract 490, 1998.
5. Crowther, J. B., Jimidar, M. I., Niemeijer, N., and Salomons, P. Qualification of laboratory instrumentation, validation, and transfer of analytical methods. In *Analytical Chemistry in a GMP Environment* (J. M. Miller and J. B. Crowther, Eds.), pp. 453–456. Wiley, New York, 2000.
6. Howard, B. Experiences and expectations for transferring automated pharmaceutical analysis methods in a global pharmaceutical company. In *Proceedings of the 1999 International Symposium on Laboratory Automation and Robotics*, CD-ROM version, ISLAR, Hopkinton, MA, 1999.
7. Kirschbaum, J. J. Inter-laboratory transfer of HPLC methods: problems and solutions. *J. Pharm. Biomed. Anal.* 7:813–833, 1989.
8. Bidlingmeyer, B. A. *Practical HPLC Methodology and Applications*. Wiley, New York, 1992.
9. Ethinyl Estradiol. In *USP 24–NF 19*, pp. 692–693. U.S. Pharmacopeial Convention, Rockville, MD, 2000.
10. Crowther, J. B., Salomons, P., and Callaghan, C. Analytical method development for assay and impurity determination in drug substances and drug products. In *Analytical Chemistry in a GMP Environment* (J. M. Miller and J. B. Crowther, Eds.), pp. 350–351. Wiley, New York, 2000.
11. Kassal, A., Szecsi, A., Koppany, A., Vegh, Z., and Ferenczi-Fodor, K. Analytical transfer of an OPLC purity test and its application for in-process monitoring. *J. Planar Chromatogr.* 13:30–32, 2000.
12. Meier, P. C. and Zund, R. E. *Statistical Methods in Analytical Chemistry*. Wiley, New York, 1993.
13. Taylor, J. K. *Statistical Techniques for Data Analysis*. Lewis, New York, 1990.
14. Anderson, S. and Hauck, W. W. A new procedure for testing equivalence in comparative bioavailability and other clinical trials. *Commun. Statist. Theory Methods* 12:2663–2692, 1983.
15. Vial, J., Jardy, A., Anger, P., Brun, A., and Menet, J. Methodology for transfer of liquid chromatographic methods based on statistical considerations. *J. Chromatogr. A* 815:173–182, 1998.
16. Miller, J. M. The training of pharmaceutical analysts. *Am. Lab.* 32(20):13–19, 2000.
17. Miller, J. M. and Crowther, J. B. *Analytical Chemistry in a GMP Environment*. Wiley, New York, 2000.

This Page Intentionally Left Blank

15

PHARMACEUTICAL ANALYSIS DOCUMENTATION

HITESH CHOKSHI

KATHLEEN SCHOSTACK

Hoffmann-La Roche, Inc., Nutley, New Jersey 07110

- I. SCOPE
- II. INTRODUCTION
- III. PHARMACEUTICAL ANALYSIS DURING PRODUCT LIFE CYCLE
 - A. Discovery: Candidate Screening
 - B. Clinical Candidate Selection
 - C. Phase 0: Preclinical Development/Pre-entry into Humans
 - D. Phase 1: Entry into Humans/Opening IND
 - E. Phase 2: Proof of Concept/Safety Studies
 - F. Full Development Decision Point
 - G. Phase 3: Pivotal Efficacy Trial(s);
Pre-NDA Planning/Development
 - H. NDA: Submission, Approval, and Launch
 - I. Phase 4: Marketing
- IV. REGULATORY DOCUMENTS
 - A. IND Documentation
 - B. NDA Documentation
 - C. Global CMC NDA
- V. COMPLIANCE DOCUMENTS
 - A. General Quality System Documents
 - B. Product-Specific Documents for PAI
 - C. Technology Transfer Document
 - D. Analytical Development Report
 - E. QA Review of Analytical Documents
 - F. Preapproval Inspection Teams
- VI. RESEARCH DOCUMENTS
- VII. SUMMARY
- VIII. CONCLUSIONS
- APPENDIX I: REFERENCES FOR CMC GUIDANCES
 - A. IND
 - B. NDA
 - C. Postapproval
 - D. Compliance
 - E. ICH
- APPENDIX II: U.S. NDA TABLE
OF CONTENTS—ANALYTICAL DOCUMENTATION

I. SCOPE

This chapter describes analytical documentation needs during the life cycle of a pharmaceutical product—from initial candidate screening and selection,

through entry into humans/Investigational New Drug application (IND), to New Drug Application (NDA) and postapproval marketed product support. Most of the information is based on U.S. Food and Drug Administration (FDA) and International Conference on Harmonisation (ICH) guidelines. European Union (EU) requirements are similar.

II. INTRODUCTION

Pharmaceutical analytical data are the foundation and backbone for development and marketing of new drugs. These data are acquired and reported in various ways to demonstrate quality, purity, and stability of an investigational or marketed drug product. The data also serve to bridge changes that occur in synthesis, formulation, and manufacture of a pharmaceutical product from the initial concept through development and postapproval modifications.

The chapter begins with an overview of the life cycle of a new drug and the associated analytical data needed at different stages to support development and marketing. These data are captured in various reports as a combination of

- Regulatory documentation [IND, NDA, biological license application (BLA)] for submission to health authorities
- Compliance [good manufacturing practice (GMP)] reports for inspection
- Internal research and development reports

Many new guidelines concerning the Chemistry, Manufacturing, and Controls (CMC) requirements for pharmaceuticals have been drafted and issued over the last few years. Most concern regulatory requirements for IND and NDA submissions. There are also a number of GMP-related guidelines. Consistent with this trend, the following sections emphasize regulatory documentation with a less detailed discussion of compliance documents. The importance of internal research and development reports is also discussed. Internal reports are becoming more important for capturing the history of a product as requirements for regulatory documentation are reduced. All three types of documents are necessary to capture the history of a product and assure the integrity of the data.

This chapter is not intended as a cookbook. It does not provide step-by-step directions on how to prepare analytical documentation for a perfect IND, NDA, or GMP inspection. However, the information presented on the following pages will aid in identifying the critical documents (and their contents) necessary to attain these objectives. A list of related regulatory guidance and policy documents (FDA and ICH) is provided in Appendix I to assist the reader in locating more detailed information on specific topics.

III. PHARMACEUTICAL ANALYSIS DURING PRODUCT LIFE CYCLE

The life cycle of a new drug is illustrated in Figure 1. As shown, the process consists of sequential phases and milestones. The phases are defined by the

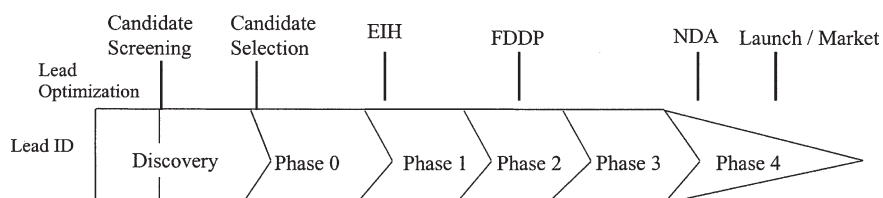

FIGURE 1 Life cycle for new drug development. EIH, entry into humans; FDDP, full development decision point.

stages of preclinical and clinical development leading to market launch. In practice, the development phases are rarely discrete so that only the decision points clearly mark progress.

The activities within analytical research and development progress with the different phases of drug development. The time lines for technical development activities depend on the therapeutic indication and associated clinical and toxicology programs. New drugs with the promise of fulfilling an unmet medical need may have a highly accelerated clinical program. The technical activities will then be compressed and overlapped. For chronic-use drugs, carcinogenicity studies and clinical studies may be on the critical path, providing more time to optimize the technical development.

As shown in Figure 2, analytical documentation comprises a variety of analytical reports. The major types of analytical documentation are frequently

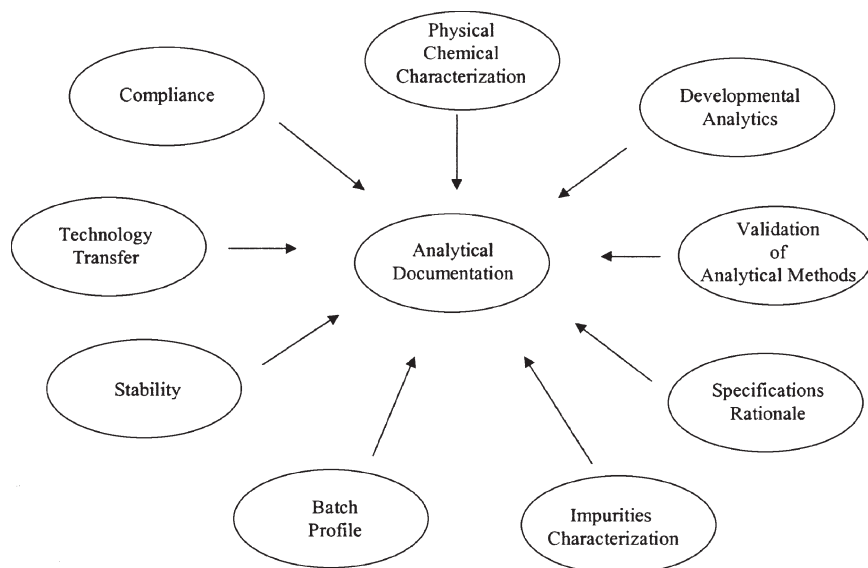

FIGURE 2 Major types of analytical documents.

repeated and/or updated throughout development and during postapproval changes (Table 1). The analytical organization must have scientifically sound and compliant practices and well-defined processes to ensure that these critical reports are prepared in a consistent, timely manner. Because of the repetition during development and from product to product, the analytical group may benefit from developing a template or guideline for each type of report to (1) ensure consistency and completeness and (2) keep up with today's highly accelerated pace for development and production changes.

Critical activities for each development phase or milestone in a new product's life cycle are summarized below. The key analytical support, activities, and associated documentation are described for each phase. The activities are generally applicable but may vary considerably for a particular program depending on the nature of the new chemical entity and the therapeutic indication. The activities are also applicable to line extension products or generic products but will be abbreviated because of the significant body of data available for the original/innovator product.

A. Discovery: Candidate Screening

The primary goal during candidate screening is to rank a large number of compounds based on efficacy in animal models, biopharmaceutical properties (such as solubility and permeability in caco-2 cells), preliminary pharmacokinetic profile in animals, and potential for metabolic and toxicity liability. A non-good laboratory practice (GLP) Ames test may be performed to screen for potential mutagenicity.

Early analytical activities focus on becoming familiar with the chemistry, physical properties, and stability of the new drug substances. The purity of the test material(s) and preliminary solid-state and solution stability results should be established for candidates before use of the Ames test. Candidates are also screened with respect to potential technical issues for further development. Purity and stability testing are performed using a combination of relatively simple chromatographic methods (i.e., high-performance liquid chromatography, thin-layer chromatography, and gas chromatography). A basic solubility profile is developed. Preliminary solid-state characterization is performed using differential scanning calorimetry, thermogravimetric analysis, and X-ray diffraction.

Note that analytical activities for protein pharmaceutical products follow similar principles but use methods for *in vitro* or *in vivo* (animal model) bioactivity, electrophoretic and chromatographic methods, amino acid analysis, peptide mapping, sequencing, etc., for characterization.

Analytical documentation during the discovery phase consists of the following items:

- Biopharmaceutical classification based on solubility and *in vitro* permeability data
- Internal methods—qualified by partial assessment of validation parameters
- First impurity profile

TABLE I Analytical Documentation: Key Product-Specific Documents during Development

Documentation type	Phase 0	Phase I (IND)	Phase II	Phase III	NDA
Physical chemical characterization	Analytical and preformulation report Ideally, rationale for selection of the solid-state (polymorph) and chemical (salt) form	Updated characterization reports linking toxicology and clinical materials	Updated reports to bridge evolution of synthesis	Updated reports to bridge evolution of synthesis Data to bridge supplies	See Appendix II
Analytical methods	Validated analytical methods for drug substance and toxicology formulation; preliminary analytical methods for clinical formulation	Updated reports for API and clinical formulation	Updated reports for API, toxicology and clinical formulations	Updated reports for API, toxicology, and clinical formulations Rigorous validation data	See Appendix II
Batch profiles	Impurity profile for API and dosage forms used for toxicology supplies	Updated batch profiles for API, toxicology, and clinical formulation	Updated batch profiles for API, toxicology, and clinical formulation	Updated batch profiles for API, toxicology, and clinical formulations Data to bridge supplies	See Appendix II
Stability	Short-term (3 months) stability data on drug substance and toxicology formulation	Stability reports for API, toxicology, and clinical formulation (at least 1 month accelerated data)	Updated stability data	Updated stability data Stability plan for registration batches	See Appendix II
Specifications	Proposed specifications for API and toxicology formulations	Proposed specifications for API and clinical formulation	Updated specifications reflecting changes in synthesis and stability profile	Updated specifications reflecting changes in synthesis and stability profile	See Appendix II
Reference standard characterization	Characterization and COA	Characterization and COA	Characterization and COA	Characterization and COA NDA reference standard	See Appendix II
Technology transfer	If applicable, e.g., CRO testing	If applicable, e.g., CRO testing, other site	If applicable, e.g., CRO testing, other site	If applicable, e.g., CRO testing, other site	If applicable, e.g., CRO testing, other site
Certificate of analysis/analytical profile	API and toxicology supplies	API, toxicology, and clinical supplies	API, toxicology, and clinical supplies	API, toxicology, and clinical supplies	API, toxicology, clinical, registration, validation supplies

Note: API, active pharmaceutical ingredient; COA, certificate of analysis; CRO, contract research organization.

- Short-term solid-state and solution stability
- Stability data for formulations used in efficacy and pharmacokinetic studies in animals

B. Clinical Candidate Selection

Usually, one or two compounds are selected from the candidate screening and evaluated further in at least one rodent and one nonrodent species for gross toxicity (i.e., 1–2 weeks of dosing). The first real technical challenge is development of a toxicology formulation, which will provide adequate exposure in animals—generally several times higher than the expected dosing per body weight in humans. The decision to formally begin entry into human (EIH) enabling studies for the selected new chemical entity depends on a favorable safety profile from these short-term animal studies. The analytical group supports the toxicology program while expanding its knowledge of the compound.

Additional preformulation and physicochemical characterization of the candidate compound are performed and stress stability studies may be initiated. Ideally, the optimal solid state (polymorphic) and chemical (salt) form of the molecule are identified as part of clinical candidate selection. Selection of the most stable and bioavailable form will expedite subsequent development. The methods for testing the drug substance are refined and additional methods may be developed.

Analytical methods for assay of the toxicology formulations and cleaning validation are developed and validated in preparation for the first GLP studies. Release and stability testing of the toxicology test articles are performed to support the suitability of the materials through their anticipated period of use. Typically, short-term accelerated stability studies are performed on the toxicology batches for at least 3 months to cover the time from date of manufacture through the last dose.

Analytical documentation at the clinical candidate selection milestone may consist of the following items:

- Preliminary analytical and preformulation profiles
- Rationale for selection of solid-state and chemical form
- Revised and new internal methods—qualified
- Impurity profiles for new batches, comparison to previous (Ames) batch(es)
- Analytical profiles or certificates of analysis for drug substance and toxicology test articles
- Short-term stability of toxicology test articles

C. Phase 0: Preclinical Development/Pre-entry into Humans

After candidate selection, planning for EIH becomes the focal point of the team's efforts with emphasis on development, manufacture, and release of clinical materials. A formal product development team may be formed and a development plan is prepared to define the target profile for the successful candidate and criteria to be used to assess progress toward that profile.

During phase 0, the analytical research and development group continues to learn about the chemistry and stability of the new compound and supports ongoing toxicology studies. Analytical support for toxicology studies includes GLP studies with additional species and/or longer exposure (i.e., at least 2–4 weeks of dosing) as well as the GLP Ames, safety pharmacology, genotoxicity, and pilot teratology studies. Additionally, the formulations group begins to develop a clinical formulation suitable for EIH, requiring extensive analytical support for excipient interaction studies and stability studies of prototype formulations. The clinical formulation for EIH is selected based on satisfactory stability data and, preferably, a bioavailability study in a suitable animal model. The animal bioavailability study is performed to assist in predicting bioavailability in humans.

Analytical methods continue to be improved while changes in the synthesis or quality of the drug substance are evaluated. The preferred methods of analysis are identified. The analytical methods are qualified using selected validation criteria and data are compiled for establishing IND specifications for clinical materials.

Analytical documentation during phase 0 to enabling EIH generally consists of the following items:

- Updated analytical and preformulation report of drug substance—summary of physical and chemical properties
- Reference standard characterization
- New and revised internal methods (for cleaning validation; release and stability testing of drug substance and toxicology formulations)
- Analytical method validation summaries/reports—qualification of methods for GLP toxicology studies
- Impurity profiles for new batches and comparison to previous toxicology batches
- Certificates of analysis—drug substance
- Analytical profiles or certificates of analysis for toxicology batches
- Analytical testing data for in-life toxicological study samples (homogeneity, periodic testing, and end-of-study)—the testing of samples from the animal dosing site required as per GLP
- Ongoing stability of toxicology test articles or stability studies of new toxicology formulations
- Preformulation and prototype formulation studies for clinical formulations

D. Phase I: Entry into Humans/Opening IND

Phase 1 clinical trials include introduction of the investigational drug into humans. The studies may be conducted in patients or normal subjects. They are designed to determine the side effects associated with increasing doses and, if possible, to gain early evidence of effectiveness. Phase 1 studies also include research into drug metabolism, pharmacokinetics, and mechanism of action in humans. Total phase 1 exposure is generally in the range of 20–80 subjects.

An IND application must be submitted to the FDA before the first clinical trial in the United States. A regulatory submission may not be required outside of the United States if the study is conducted in volunteers. For IND EIH studies, the project team must plan for the manufacture and release of clinical trial materials as well as for the IND documentation. For a study in volunteers not requiring an IND, documentation needs are reduced but all other activities remain the same.

Within the analytical research and development (R&D) unit, specifications and methods for clinical trial materials are approved and results from short-term stability evaluations are reported. Method validation is completed for critical validation parameters for those methods used in release and stability testing of the clinical materials. Impurities and degradation products are tabulated for the toxicology and clinical batches to assure the safety of the materials for human use.

The primary analytical mission at this stage is to ensure that adequate documentation for quality, consistency, and stability of the clinical materials is available to bridge the drug development as safely as possible from animals to humans.

IND-enabling analytical documentation includes the following items:

- Characterization of the reference standard for purity, impurities, physical-chemical properties related to bioavailability
- Rationale for selection of polymorphic and salt form, if applicable
- Batch profile—toxicology and clinical batches
- Supporting information for known impurities, degradation pathways, and products
- Rationale for the IND specifications (drug substance and drug product)
- Specifications (test, limits, and methods) for drug substance and drug product(s), including placebo (release and retest/stability, if different)
- Methods qualification/validation for methods included in IND specifications
- Stability data
 - Available data from stress studies of drug substance
 - Available data from accelerated (generally at least 1-month) and long-term studies of clinical formulation(s)
- Certificates of analysis for drug substance and drug product to be used in the clinic

E. Phase 2: Proof of Concept/Safety Studies

Phase 2 trials are the early controlled clinical studies conducted to evaluate the dose ranging and effectiveness of the drug for a particular indication in patients with the disease and to determine common short-term side effects and risks associated with the drug. General exposure is usually less than several hundred subjects.

Many of the phase 2 activities are simply a continuation of studies initiated during phase 1. Previously, this was a relatively quiet period in the development life cycle. More recently, the respite is short-lived, if at all. The accelerated pace

of development has compressed all aspects of drug development, and the pace rarely slows down. There is no slowing of activities if the FDA designates a compound for fast track development. Phase 2 regulatory activities often include an end of phase 2 (EOP2) CMC strategy meeting with FDA to discuss and obtain concurrence on plans for registration activities and development toward a NDA.

Analytical support is needed for development and optimization of the registration process and potential commercial formulations. Methods may need to be revised in line with changes to the synthesis or formulation. Analytical methods are further optimized for analytical purposes. Changes to the procedures may necessitate (re)validation. Also, characterization of the drug substance continues. Evaluation and control of stereochemistry (for stereoisomeric compounds) and/or potential solid-state forms (e.g., hydrates, solvates, or polymorphs) remain critical concerns. Release and stability testing continues for long-term GLP studies, including carcinogenicity studies, if required, and for ongoing clinical studies.

Analytical documentation during phase 2 includes IND amendments and internal development reports:

- Identification of new impurities or degradation products
- Revised specifications and methods of analysis (including analytical improvements as well as new synthetic routes/processes and new formulations)
- Stability updates/reports
- Certificates of analysis for drug substance batches and clinical supplies

F. Full Development Decision Point

Results of the phase 2 trials form the basis for a firm's decision to proceed with full development. The full development decision is critical because it results in commitment of money and resources for the larger, longer-term clinical trials required for marketing approval. The additional money and resources required for initiation of CMC registration activities are equally critical. This involves manufacture of registration batches of drug substance and drug product for NDA/BLA submission. Major capital expenditures are often required at this time for the manufacturing sites to produce the required registration batches.

G. Phase 3: Pivotal Efficacy Trial(s); Pre-NDA Planning/Development

Phase 3 studies are performed after evidence of the effectiveness of the drug has been obtained. These are expanded clinical trials intended to gather additional data regarding safety and effectiveness, as well as to determine the risk–benefit relationship of the drug. Phase 3 studies may include a range from several hundred to several thousand patients. Often a bioequivalence (BE) or bioavailability (BA) study is included to demonstrate comparability of the proposed market formulation to the clinical formulation(s) used in the previous safety and efficacy studies. Plans for NDA preparation are initiated in anticipation of favorable clinical results from the phase 3 trials.

The analytical R&D unit is a central participant in the various phase 3 activities. Testing and release of clinical trial materials (drug substance and product) continue, including supplies of the proposed market formulation for a BA/BE study to compare with the previous clinical trial formulations. Also, extended physical and chemical characterization are performed for the registration batches (drug substance and product) to demonstrate technical equivalence of the proposed market product and pivotal clinical formulation(s). Long-term stability studies of previous clinical formulations continue. Accelerated and long-term stability studies of the registration batches are initiated.

Typically, a pre-NDA meeting is held with the FDA to gain concurrence on the content of the NDA. The firm provides an update on progress against issues discussed at the EOP2 meeting—closure or additional work to be done. Analytical data are presented to link materials used in toxicology studies, human dose ranging, pivotal, and bioequivalency studies. The most critical links from the safety and equivalency perspectives concern the data for purity/impurities, stability, and *in vitro* product performance (e.g., dissolution). It may be necessary to obtain agreement that the available data are adequate and no further *in vivo* comparison is needed. Often a firm will propose submitting less than 12-month stability data in the original NDA, with an update provided during the review period, to move up the filing date and accelerate the approval date.

Draft documents for the NDA are needed during phase 3 both for the pre-NDA meeting and for compilation and team review of a draft of the CMC section.

Documents required for the pre-NDA meeting include the following items:

- Pre-NDA meeting briefing package
- Draft NDA documents
 - Drug substance
 - Nomenclature, formulas and proof of structure
 - Physical/chemical characterization
 - Stability—stress, accelerated, long-term; storage, retest/expiry
 - Comprehensive summary table for batch profiles
 - Specifications—methods, tests, limits, rationale, validation
 - Drug product
 - Stability—accelerated, long-term (stress studies generally not performed for drug product)
 - Comprehensive summary table for batch profiles
 - Specifications—methods, tests, limits, rationale, validation
 - Batch tracking—drug substance and product

An expanded table of contents for the NDA is provided in Appendix II.

Note that protein pharmaceutical products require extensive biochemical and bioactivity comparability studies for materials used for toxicology, clinical, and proposed market supplies.

H. NDA: Submission, Approval, and Launch

The final development milestones for a new pharmaceutical product are the submission and approval of the NDA and product launch. During this stage,

the team must finalize all NDA studies (preclinical, clinical, and technical) and study reports. The documents are compiled and the original NDA is submitted to the health authorities for review. Some studies continue after NDA submission. Updated reports may be submitted during the review period or prepared and kept at the company in anticipation of questions. Prior agreement may be needed from the health authorities to permit submission of amendments during the review period.

In addition to the NDA documentation, the technical areas must prepare for preapproval inspection (PAI) and validation for launch. Special development reports may be written to provide a comprehensive summary of the development history in a given technical area for PAI. Other documents (e.g., investigation reports and certificates of analysis) are simply assembled for easy retrieval. Protocols and final reports are prepared for validation and technology transfer. Thus, the required documentation for NDA filing includes all documents explicitly listed in the NDA table of contents as well as additional compliance and research reports to support investigations and decisions.

During the review period, any of the CMC sections may be revised in response to comments from the review chemist or field inspector. Responses may include postapproval commitments for additional work or data updates. For a globally marketed product, comments will be received from individual health authorities over a period of time—often extending for years. Changes in response to comments from the health authorities for one country may necessitate overall changes if a firm wishes to harmonize internal requirements and keep a single dossier. As a result, the approval and launch period has a very hectic pace, tapering as additional approvals are received but continuing over an extended period of time.

Analytical documentation for NDA and PAI consists of the following items:

- Finalization of all documents for the CMC section of the original NDA submission (listed above and in Appendix II)
- Compliance documents for PAI
- Revision/update of NDA documents in response to comments by regulatory authorities
- Change control, if needed

I. Phase 4: Marketing

Often even before the first marketing approval, firms begin planning extensions and alternate supplies for market. New indications, line extensions, and/or postapproval supply changes are considered and possibly initiated before approval. Line extensions may include new formulations for other routes of administration or more convenient dosing regimens. Development of pediatric formulations in pursuit of additional exclusivity in the United States has been a major area of activity. Similarly, a geriatric indication is becoming more important. Clinical trials for new indications do not require support from the technical team. However, those that involve new formulations require extensive CMC support. These changes may result in a supplemental NDA (sNDA) but often involve a new NDA for a new dosage form.

Analytical documentation for an sNDA or a new NDA is the same as that for the drug product of the first NDA. Additionally, comparative data may be needed to illustrate the similarities or differences versus the reference marketed product.

Analytical documentation for sNDA or NDA for line extension consists of the following items:

- Drug product
 - Stability—accelerated, long-term (stress studies generally not performed for drug product), statistical analysis
 - Comprehensive summary table for batch profiles
 - Specifications—methods, tests, limits, rationale, validation

The postapproval period is also very active when there are changes in manufacturing sites, processes, or controls. All of these changes should be managed globally via the firm's change control system. All changes require supportive analytical data, generally associated with demonstrating equivalence with the approved material so that analytical documentation for postapproval changes is specific to the type of change.

IV. REGULATORY DOCUMENTS

Although the phases in the life cycle of a new drug are sequential, the process for preparation of regulatory documents for IND and NDA submission is not linear. Most of the development activities overlap so that the associated documentation is highly interdependent. The biggest efforts related to regulatory documentation are concentrated around the opening IND and the NDA. Planning and preparation for these and other critical regulatory submissions are necessary to meet development timelines. NDA planning is especially critical to ensure on-time completion of a quality dossier. In all cases, authors must collaborate closely with other contributors to ensure completeness, consistency, and accuracy of the regulatory documentation.

Throughout drug development, the analytical group works on multiple tasks simultaneously (e.g., method development or optimization and validation, release, and stability testing). Most of the tasks are interrelated so that changes in one study or report may necessitate changes within others. The group needs to ensure integration and consistency across related documents—within and external to the analytical sections. Regulatory updates are prepared periodically or after changes to the drug substance or clinical formulation.

Although some documents are required only for NDA submission, the major types of analytical reports for regulatory submission are very similar for IND and NDA submissions. The differences in these reports for IND or NDA submission primarily concern the amount of data (e.g., number of batches, duration of stability studies) and level of detail. Also, the requirements for amendment of the information are different. The major types of analytical documents common to IND and NDA submissions are the following:

- Drug substance
 - Physical–chemical characterization
 - Reference standard characterization
 - Specifications and analytical methods
 - Certificates of analysis
 - Methods validation
 - Stability (stress, accelerated and long-term conditions)
- Drug product
 - Specifications and analytical methods
 - Certificates of analysis
 - Methods validation
 - Stability (accelerated and long-term conditions)

The analytical concerns and activities that support IND and NDA submissions are described in the following sections. Specific requirements on content and format for U.S. regulatory documents are contained in numerous FDA guidances. Certain global requirements are captured in the ICH quality guidelines. Because global development and marketing are becoming the norm for many companies, a modular approach for preparing a global CMC NDA is also described. A list of the most frequently used guidelines and a generic table of contents for a U.S. NDA are provided in Appendices I and II.

A. IND Documentation

Under current U.S. regulations, any use of an investigational drug product first requires submission of an IND to the FDA before clinical trials in humans are conducted. The sponsor provides short-term animal toxicity testing data to predict whether initial human studies will be acceptably safe and, if possible, the drug's expected therapeutic activity. Once an IND is filed with the FDA, the sponsor must wait 30 days before initiation of clinical studies. During the 30-day waiting period, the FDA reviews the submission to ensure that human subjects will not be subjected to unreasonable risks. Testing in humans may begin if no comments or questions are received from FDA within the 30-day review period. Clinical testing proceeds progressively through phases 1, 2, and 3, where each phase is more extensive than the previous phase with respect to the number of subjects and duration of treatment.

Typically, an opening IND is submitted before the first clinical study for EIH. As more firms undertake global development, EIH studies may be performed outside of the United States. An IND may not be required if the first clinical trial(s) are performed outside of the United States with volunteer subjects. The U.S. IND must still be filed before the first use of the investigational drug product in the United States but may begin with phase 2 clinical studies.

I. Enabling Preclinical Studies

Throughout drug development, preclinical animal studies are used to predict and assure the safety of human clinical trials. The preclinical program proceeds ahead of the clinical program to provide the necessary safety/toxicity information in a timely manner. The sponsor must relate the drug product

being proposed for use in clinical studies to material used in the preceding animal toxicology studies that support the safety of the proposed human study. This is often done for the IND using a batch-tracking table. The table lists the toxicology and clinical batches manufactured to date with a summary of the analytical data related to safety and bioavailability (i.e., purity, impurities, and certain physical and chemical characteristics). Additionally, chemistry or manufacturing differences between the toxicology and clinical materials should be described and the potential impact of the differences on the safety profile should be discussed.

2. CMC IND Information

The CMC information for an international IND is similar to that required in the United States. The IND must include sufficient CMC information to ensure the proper quality, identity, purity, and strength of the investigational drug for the planned clinical trial. The type and extent of information submitted to the IND depends on the clinical phase of the investigation with respect to the size of the study and duration of treatment, the dosage form, and the amount of information available. Considerations in the CMC data to be submitted concern the nature and source of the drug substance and the clinical dosage form. The methods of preparation of the new drug substance and dosage form are expected to be modified as the clinical investigation progresses. Updates and revisions of the CMC section during clinical trials (e.g., manufacturing process, formulation, or specifications) should be submitted to the IND in information amendments and annual reports.

Following enactment of the Prescription Drug User Fee Act, the FDA issued a guidance on content and format of INDs for phase 1 studies (issue date November 1995). More recently, a draft guidance on content and format for CMC information required for INDs for phases 2 and 3 studies was distributed for comment (February 1999). These guidances restate current regulations, emphasizing the progressive nature of CMC information, and clarify the data to be included in the IND based on the phase of development. The recommendations in the IND guidances focus on information for evaluation of the safety of the subjects in the proposed study. Recommendations are also provided for supplementary data and information for the phase 3 pivotal study that corroborate the quality and safety criteria. The IND guidances are intended to expedite drug development and entry into the marketplace while ensuring that the FDA has sufficient data to assess the quality of the clinical trial materials and the safety of the proposed clinical studies from the CMC perspective.

The emphasis in the IND for phase 1 studies is on the identification and control of the new drug substance. As clinical development progresses, additional information should be submitted for new processes and larger-scale manufacturing procedures used to produce materials for the phase 2 and phase 3 clinical trials. Information for phase 1 studies may be submitted in a summary report with *brief* descriptions. The summaries are expanded and data are added as development and clinical trials progress. For example, established specifications and method validation need not be submitted for phase 1, but a detailed listing of all tests with a complete description of the corresponding procedures with validation information is expected by phase 3.

Required analytical information for IND includes the following items:

- Description and physical and chemical characteristics of the drug substance
- Evidence of the proposed structure
- Test methods and “proposed acceptable limits” for the clinical trial materials
- Analytical data and certificates of analysis
- Stability study and test methods used to monitor stability of the drug substance including preliminary stability data for representative material

3. IND Meetings

In the United States, the FDA provides firms with opportunities to discuss technical issues directly with the review division. These meetings, scheduled at key development milestones, are critical to the effective development of a new drug product and to the timely submission and approval of the product for market. A recent draft guidance formalizes CMC IND meetings including pre-IND, EOP2, and pre-NDA (or pre-BLA for biological products). These meetings can be used to address questions and scientific issues that arise during the course of the technical development. The discussions are intended to aid in resolution of problems and to facilitate evaluation of new drugs. Procedures for IND meetings are described in the guidance.

The pre-IND meeting is intended to discuss safety issues related to the investigational drug and to identify and avoid potential clinical hold issues. Reasons for a clinical hold are identification of a safety concern or insufficient data to make an evaluation of safety. Safety concerns related to CMC arise when the physical–chemical characteristics or the impurity profile of the clinical trial material is insufficiently defined so that the potential health hazard cannot be assessed or the product cannot remain stable through the proposed clinical study. Pre-IND meetings are most useful for biotechnological drug products, novel dosage forms, or drug–device combinations.

The EOP2 meeting provides a firm with an opportunity to discuss their plans and protocols for phase 3, NDA, and market. A CMC-specific EOP2 meeting is held principally as a CMC strategy discussion. It is the most critical IND meeting for planning the CMC portion of the NDA. The goal of the meeting is to identify potential problems that may delay marketing approval at a sufficiently early stage to avoid or minimize their impact on approval. Typical discussion points concern reduced stability protocols for registration batches; bridging strategies for clinical, registration, and commercial materials; proposed NDA specifications; and other product-specific development problems. The outcome of a successful EOP2 meeting is a clear understanding of the CMC data needed for an approvable NDA.

The pre-NDA/BLA meeting is intended primarily to identify and resolve potential filing or approval issues. Other goals are familiarization of FDA reviewers with the product to facilitate review of the NDA, update on progress or changes since the EOP2 meeting, and discussion of site readiness for inspection. Often, the firm will propose a reduction in the amount of stability data at filing, with a commitment to update during review, to move up the filing date. The meeting is critical to ensure submission of a complete NDA/BLA.

B. NDA Documentation

NDA preparation requires extensive planning and coordination among authors to ensure consistency and completeness of the dossier. Analytical data are the common thread in all CMC documents and are highly intertwined with other reports in the CMC section. Documents related to biobatches also need to be integrated between the CMC and clinical sections of the NDA. The value of cross-functional review of documents cannot be overemphasized. If possible, review of the complete CMC section by the CMC team or an independent technical reviewer is highly recommended.

The ICH requirement for 12-month stability data in the NDA submission has two major effects on the technical planning and NDA:

1. The physical registration work (i.e., manufacture of registration batches) is often completed early in phase 3. In principle, the related documents can be written shortly thereafter. In practice, most documents are not written until shortly before filing.
2. The U.S. Application Summary, EU Expert Report, stability reports, and drug product specifications will frequently define the time-critical path for NDA filing. These documents may be prototyped based on data from clinical batches and available data from registration batches. They cannot be finalized until the last stability data points are reported.

The NDA must contain information that establishes the linkage between dosage forms used in clinical trials and that intended for the commercial product. The firm must demonstrate that changes in drug substance or drug product during scale-up for market has not affected the safety or bioavailability/bioequivalency of the dosage form. The linkage can be made using *in vivo* and/or *in vitro* data (e.g., impurity profiles or dissolution profiles). By the time the NDA is compiled, data should have been assembled to support the safety and bioavailability of the proposed market product relative to the clinical materials from the primary efficacy study(ies). Additionally, data for the registration batches should demonstrate the consistency of the proposed commercial process and the quality and stability of the drug substance and drug product to be marketed.

Specifically, the CMC section of the NDA should have data to support the following statements.

For drug substance: The synthesis (i.e., chemistry and process) is understood and well controlled. Appropriate controls have been established for the raw materials, starting materials, and in-process tests to ensure that the process can consistently produce drug substance of high specific quality. Appropriate release and retest specifications (methods and limits) have been established based on data from development lots (clinical and registration) to assure the identity, quality, and purity of the material. The impurity profile for registration batches is equivalent or superior to batches used in toxicology or clinical studies—all significant impurities have been qualified at the specified levels in preclinical or clinical studies. Physical characteristics are controlled, if needed, to guarantee manufacturability and bioavailability for the dosage form. The quality of the drug substance is maintained under the recommended storage conditions through the proposed retest period.

For drug product: The proposed market formulation is bioequivalent to investigational materials used in the pivotal clinical trial(s). The drug product manufacturing process is understood and controlled. Appropriate process parameters and in-process controls ensure that the process can reproducibly produce drug product of high specific quality. Appropriate specifications (release and stability, if applicable) have been established for the excipients and finished drug product. The stability profile of the proposed market formulation is equivalent or superior to that used in toxicology or clinical studies. Degradation products have been qualified at the specified limits in preclinical or clinical studies. Stability data on registration batches support the proposed expiration date.

The analytical group produces all of the CMC documents that support the above messages. The support is derived mostly from bridging analytical data that demonstrate technical equivalence between the proposed market formulation and the clinical formulation(s). Technical data from analytical comparability studies or *in vivo* bioequivalence studies can be used to demonstrate equivalence after synthesis, formulation, packaging, site, and/or process changes.

Bioavailability (and related toxicity) issues are addressed in the physical-chemical characterization of the drug substance, the solid-state form of the drug substance (rationale for selection and comparative physical-chemical characteristics), particle size controls, and/or dissolution data for solid oral and suspension dosage forms. Other safety issues concern purity and impurities of the drug substance and drug product. Consistent or improved purity is demonstrated by the batch-tracking summary, which compares the impurity profile during development to material from the registration process. It is finally assured by the proposed quality controls. In making this case, the discussion of the quality controls should include explicit remarks regarding the choice of routine tests and limits as well as the rationale for the controls and qualification of specified impurities.

The stability of the proposed market product is preferably demonstrated first by satisfactory results for the primary registration batches under accelerated and long-term storage conditions. Alternately (or additionally), the stability profiles for the primary registration batches can be compared to those for supportive development batches for which longer real-time data may demonstrate stability over prolonged storage. Stability assurance is also demonstrated by a good understanding of the degradation pathways and products determined during stress stability studies.

C. Global CMC NDA

Efforts are currently under way within the ICH to develop a common technical document (CTD), thereby harmonizing the CMC regulatory requirements for global development and marketing. Although some progress has been made with respect to a harmonized table of contents, much remains to be done to harmonize the format and contents of the global NDA. Some assistance/recommendations are provided by the existing ICH quality guidances, until more common areas are developed within the CTD.

Preparation of the CMC sections according to EU and U.S. guidelines results in two formally different NDAs. The contents of the CMC sections of the EU and U.S. NDAs are very similar. However, the sequence and titles of the sections are quite different. Because of the similarity in content, a modular approach may be used to create a global NDA. The CMC section for a global NDA will consist of a complete set of modules in which each module is global in its contents, i.e., containing the information required in both regions. Some additional country-specific documents (e.g., Application Summary, Environmental Assessment, and Method Validation package for the United States and Expert Reports for EU) still need to be prepared but many of the other technical reports may be suitable for both dossiers by simply reordering. The final EU or U.S. NDA will consist of a specific arrangement of the modules with the appropriate (country-specific) headings. This modular approach reduces the redundancy and effort in preparing the documents.

V. COMPLIANCE DOCUMENTS

Compliance documents refer to those reports required by GMPs and/or utilized during the course of inspection by a health authority. Compliance documents are needed in addition to the regulatory and research documents to demonstrate integrity of the data. A good foundation for the compliance documents begins with well thought out and established quality and compliance systems and practices within an organization. A team, consisting of representatives from R&D, quality control (QC) and quality assurance (QA), develops these systems. It should be one of the top priorities of management and the QA unit(s) to develop and monitor these systems to comply with the current GMP (cGMP) and GLP expectations.

Both general (GMP) inspections and product-specific PAIs focus on documents related to the quality systems and the product-specific controls and integrity of the analytical data. The main difference between the two types of inspections is the emphasis: general GMP inspections begin with an audit of the underlying quality systems and standard operating procedures (SOPs), evaluating selected product-specific data as representative of compliance to those systems. PAIs initially concern the product-specific data and then evaluate some aspects of the quality systems to gauge overall compliance with GMPs.

Typical analytical compliance documents are discussed in the following sections.

A. General Quality System Documents

These documents include the following items:

- SOPs
- Investigation procedures—required for out-of-specification (OOS) results and product failures
 - Preliminary laboratory investigations or work sheets—required for authorizing reanalysis

- Tracking system
- Training records
- Equipment maintenance and qualification (installation qualification/operation qualification/performance qualification)
- General marketed stability protocol
 - Sampling of batches
 - Testing in accord with protocol
- Methods validation
- Validation of stability chambers
- 21 CFR Part 11 validation of data acquisition system and laboratory information management system (LIMS)
- Sample tracking and storage
- Reference standard control
- Contract research organization audits and qualification

B. Product-Specific Documents for PAI

These documents include the following items:

- Analytical development reports—drug substance and drug product
- Investigation reports—required for suspect and OOS results and product failures
- Certificates of analysis for all toxicology and clinical supplies
- Batch profiles—bridging preclinical, clinical, registration, and validation batches, if available
- Reference standard characterization
- Stability reports and updates—drug substance and drug product (registration, clinical, and toxicology)
- Specifications—IND and NDA
 - Method validation
 - Rationale
- Cleaning validation

C. Technology Transfer Document

The technology transfer document is one of the most reviewed types of documents during an inspection. Responsibilities for analytical support of a new drug are often transferred to other sites or other departments. Typically, there will be at least one transfer between the analytical research and development group at the development site(s) to the quality control unit at the launch site(s). Other technology transfers may arise because of the firm's functional organization or changes in supply strategy. The development history and knowledge must accompany the transfer in responsibilities.

D. Analytical Development Report

It is extremely beneficial to have comprehensive analytical development reports describing the evolution of the analytical methods for a new drug substance or

drug product. Separate reports are prepared for the drug substance and product. The reports trace the chronological history of the IND specifications up to the proposed NDA specifications, itemizing changes in tests, specifications, and methods associated with major revisions. Additionally, the development of key methods used to assure identity, potency, purity/impurities, and performance (e.g., particle size or dissolution) should be discussed in detail. Summaries for the critical methods should explain the rationale for the selected method, reasons for changes made during development, and the equivalency or superiority of the final, optimized methods. Ultimately, the development reports should collect the pivotal analytical data which demonstrate that the quality of the drug substance or product and the associated controls have been established logically and rationally.

The contents of the analytical development report should specifically address the following items:

- Choice of routine tests for determining identity, purity, critical physical characteristics, or performance of the drug substance or product
- Additional/informational tests used during development
- Rationale/supporting data for exclusion of tests from routine quality control for commercial product
- Basis for specification limits (including batch history and qualification of specified impurities)
- Rationale and development of analytical methods
- Validation of proposed methods

Additionally, two key issues to be discussed in detail are the following:

- Impurity profile of the drug substance or drug product
- Dissolution profile for the dosage form (if applicable)

Both the impurity and dissolution profiles must be shown to be consistent throughout development, or additional preclinical or clinical studies may be needed to bridge the differences. The impurity profiles must be carefully monitored and controlled batch to batch and especially after changes to the process or formulation. Significant changes in the impurity profile may affect the acceptability of prior preclinical and clinical data. When significant changes occur in the dissolution profile, a bioequivalence study may be needed to demonstrate equivalence of the dosage forms.

Analytical development reports are not part of the NDA. They are primarily internal documents. The analytical development report serves both as a key reference document during inspection by health authorities and as a document to facilitate technology transfer between departments and/or sites. After marketing approval, these reports may also provide a retrospective history of the methods for use by the QC laboratory. To maximize its utility, the development report should provide a thorough summary of the data assembled during the development, including results of successful and unsuccessful experiments leading to the final controls. Emphasis should be placed on *critical* evaluations and conclusions for changes made during development. All data in the report should be fully referenced. References should include previous research reports, journal articles, patents, laboratory notebooks, etc.

E. QA Review of Analytical Documents

The role of the QA group in review of analytical documents (like all critical compliance documents) is to ensure that data are accurate and complete and meet all applicable cGMP and GLP regulations. The extent of QA review, audit, and/or approval of analytical documentation depends on the company philosophy and organization. Regardless of a firm's policy for QA oversight, early involvement by the QA group is becoming more routine because of increased awareness of compliance requirements in the industry and tighter regulatory standards for both clinical and commercial materials.

Key documents that explicitly require review and approval of the QA unit are the following:

- Certificates of analysis
- Investigation reports
- SOPs
- Analytical change control
- Technology transfer protocols and reports
- Software (e.g., data acquisition or LIMS) validation protocols and reports

Other documents, which are reviewed or audited, though not necessarily approved by QA, include the following:

- Specifications and analytical methods
- Methods validation protocols and reports
- Stability reports
- Characterization reports
- Preliminary investigation worksheets/laboratory investigations
- Instrument qualification and validation documents
- Laboratory notebooks

A close partnership with the QA unit assists with establishment of quality systems that are consistent and compliant across departments or sites. QA oversight of the documentation facilitates responses to questions during inspection by health authorities and helps to assure a favorable outcome.

F. Preapproval Inspection Teams

PAI teams may be formed up to 18 months before the targeted NDA filing date. The team is cross-functional with representatives from R&D, QA, Drug Regulatory Affairs (DRA), and manufacturing to assess the risks specific to the quality and approvability of a new product. The PAI team assists the project team to develop plans to assure approval of a safe and quality product for the marketplace.

QA personnel with the help of analytical members of the PAI team audit the following product specific documents:

- CMC NDA documentation and supporting data (preferably before filing to ensure that all data and reports to be submitted in the NDA are accurate and complete)

- Laboratory notebooks and certificates of analysis for reference standards, clinical and registration batches, etc.
- Updated stability reports
- Technology transfer reports for drug substance and drug product
- Specifications and analytical validation (including raw materials, packaging components)
- Available analytical data
- Laboratory investigations and investigation reports
- Cleaning validation

The above checklist is not all-inclusive and a product-specific checklist should be compiled by the PAI team to assist in preparation for a preapproval inspection.

VI. RESEARCH DOCUMENTS

Research reports are a firm's internal mechanism for recording critical events in a product's history. An established mechanism for recording and archiving significant information is usually extremely useful in light of inevitable turnover of people and projects during the discovery and development phases. Other key advantages of a good documentation system for research findings (positive or negative) is for information sharing between projects and for help in decision making or planning for next steps.

Internal summary reports and formal proposals for management are often assembled in preparation for development milestones (e.g., candidate selection and full development decision). Research reports for critical data are written for products as they progress through development. However, reports for failing studies or discontinued programs are often not prepared and these can be equally useful since history tends to repeat itself. Because of the time and resources required to prepare such reports, a conscious decision should be made if the value added warrants the effort.

Research reports are also emphasized in early development before regulatory documentation is required. However, recent changes with respect to reductions in the documents and extent of data that must be provided in IND submissions are increasing the importance of internal documentation through early clinical development (i.e., phases 1 and 2). Specifically, FDA guidances on IND CMC requirements have reduced the amount of data required for inclusion in the IND. Summaries are often allowed in lieu of detailed data. However, from both a compliance and historical perspective, it is critical to collect these data in a report for future reference. Thus, the documentation requirements overall have not been reduced but have been removed from the regulatory submissions and added to the in-house archives.

Typical research documents include the following items:

- Preformulation reports
- Analytical profiles
- Special technology
- Evaluations of experimental prototype formulations

- Milestone reports and management proposal documents for positive or negative decisions
- Research reports containing critical data needed for future regulatory needs

VII. SUMMARY

Pharmaceutical analytical documentation ensures the identity, purity, stability, and consistency of drug substances and dosage forms used during investigational studies and for the commercial market in accord with the regulatory guidances and policies of the governing body. Before marketing approval, analytical research and development personnel support product development and optimization activities. The data and documentation evolve in parallel with the clinical development of the product. Safety is the primary concern throughout the development phases, and the analytical data provide the necessary assurance of safety based on bioavailability, purity, and stability. These analytical data become a critical part of the NDA for marketing authorization. After marketing approval, quality control personnel provide the data to assure consistent quality and stability for the marketed product and to support the inevitable changes that occur in every product's life cycle.

There are three major types of analytical documentation prepared to support investigational and marketed pharmaceutical products:

Regulatory—documents required for IND, NDA/BLA and postapproval supplements.

Compliance—including GMP documents (e.g., validation reports, investigation reports, and annual product reviews), internal reports (e.g., technology transfer reports), and special development reports (summarizing history of product or chronology of critical issues).

Research—usually prepared to record or transfer product history (e.g., analytical profiles), additional informational studies, non-GMP batch issues and investigations.

All three types of documents are necessary to provide a complete history of a product. The regulatory requirements are well established by FDA guidances and ICH guidelines. Similarly, basic compliance requirements are also described in regulations and guidelines. However, a firm's internal policies and procedures establish the requirements for research reports. Because of recent changes in reporting requirements for regulatory submissions, the research documents are becoming increasingly important to record the history and decisions within the life cycle of the product.

Pharmaceutical analytical documentation must accomplish the key mission of analytics: To monitor and ensure the identity, purity, stability and consistency of drug substances and dosage forms used during preclinical, clinical, and marketing phases in accord with the governing regulatory guidances and policies. Analytical data are the foundation and backbone for pharmaceutical development leading to approval and production of new drugs for market. Analytical documentation provides the critical links during the evolution and

life cycle of a new pharmaceutical product—beginning from earliest studies, enabling entry into humans, through product launch and post-approval changes. Prior to marketing approval, analytical research and development personnel support product development and optimization activities. Following approval, quality control personnel provide the data to assure consistent quality and stability for the marketed product and to support the inevitable changes, which occur in every product's life cycle. Scientifically sound and compliant documents ensure the quality and timeliness of product development and the continued quality of the marketed product.

VIII. CONCLUSIONS

In conclusion, the principles for success in the pharmaceutical industry include

- Collaboration and interaction
- Focus on quality
- Balance of immediate needs and ultimate goals
- Scientifically sound and compliant documentation

These principles are especially critical to the analytical support group, either analytical research and development or quality control.

APPENDIX I: REFERENCES FOR CMC GUIDANCES

The following list contains relevant CMC guidances, draft and final, related to the regulatory and compliance documents required by the FDA for U.S. submissions and by the ICH for international dossiers. Although some of the listed guidances are in draft form, they represent FDA's current thinking and are useful references.

A. IND

- Content and Format of Investigational New Drug Applications (INDs) for Phase 1 Studies of Drugs, Including Well-Characterized, Therapeutic, Biotechnology-Derived Products, November 1995
- INDs for Phase 2 and 3 Studies of Drugs, Including Specified Therapeutic Biotechnology-Derived Products: Chemistry, Manufacturing and Controls Content and Format, February 1999 (Draft)
- IND Meetings for Human Drugs and Biologics Chemistry, Manufacturing and Controls Information, February 2000 (Draft)

B. NDA

- Analytical Procedures and Methods Validation Chemistry, Manufacturing and Controls Documentation, August 2000 (Draft)
- Guideline for the Format and Content of the Chemistry, Manufacturing, and Controls Section of an Application, February 1987

- Guideline for Submitting Supporting Documentation in Drug Applications for the Manufacture of Drug Substances, February 1987
- Guideline for Submitting Supporting Documentation in Drug Applications for the Manufacture of Drug Products, February 1987
- Guideline for Submitting Documentation for the Stability of Human Drugs and Biologics, February 1987
- Guideline for Submitting Samples and Analytical Data for Methods Validation, February 1987
- FDA's Policy Statement for the Development of New Stereoisomeric Drugs, 5/1/92
- Reviewer Guidance Validation of Chromatographic Methods, November 1994
- Guidance for Industry for the Submission of Chemistry, Manufacturing, and Controls Information for Synthetic Peptide Substances, November 1994
- Stability Testing of Drug Substances and Drug Products, June 1998 (Draft)
- Metered Dose Inhaler (MDI) and Dry Powder Inhaler (DPI) Drug Products Chemistry, Manufacturing and Controls Documentation, October 1998 (Draft)
- Nasal Spray and Inhalation Solution, Suspension, and Spray Drug Products, May 1999 (Draft)

C. Postapproval

- Format and Content of the CMC Section of an Annual Report, September 1994
- Immediate Release Solid Oral Dosage Forms—Scale-Up and Post-Approval Changes: Chemistry, Manufacturing, and Controls, In Vitro Dissolution Testing and In Vivo Bioequivalence Documentation, November 1995
- Nonsterile Semisolid Dosage Forms: Scale-Up and Postapproval Changes: Chemistry, Manufacturing, and Controls; In Vitro Release Testing and In Vivo Bioequivalence Documentation, May 1997
- Changes to an Approved Application for Specified Biotechnology and Specified Synthetic Biological Products, July 1997
- SUPAC-MR: Modified Release Solid Oral Dosage Forms Scale-Up and Postapproval Changes: Chemistry, Manufacturing, and Controls; In Vitro Dissolution Testing and In Vivo Bioequivalence Documentation, September 1997
- BACPAC I: Intermediates in Drug Substance Synthesis Bulk Actives Postapproval Changes: Chemistry, Manufacturing, and Controls Documentation, February 2001
- Changes to an Approved NDA or ANDA, November 1999

D. Compliance

- Guideline on General Principles of Process Validation, May 1987
- Manufacturing, Processing, or Holding Active Pharmaceutical Ingredients, March 1998 (Draft)
- Investigating Out of Specifications (OOS) Test Results for Pharmaceutical Production, September 1998 (Draft)

E. ICH

- Q1A: Stability Testing of New Drug Substances and Products, September 1994 (under revision)
- Q1B: Photostability Testing of New Drug Substances and New Drug Products, November 1996
- Q1C: Stability Testing for New Dosage Forms, November 1996
- Q1D: Bracketing and Matrizing Designs for Stability Testing of Drug Substances and Drug Products, November 2000 (Draft)
- Q2A: Text on Validation of Analytical Procedures, March 1995
- Q2B: Validation of Analytical Procedures: Methodology, November 1996
- Q3A: Impurities in New Drug Substances (under revision)
- Q3B: Impurities in New Drug Products (under revision)
- Q3C: Impurities: Residual Solvents
- Q5A: Viral Safety Evaluation of Biotechnology Products Derived from Cell Lines of Human or Animal Origin
- Q5B: Quality of Biotechnological Products: Analysis of the Expression Construct in Cells Used for Production of r-DNA Derived Protein Products, February 1996
- Q5C: Quality of Biotechnological Products: Stability Testing of Biotechnological/Biological Products, July 1996
- Q5D: Derivation and Characterization of Cell Substrates Used for Production of Biotechnological/Biological Products
- Q6A: Specifications: Test Procedures and Acceptance Criteria for New Drug Substances and New Drug Products: Chemical Substances
- Q6B: Specifications: Test Procedures and Acceptance Criteria for Biotechnological/Biological Products
- Q7A: Good Manufacturing Practice Guide for Active Pharmaceutical Ingredients

APPENDIX II: U.S. NDA TABLE OF CONTENTS—ANALYTICAL DOCUMENTATION

CHEMISTRY, MANUFACTURING, AND CONTROLS

A	Drug Substance	
1	Drug Substance Summary	Contributing author to overview
2	Description, Physical and Chemical, Characteristics	
2	1 Nomenclature	
2	2 Structural Formula	
2	3 Physical and Chemical Characteristics	Including: Solubility profile Partition coefficient Dissociation coefficient Optical rotation Thermal properties Crystal morphology Particle size distribution Others, as appropriate
2	4 Solid-State Forms (polymorphs, hydrates, or solvates)	Comparative evaluation of: Analytical methods for determination Physical properties Stability Potential impact on bioavailability Controls (if needed) to assure specified form or ratio of forms
2	5 Reference Standard	Preparation and characterization with respect to identity and purity
2	6 Elucidation of Structure	Analytical proof of structure (and stereochemistry) including: Spectroscopic data Optical rotation X-ray diffraction Thermal analysis Elemental analysis Chemical (purity) data
3	Manufacturer(s)	
4	Method of Manufacture	
5	Container/Closure System	Quality controls for packaging components and materials
6	Process Controls	
6	1 Quality Requirements for Starting Materials	Specifications and methods
6	2 Reagents, Solvents and Auxiliary Materials	Quality controls for identity and purity
6	3 In-Process Controls	Specifications and methods
6	4 Prime Intermediate(s)	Specifications and methods
7	Impurities	Characterization of potential and observed impurities (by- and degradation products)

8		Regulatory Controls for Drug Substance	
8	1	Specifications	Tests, limits and methods used for release and stability testing of finished drug substance
8	2	Rationale for Specifications	Choice of routine tests Development of methods Justification for proposed limits and omitted tests Qualification of specified impurities
8	3	Method Validation	
8	4	Analytical Data	Release results and impurity profiles for: Registration batches Supportive batches (toxicology, clinical and development)
9		Stability	
9	1	Overview of Stability	Summary of primary and supportive data Potential and observed degradation pathway(s) and product(s)
9	2	Batch Descriptions	
9	3	Package Description(s)	Relative to bulk package
9	4	Development Protocols	Storage conditions, time points, tests Stress, accelerated and long-term studies Shipping study
9	5	Analytical Methods	Description of stability indicating methods Comment on differences (if any) versus NDA specifications and methods
9	6	Data	
9	7	Conclusions	Recommended storage condition Proposed retest period Special precautions
9	8	Postapproval Commitment	Sampling plan/frequency Commercial stability protocol

B	Drug Product		
	1	Drug Product Summary	Contributing author to overview
	2	Development Pharmaceutics	Contributing author for development data
	3	Batch Tracking	
	4	Components	
	5	Composition	
	6	Specifications for Inactive Ingredients	Reference for compendial items Additional requirements for compendial items, if any Specifications and methods for noncompendial items
	7	Manufacturer(s)	
	8	Method of Manufacture	
	9	Container/Closure Systems	Bulk and market packages: Quality controls for packaging components and materials Extractables/compatibility data, if needed
	10	Regulatory Controls for Drug Product	
	10	1 Specifications	Tests, limits, and methods used for release and stability testing of drug product
	10	2 Rationale for Specifications	Choice of routine tests Development of methods Justification for proposed limits and omitted tests Qualification of specified impurities
	10	3 Method Validation	
	10	4 Analytical Data	Results, impurity profiles, and dissolution profiles, if applicable, for: Registration batches Supportive batches (clinical and development)
	11	Stability	
	11	1 Overview of Stability	Summary of primary and supportive data Potential and observed degradation pathway(s) and product(s)
	11	2 Batch Descriptions	
	11	3 Package Descriptions	Bulk and proposed market packages
	11	4 Results of Studies	
	11	5 Development Protocols	Stress, accelerated and long-term studies Bulk container Shipping study Reconstitution study, if applicable

	11	6	Analytical Methods	Description of stability indicating methods Comment on differences (if any) versus NDA specifications and methods
	11	7	Data	
	11	8	Statistical Analysis	
	11	9	Conclusions	Recommended storage condition Proposed expiration date Special precautions
	11	10	Post-approval Commitment	Sampling plan/frequency Commercial stability protocol
C			Environmental Assessment	
D			Method Validation	
	1		Exhibit Samples	List of reference standards and exhibit samples of drug substance and product to be provided to FDA laboratory
	2		Certificates of Analysis	For all listed standards and samples
	3		Raw Data	For exhibit samples: Sample chromatograms and spectra Raw data from actual analyses Example calculations
	4		Method Validation Reports	

16

AN INNOVATIVE SEPARATION PLATFORM: ELECTROPHORETIC MICROCHIP TECHNOLOGY

LIAN JI JIN

JEROME FERRANCE

ZHILI HUANG

JAMES P. LANDERS*

*Department of Chemistry, McCormick Road, University of Virginia, Charlottesville,
Virginia 22901*

- I. INTRODUCTION
- II. MICROCHIP FABRICATION
 - A. Microchip Design
 - B. Substrate-Based Fabrication
- III. DETECTION TECHNIQUES
 - A. Laser-Induced Fluorescence
 - B. Mass Spectrometry
 - C. Electrochemical Detection
 - D. Integrated Detection Systems
 - E. Indirect Detection
- IV. PHARMACEUTICAL POTENTIAL
 - A. Chiral Separations
 - B. Small Drug Molecules
 - C. Peptides and Proteins
 - D. DNA-Based Drugs
- V. CONCLUDING REMARKS
- VI. SUMMARY
- REFERENCES

I. INTRODUCTION

Miniaturization in the separation sciences has been prevalent in recent years with the goal being to reduce the consumption of samples, chemicals, and organic solvents, while gaining high speed and high-throughput separation without compromising resolution and detection sensitivity. In the past decade, miniaturization of capillary electrophoresis systems in the form of micro-fabricated electrophoretic devices has achieved great success in comparison with other miniaturized separation techniques. Analyses of a wide variety of molecules have been demonstrated with this new and innovative technology.

*Also with the Department of Pathology, University of Virginia Health Science Center, Charlottesville, Virginia 22901.

It is interesting how the separation sciences have evolved over the past century or so. Michael Tswett¹ must be credited with first exploiting the basic principles of column chromatography for resolving plant pigments on calcium carbonate. Some 40 years later, Martin and Synge² carried out their pioneering experiments with gas-liquid chromatography—this work eventually defined the technique. Two decades after that, high-performance liquid chromatography came on the scene as a result of the ability to produce solid-phase particles that were 10 μm or less in diameter.³ The eventual ability for analysis on reverse-phase systems led to direct application of this separation technology to biological analytes, something that had long been needed. The significance of these developments is simple—the qualitative and/or quantitative detection of molecules, whether from biological specimens or in environmental samples, typically requires some form of separation. Although a variety of analytical techniques have been devised for this purpose, many are either linked directly or indirectly to some form of chromatography or electrophoresis. Typically included are standard liquid chromatography (LC), high-performance liquid chromatography (HPLC), gas chromatography (GC), GC-mass spectrometry (GC-MS), liquid chromatography-mass spectrometry (LC-MS), and one- or two-dimensional electrophoresis.

The brief historical overview of the development of separation science given in the previous paragraph can be augmented to include the development of capillary electrophoresis (CE) as one of the newer techniques to be embraced by the analytical community. This technique, first introduced by Mikkers *et al.*,⁴ and then by Jorgenson and Lukacs⁵ two decades ago, has become known for its versatility in bioanalysis.^{6–11} Many of the salient features associated with CE arise from the design of an instrument that has combined a separation selectivity of standard electrophoresis with the quantitative precision and instrumental control of HPLC. Capillary electrophoresis has several unique advantages over the traditional separation techniques. The most important characteristics of CE are its high efficiency, speed, unprecedented resolution, and small reagent/sample consumption. With CE, the fused silica capillaries are not only used as the separation column, but also as the detection “flow cell,” which distinguishes it from LC. The higher surface-to-volume ratio of capillaries, in comparison with the gel format, allows for dissipation of joule heat in an efficient manner. Consequently, high electric fields (up to 30 kV) can be used, which impacts both separation speed (which is increased) and resolution (which is also increased). With total capillary volumes in the nanoliter to microliter range, only microliter volumes of buffer are used for a given electrophoretic separation, although most commercial instruments have reservoirs that require several milliliters of buffer to avoid buffer depletion problems with consecutive runs. Also a consequence of nanoliter to microliter capillary volumes, injected sample volumes are in the low nanoliter range with most commercial instruments requiring 2–5 μl of sample for efficient sample injection. These microvolume characteristics of CE provide obvious advantages over both slab-gel electrophoresis and HPLC.¹²

The final step in the evolution of electrophoresis to a miniaturized format may be in the form of the budding microchip electrophoresis technology. This microfabricated offspring of CE promises all that CE has delivered (speed,

resolution, and selectivity) but in a format that can allow for massive parallel processing¹³ and, eventually, integrated sample processing.¹⁴

This chapter reviews the current state of the art in the design and fabrication aspects of microfabricated electrophoresis devices, as well as the development of popular detection modes applicable to microchip devices. Potential applications in the pharmaceutical industry are highlighted based on the successful analysis of proteins, peptides, DNA, chiral separations, and some small molecules.

II. MICROCHIP FABRICATION

Microchip electrophoresis is a natural extension of CE, with the capillary replaced by a channel etched into a substrate and then covered with a cover plate to enclose the channel. The components necessary to carry out the electrophoresis including electrodes, buffer reservoirs, and sample reservoirs must be fabricated into the chip itself or designed into an interface that allows the macroscopic world access to the microscopic structures. The design, fabrication, and substrate materials of microchips are the important factors in determining what components can be fabricated into the device itself and what must be included in an interface as well as in determining what types of analyses can be carried out on a given device.

A. Microchip Design

One of the first problems to be addressed in the transfer of electrophoretic methods from capillaries to microchips was the issue of sample injection. In CE, moving the capillary between vials is simple, and pressure injections can easily deliver nanoliter volumes of sample. With microchips, changing the material in the inlet reservoir would require extensive washing before and after it was filled with sample. It is more efficient to design a separate sample reservoir from which injection can take place. In addition, pressure injections cannot accurately deliver picoliter volumes of sample into the separation chamber; thus injections in microchips rely on electrokinetic methods. The initial designs of electrophoretic microchips, therefore, included an injection channel and a channel in which the separation could be carried out.^{15, 16} This design did not allow for good control of how much sample was being injected and was improved upon by the simple cross design.^{17, 18} A long channel is the separation channel, with inlet and outlet reservoirs at the ends; a short cross channel is the sample injection channel, with the sample reservoir at one end and a waste reservoir at the other end. To perform an injection, a potential is applied across the sample and waste reservoirs for a short period of time, allowing the components in the sample reservoir to migrate toward the waste reservoir. The voltages in the inlet and outlet reservoirs are adjusted so that no sample components enter the separation channel. The potential is then switched to across the inlet and outlet reservoirs, and the plug of sample in the injection cross migrates into the separation channel. The volume at the intersection between the two channels determines the amount of injection.

This simple channel design has been modified in a number of ways, depending on the analyses to be carried out. For analytes at low concentrations, two designs have been used to increase the amount of sample in the injection plug. The first uses an offset injection channel where the channel to the waste is slightly below the channel leading from the sample reservoir.¹⁹ In this design, a small portion of the separation channel itself is filled during the injection step. A second method incorporates offset injection with a porous glass membrane to concentrate sample components in the injection plug during the injection step.²⁰ For analytes that are difficult to resolve, additional channel length has been packed into microdevices using serpentine and spiral designs for the channel.²¹ Curves and corners tend to cause broadening of the separating analyte bands and reduce the resolution. For multiple sample analysis, a number of sample reservoirs can be connected to the same separation channel, with separations taking place one after another. An extreme use of this design is seen in the microchips used in the Agilent 2100 BioAnalyzer, a commercial microchip system which contains 13 sample reservoirs, all of which are separated through the same electrophoresis channel.²²

One of the advantages of using microchips is that formation of multiple channels in a substrate is no more difficult than formation of a single channel. Rather than running samples sequentially, these designs restore the parallel processing capability, which was lost in the move from slab-gel to CE instruments. Designs are based on the same principle as the single-channel injection cross, with modifications to allow numerous channels to be fabricated in a limited amount of space. The 96-channel radial design by Mathies and co-workers¹³ is an example of a shared outlet channel. The sample waste reservoirs and inlet reservoirs can also be shared with some creative placement of the channels and reservoirs. Alignment channels have been incorporated into some designs to allow for self-alignment of the detection system with the channels in the microchip.²²

Reservoirs also do not need to be directly in the microchip itself. Chips have been designed in which the interface contains the reservoir and the channels in the microchips extend to the edge.²³ This design has been used not only with single channel designs, but also with multiple channel designs. In a multichannel design, the sample reservoirs have been replaced with a micropositioning injector system.²⁴ Sample plugs, separated by buffer plugs, are sent sequentially into a short capillary tube which is positioned at the entrance to each separation channels. After passage of a sample into that channel, the system moves to the next channel and injects the next sample plug. Continuous operation is achieved by returning the injector to the first channel and injecting a new sample plug once the previous separation has been completed.

Integrated electrodes are another option available for microchips in which the electrodes are fabricated into the microchip itself. Thin strips of metal, usually gold, are deposited on either the substrate containing the channels or the cover plate. Methods for this type of metal deposition and micropatterning are well established in the semiconductor industry. The interface connection then resembles a computer board in which the microchip plugs into a connector to make contact with the power supply. Although useful for disposable

microchips, the high voltages used in electrophoretic separation compromise the long-term stability of these electrodes.

B. Substrate-Based Fabrication

I. Glass and Quartz

The initial choice for preparation of analytical microchip devices was silicon, as it is an ideal substrate for microfabricating.²⁵ It is also a semiconductor, however, making it unsuitable for carrying out electrophoretic separations, and since fluorescence detection is used most often, the devices have to be transparent to visible wavelengths. Silica, glass, and quartz can be microfabricated using the same techniques as silicon, but it is not as amenable for microfabrication of complex structures. Electrophoretic microchips require only simple structures, however, and the excellent electrical properties of silica substrates allow their use in high voltage applications. Glass, therefore, became the substrate of choice for most of the early microchip work. A number of different types of glass have been used in these studies, including borofloat, soda lime, and white crown glasses. Quartz is much more expensive than glass and thus has been used in only a limited number of studies. In particular, quartz microchips are required for applications involving detection using ultraviolet (UV) adsorption, since glass does not transmit UV radiation.^{26–30}

Fabrication of channels in a silica substrate uses a wet etch technique in which a solution of hydrogen fluoride contacts with the silica. To protect the silica from the etch solution, it is first covered with a chrome layer, then with a layer of photoresist. A layer of gold is sometimes placed over the chrome layer to provide increased protection of the silica surface, but this adds additional processing steps. The design to be etched into the surface of the silica is patterned into the photoresist layer using photolithography and a mask containing the design. Film masks made by traditional photographic techniques are inexpensive, but have limited resolution on the order of 20 μm . Metal on glass masks are expensive and take longer to prepare, but have resolution on the order of about 1 μm . Both types of masks are made from computer-generated drawings that contain the structures to be etched.

To transfer the design, the photoresist layer is exposed to UV radiation through the mask. For a positive photoresist, the exposed areas are removed during the development process. This exposes the chrome layer in those areas from which the photoresist was removed. This underlying chrome layer is then etched away to expose the silica surface. Etching of the exposed silica is carried out using a hydrofluoric acid solution. The depth of etching is controlled by the time the solution contacts with the silica. After this wet etching, the remaining photoresist is stripped away and the rest of the chrome layer is removed. The silica is then cleaned and bonded to a cover plate through which reservoirs have been formed if necessary. Figure 1 shows scanning electron micrographs of microchannels created in the surface of borofloat glass.

Bonding is carried out in one of three ways. Anodic bonding uses a potential difference between the two plates to melt and seal the interface. Thermal bonding accomplishes the same seal using heat and pressure to join the two

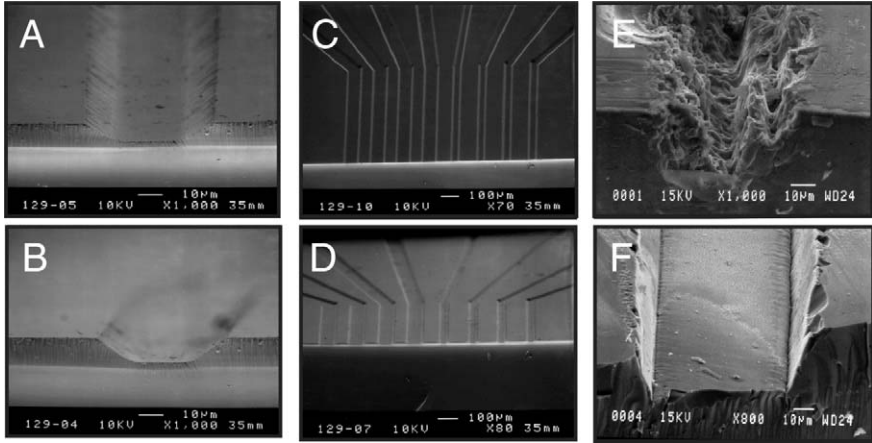

FIGURE I Scanning electron micrographs of microchannels created in the surface of borofloat glass: single channels created via wet etching (viewed from different angles) (A and B); multiple channels created via wet etching (viewed from different angles) (C and D); channels created through laser ablation with either a YAG laser (E) or an eximer laser (F).

silica surfaces. With thermal bonding, the softening point temperature of the substrate must not be exceeded, and the two plates being bonded must have the same thermal expansion coefficient. UV bonding employs a UV active adhesive which is spread between the two plates and then exposed to UV radiation to cure the adhesive. Different glasses can be sealed together using this method.

2. Polymers

A number of different polymers have been used in the production of microchip electrophoretic devices. One class of polymers is thermoplastics, which melt above a certain temperature but are hard at room temperature. Materials from this class that have been used in the formation of microchip devices include polymethylmethacrylate, polycarbonate, polyethylene, polystyrene, and a number of others. An excellent review on the fabrication and use of polymeric materials in microchips was presented by Becker and Gartner.³¹ The second class of materials is elastomeric polymers, the most widely used of which is poly(dimethylsiloxane) (PDMS). Use of this material was covered in a review by McDonald *et al.*³²

For thermoplastics, the driving force is the low cost of mass producing such devices. This low price is realized only where replication techniques, such as hot embossing or injection molding, can be used for preparation of the microchips. These techniques require production of a master mold, with an initial expense, but it can be used repeatedly. For testing of initial designs, the microchips must be individually crafted, which is expensive and time consuming. The preferred method, where possible, is to use laser ablation to “etch” the surface of the polymer to form the necessary structures. This method typically requires a pulsed eximer laser to blast away the surface of the plastic. Lithographic techniques have also been used with photoreactive polymers, forming structures with masks similar to those used for glass fabrication methods.

A second layer of substrate must be bonded on the patterned surface to complete the fabrication. This must be done without affecting the pattern or clogging the channels that have been formed. Both adhesive and thermal methods can be used to achieve this bonding.

Fabrication of the PDMS devices is much simpler because this polymer can be cast and hardened in a mold with only moderate heating to promote polymerization. Master molds for generating these chips are made lithographically using a photoreactive epoxy. The epoxy is coated onto a glass or silicon substrate then exposed to UV radiation through a mask, leaving the features to be patterned into the PDMS above the surface of the substrate. PDMS is cast over the surface of the master and then gently pulled off once polymerization is complete. The design on the master is faithfully reproduced in the PDMS surface, and hundreds of replicates can be formed from the same master.

To complete these devices, the patterned PDMS is sealed against a second layer. PDMS has successfully been bonded to itself by oxidizing the surfaces of the two layers in an oxygen plasma before pressing them together. Reversibly binding the PDMS layer to a glass substrate has proven to be more useful for a number of applications, however. The PDMS and glass surfaces are cleaned with isopropanol and then pressed together to remove any air pockets between them. Clogged channels are easily fixed by peeling away the PDMS and washing the channel clean. The PDMS layer can then be resealed to the glass to reform a working device. The flexibility of the PDMS allows it to be sealed against surfaces that are not perfectly flat, providing additional areas in which it proves useful. A recent example is a device incorporating electrochemical detection, in which the working electrodes are formed directly on a glass plate. The channel in the PDMS is positioned directly over the electrodes and when pressed down seals the PDMS layer around the electrodes.³³ Because these electrodes are fouled during continued use, the original design included a number of working electrodes, with the PDMS layer being peeled off and repositioned over new electrodes as needed.

III. DETECTION TECHNIQUES

Many of the detection modes that have been successfully used in GC, LC, and CE techniques have been interfaced with microchips. These include UV, fluorescence, mass spectrometric, and electrochemical detection, all of which have allowed initial demonstrations of the effectiveness of microfabricated devices for electrophoretic separations of a variety of analytes. While some of the macrodetection techniques will be difficult to miniaturize (e.g., mass spectrometry), there is much to be gained through the interfacing of the ultrafast, high-throughput capabilities inherent in the microchip with these detection methods. Ultimately, microminiatured detection approaches that can be integrated into the chip will be needed. In this section, we will present an overview of current development in the area of interfacing macrodetection techniques with the microchip world.

A. Laser-Induced Fluorescence

Fluorescence is a detection method with exquisite sensitivity and selectivity that is applicable to a wide variety of biomolecular components.^{34–36} Fluorescence is a three-stage process that occurs in certain molecules, fluorophores, or fluorescent dyes when excited with the appropriate energy (i.e., wavelength of light). In stage 1, excitation is induced by a photon of energy, $h\nu_{\text{EX}}$ provided by an external light source, such as an incandescent lamp, a UV light, or a laser, and absorbed by the fluorophore—this creates an excited electronic singlet state (S'_1). The excited state exists for a finite time (typically $1\text{--}10 \times 10^{-9}$ s). During this time, the energy of S'_1 is partially dissipated, yielding a relaxed singlet excited state (S_1) from which fluorescence emits. In stage 3, fluorescence emission occurs as a photon of energy $h\nu_{\text{EM}}$ is emitted, returning the fluorophore to its initial state S_0 . Because of energy dissipation during the excited-state lifetime, the energy associated with this photon is lower and, therefore, of longer wavelength than the excitation photon $h\nu_{\text{EX}}$. The difference in energy represented by $(h\nu_{\text{EX}} - h\nu_{\text{EM}})$ is called the Stokes shift and is fundamental to the sensitivity of fluorescence detection.

There are four essential components of fluorescence detection: (1) the excitation source, (2) the fluorophore, (3) the wavelength filter, which isolates the emission wavelength(s) from the excitation wavelength, and (4) the detector that translates the detected emission photons to a recordable output (e.g., an electrical signal or a photographic image). According to the information provided, fluorescence detectors can be cataloged primarily in three categories:

1. Spectrofluorometers and microplate readers, which are extremely flexible, providing continuous ranges of excitation and emission wavelengths and measuring the average properties of samples in the microliter to milliliter range.
2. Fluorescence scanners and fluorescence microscopes, which detect fluorescence as a function of spatial coordinates in two or three dimensions for microscopic objects.
3. Flow cytometers, which measure the fluorescence emitted per cell in a flowing stream, allowing for subpopulations within a large sample to be identified and quantified.

The emission intensity of fluorescence depends on the product of the molar extinction coefficient, the optical path length, the solute concentration, the fluorescence quantum yield of the dye, and the excitation source intensity. In dilute solutions, the intensity is linearly proportional to these parameters. When sample absorbance exceeds about 0.05 in a 1-cm path length, the relationship becomes nonlinear and measurements may be distorted by artifacts such as self-absorption and the inner-filter effect.

With respect to detection for CE, laser-induced fluorescence (LIF) detection is an attractive approach as a result of the sensitivity attainable despite the short path length. For this reason, it is well suited to microchip electrophoretic analysis of a variety of analytes including DNA fragment sizing and sequencing.³⁷ The excitation source is usually a continuous-wave argon ion laser, which is focused in a capillary or on a microchannel in a microchip.

The samples, which must be either fluorescent naturally or labeled with fluorescent probes, are efficiently excited by the laser, and the emission corresponds with the concentration of the samples. An objective focusing on the capillary or microchannel plane allows for efficient collection of the emission signals. A detector, usually a photomultiplier tube (PMT) or a charge-coupled device (CCD) camera, is used to convert the photon signals to electric signals for amplification, noise cancellation, and processing. The LIF detection for this application has significant advantages over all other technologies. First, the fluorescent signals are linear over a wide concentration range, allowing for quantification via multicolor analysis. Second, careful selection of the fluorescent probes allows for good spatial resolution where multiple variables can be measured simultaneously. Finally, if the fluorescence-labeled probes are relatively photostable, sample preparation is easier and detection reproducibility can be excellent.

As a means of increasing sample throughput with either the capillary or microchip platforms, single-capillary or microchannel systems have been extrapolated to capillary arrays or multimicrochannel systems. The multiplexing of electrophoresis in multiple capillaries or multiple channels on a chip is not only complex from a sample injection and separation perspective, but also complicated by the fact that rapid and effective fluorescence detection from an array of capillaries or channels must be achieved. Several reports in the literature have described the use of CCD cameras for low-intensity-level LIF detection in CE as well as various laser beam-scanning approaches. Mathies and co-workers³⁸ in 1992 described effective fluorescence detection in multiple-channel chip devices by translating the microchip over a stationary laser beam. Mathies and co-workers³⁹ also developed a “spinning objective” system, which allows LIF detection on 96 channels in a silica microplate. Landers and co-workers⁴⁰ demonstrated an acoustooptic deflection (AOD)-based system for high-speed laser scanning applied to fluorescence detection of multiple channels on a microfabricated chip and illustrated this technology for simultaneous fluorescence detection from multiple channels on a microchip. The schematic diagram of an AOD laser scanning system for LIF detection is shown in Figure 2.

A multicolor detection system uses two or more fluorophores to simultaneously monitor different analytes. If the fluorophores do not have high molar absorbance at a single excitation wavelength, two or more wavelengths from the excitation laser may be required. Moreover, detection requires two or more PMTs to obtain the photon signals specific to each fluorophore. Although complicated, the development of such an optical system has been demonstrated for large-scale DNA sequencing.⁴¹ This method uses four fluorophores, one for each base, and sequencing fragments are detected based on each color. Other major applications of this technique include flow cytometry, fluorescence *in situ* hybridization, and fluorescence microscopy.

It is important to note that several factors may limit fluorescence detectability. Background signals originating from endogenous sample or from unbound or nonspecifically bound probes may affect detection sensitivity severely. By narrowing the bandwidth of the fluorescence detection, the background signals may be blocked, but the overall detection of the fluorescence

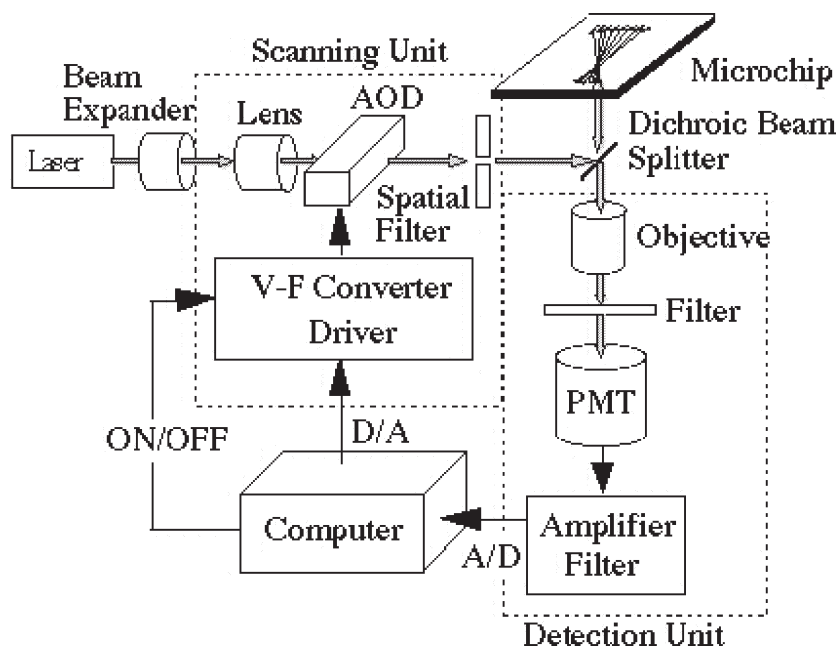

FIGURE 2 An AOD-driven laser-induced fluorescence scanning system configuration. A continuous wave argon ion laser is used. To optimize focusing, the laser beam is expanded before presentation to the focusing lens. This setup allows the beam to be focused within the microchip channel with a final diameter of less than $50\ \mu\text{m}$. The AOD is placed after the lens to deflect the laser beam. A spatial filter after the AOD is used to select the first-order diffraction beam and obstruct the zero-, second- and higher-order diffraction to reduce extraneous scattered light on the microchip. The accuracy of the laser spot position on the microchip is governed by a voltage that is output from a computer. This output voltage is converted by a digital-to-analog (D/A) converter, and then sent to the AOD driver where the voltage-frequency (V-F) converter outputs the desired radiofrequency signal to the AOD. Fluorescence emitted from the excited sample is collected by an objective, passed through a dichroic beam splitter, and filtered spectrally before being received by the PMT. The PMT information is amplified and filtered electronically to reduce environmental noise for signal optimization. Reprinted with permission from [40]. Copyright 1999, The American Chemical Society.

intensity may be compromised as well. Photobleaching, an irreversible destruction of the excited fluorophore under high-intensity illumination, may also occur. The most effective remedy for photobleaching is attainable through a balance between the maximum fluorescence signal and a lower excitation source intensity. Low-light detection devices such as an intensified CCD camera or a highly sensitive PMT can enhance detection sensitivity.

B. Mass Spectrometry

MS is the most powerful high-speed and high-throughput detection technique developed so far for the analysis of samples of complex biological origins. Following the success of MS coupling to CE systems, the interest in coupling MS to microfabricated devices has escalated. Electrospray ionization remains the most popular mode for coupling MS detection to microfabricated devices, as is the case for HPLC and CE. A few dedicated research groups have success-

fully demonstrated the interfacing of microfabricated capillary electrophoretic devices with mass spectrometry.^{42–58}

Karger and co-workers⁴² interfaced microfabricated multiple-channel glass chips to an electrospray ionization (ESI) mass spectrometer. A high voltage was applied to each channel for spraying sample sequentially to the mass spectrometer sampling orifice, which was grounded. With no separation before spraying, myoglobin was successfully analyzed with good sensitivity. This same group⁴³ studied two approaches for coupling microfabricated devices to an ESI ion trap mass spectrometer. With both approaches, sample inlet ports, preconcentration sample loops, the separation channel, and a port for ESI coupling were fabricated on a single device. The first approach coupled a modular, reusable microdevice to an external subatmospheric electrospray interface via a liquid junction and a fused silica transfer capillary. The transfer capillary functioned as an independent electrospray interface as well as a fiberoptic UV detector. CE separation of cytochrome *c* tryptic digest on a microdevice was demonstrated with the transfer line and subatmospheric ESI interface. The second approach fabricated a pneumatic nebulizer as an integral part of the chip. The on-chip pneumatic nebulizer controlled the electrosprayed liquid flow and minimized the dead volume associated with the droplet formation at the electrospray exit port. CE separation of angiotensin peptides was tested with this device. In a following work,⁴⁴ they further improved their first approach⁴³ by fabricating a guiding channel into the device for the insertion of the electrospray capillary. CE/MS of peptides, proteins, and protein tryptic digests was demonstrated using on-line tandem MS for the structure identification of the protein digest products.

Ramsey and Ramsey⁴⁵ also described microchip interfacing to an ion trap mass spectrometer. Microfluidic delivery was realized by electroosmotically induced pressures and electrostatic spray at the channel terminus was achieved by applying a potential between the microchip and a conductor spaced 3–5 mm from the channel terminus. Tetrabutylammonium iodide was tested as a model compound with this device. Later, Ramsey *et al.*⁴⁶ reported use of a microchip nanoelectrospray tip coupled to a time-of-flight mass spectrometer for subattomole sensitivity detection of peptides and proteins. A fluid delivery rate of 20–30 nL/min was readily obtained by applying an electrospray voltage to the microchip and the nanospray capillary attached at the end of the microfabricated channel without any pressure assistance.

Aebersold and co-workers⁴⁷ constructed a device with etched sample and buffer reservoirs connected via etched channels and a capillary “pump” to a microelectrospray ion source. Peptide samples and unseparated tryptic digests of proteins are applied to different reservoirs. Electroosmotic pumping selectively directed the sample from a specific reservoir to the microsyringe and mass spectrometer. No cross-contamination occurred by sequential mobilization of samples deposited in different reservoirs. The spectra of fibrinopeptide A and a tryptic digest of carbonic anhydrase were obtained by a tandem mass spectrometer. In a subsequent paper, Aebersold and Figeys⁴⁸ described the construction of a microfabricated device for the generation and delivery of solvent gradients at nanoliter per minute flow rates by electroosmotic pumping. Three solvent reservoirs and channels were etched in glass so that solvent gradients

and flows could be generated by differential electroosmotic pumping of the aqueous and organic solution, all controlled by computer. The device was interfaced to an electroosmotic pump, a reverse-phase microcolumn and an ESI ion trap mass spectrometer. A sample was pressure loaded onto the solid-phase extraction device in the liquid junction interface. Analyses of a myoglobin tryptic digest, a band of yeast protein separated by one-dimensional gel electrophoresis of yeast total cell lysate digested with trypsin, and a spot of yeast protein separated by two-dimensional (2D) gel electrophoresis of yeast total cell lysate digested with trypsin were demonstrated with this system at the low femtomole level. In follow-up studies,⁴⁹ the analysis system described in reference 48 was modified to improve the throughput by increasing the number of reservoirs with samples and applying high-voltage relays to generate electroosmotic pumping. Sequential automated analysis of protein digests obtained by 2D gel electrophoresis was demonstrated by tandem MS. The spectra from sequential analysis of model samples, which included 182 fmol/ μ L bovine serum albumin tryptic digests (reservoir 1), 237 fmol/ μ L myoglobin tryptic digests (reservoir 2), followed by 222 fmol/ μ L haptoglobin tryptic digests (reservoir 3), were presented. In a recent paper, Figeys and co-workers⁵⁰ introduced new approaches that improved the robustness, user friendliness, and performance of the microfabricated fluidic system (μ FAB). The development of a convenient mount to connect a μ FAB device to the ESI mass spectrometer and the incorporation of filters in the reservoirs and exit of the μ FAB were shown. Improvement in sample handling and delivery by using nonaqueous electrolyte or cationic coating on the surfaces in the μ FAB device was also obtained. A protein Qstar mass spectrum from a tryptic digest of β -casein at 660 fmol/ μ L was shown.

Little *et al.*⁵¹ fabricated on a <1 in.² silicon chip 100 individual etched wells for array analysis of synthetic oligonucleotides and DNA diagnostic products by matrix-assisted laser desorption/ionization time-of-flight (MALDI-TOF) MS. Low-nanoliter aliquots of matrix and DNA are dispensed by a piezoelectric pipet into wells. Point mutations in apolipoprotein B alleles, which are associated with abnormal cholesterol transport and metabolism, were detected by dispensing 5 nL of polymerase chain reaction (PCR) product into the wells and analyzing with MALDI-TOF MS. The presence of a second peak in the mutant allele relative to the wild-type allele was indicative of a heterozygous mutation at codon 3500. Microsatellite genotyping of an AAAT repeat region in an AluVpA microsatellite within intron 5 of the interferon- α receptor gene was also demonstrated. Not only was it possible to identify the possible repeat units of 8–13 AAAT by PROBE (primer oligo base extension) in a manner comparable to electrophoresis, but also a second site mutation (T \rightarrow G) within the eighth repeat was discovered and verified by direct sequencing.

Smith and co-workers⁵² designed a microfabricated dialysis device for sample cleanup before ESI MS. A microdialysis membrane sandwiched between two chips having micromachined serpentine channels provided efficient desalting for both DNA and protein samples before subsequent ESI ion trap MS. In a continuation study, they used a fabricated dual microdialysis membrane for removing both high- and low-molecular-weight species that

interfere with ESI MS of target biopolymers.⁵³ More recently,⁵⁴ they microfabricated an isoelectric focusing (IEF) device for direct ESI MS. The IEF device was constructed on polycarbonate plates using laser micromachining, incorporating a sharp emitter ESI tip and sheath gas and sheath liquid fluid connectors. Microchannel IEF separation of a protein mixture of carbonic anhydrase (pI 5.9) and myoglobin (pI 7.2), followed subsequently by ESI MS, was demonstrated.

Thibault and co-workers⁵⁵ described a micromachined chip device coupling for ESI MS. On-chip separation was achieved with rapid sample cleanup and resolution of multicomponent samples before MS analysis. Two interfaces were evaluated, which involved a disposable nanoelectrospray emitter and a more conventional sheath flow ES/MS interface for the separation and identification of peptide mixtures and tryptic peptides. They further demonstrated the applicability of the microfabricated device with short disposable nanoelectrospray emitters described in reference 55 (Fig. 3A) for the separation and identification of peptides from gel-isolated membrane proteins, using both a triple quadrupole and a quadrupole TOF mass spectrometer (Fig. 3B).⁵⁶ A concentration detection limit of 3.2–43.5 nM for different peptides was obtained in selected ion monitoring, representing a 10-fold improvement in sensitivity compared to that of sheath flow microelectrospray using the same chip/MS. Although complete resolution of individual components from complex digests was not achieved, the chip device provided adequate sample cleanup and partial separation before MS identification. The potential of the device for the identification of trace-level proteins from different strains of

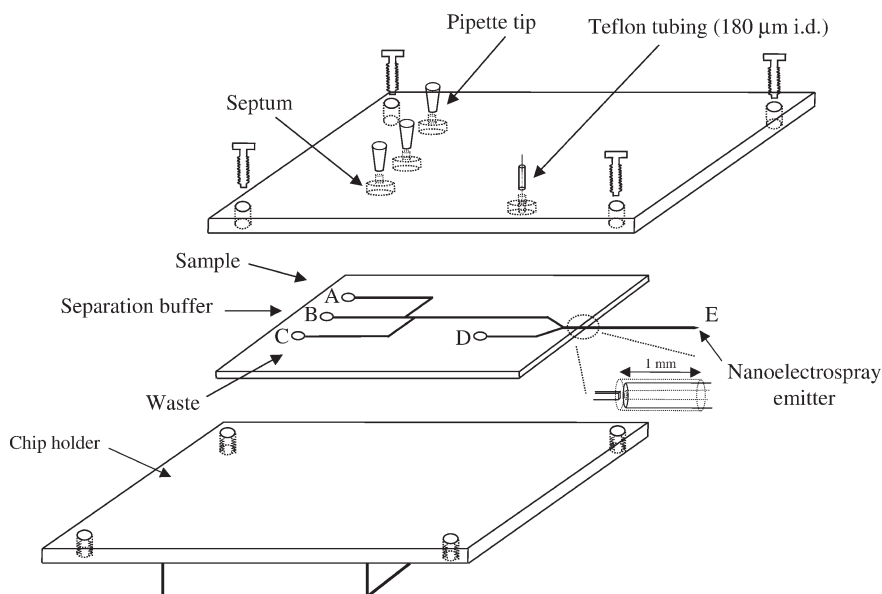

FIGURE 3A Schematic representation of the chip-CE configuration using a disposable nanoelectrospray emitter interfaced to either a triple quadrupole or a hybrid quadrupole TOF mass spectrometer. Reprinted with permission from [56]. Copyright 2000, The American Chemical Society.

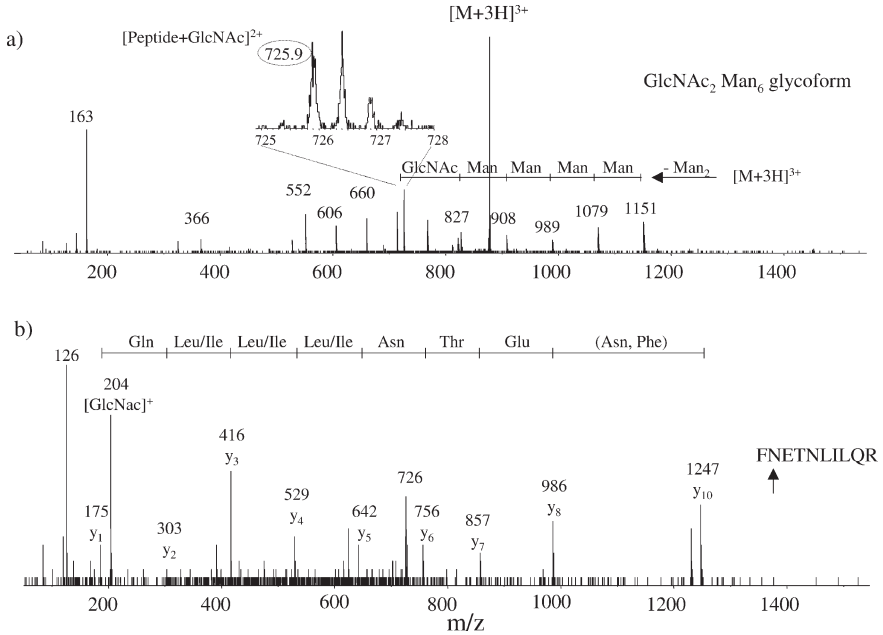

FIGURE 3B Chip-CE-MS-MS analysis of tryptic peptides from *Phaseolus vulgaris* leucoagglutinin: (a) product ion of m/z 876.1 and (b) second generation of fragment ion for precursor at m/z 726. Separation conditions: electrolyte, 0.1M formic acid; -2.5 kV injection potential; $+2$ kV was applied at the emitter. Ar is used as a target gas at collision energy E_{lab} (laboratory frame of reference) of 60 eV (orifice voltage 60 V) for (a) and 70 eV (orifice voltage 150 V) for (b). Reprinted with permission from [56]. Copyright 2000, The American Chemical Society.

Haemophilus influenzae was further demonstrated using both peptide mass-fingerprint database searching and an on-line tandem mass spectrometer. This same group recently incorporated two different on-chip sample preconcentrators to the same microfabricated device with nanoelectrospray emitters evaluated in references 55 and 56 for the purpose of enhancing sample loading for protein analyses.⁵⁷ A sample stacking procedure was integrated onto the microfabricated device by polarity switching to remove the sample buffer before zone electrophoresis. A 70-nL sample injection was achieved with sub-nanomolar detection limits for most peptide standards. For larger sample loading, a disposable adsorption preconcentrator using a C_{18} membrane is incorporated outside the chip, providing several microliters of sample with detection limits of 2.5 nM for hydrophobic peptides. Both sample enrichment approaches were evaluated for the identification of bands isolated from 2D gel separation of protein extracts from *H. influenzae*. Accurate molecular mass <5 ppm in peptide mapping is obtained by the introduction of internal standard via a postseparation channel.

Lee and co-workers⁵⁸ demonstrated that a micromachined parylene nozzle could serve as an electrospray emitter on a silicon chip. This hollow-needle structure extended more than a millimeter beyond the edge of the silicon substrate. MS/MS analysis of the mixture of peptides obtained from the trypsin digest of cytochrome *c* was demonstrated with this micromachined emitter, and

results compared favorably with those from a pulled borosilicate nanospray emitter.

In summary, microfabricated device coupling to existing mass spectrometers has clearly progressed rapidly in the last few years. The initial interface was mainly the delivery of fluids by electroosmotic pumping in a microchannel with coupling to the mass spectrometer by a capillary emitter. However, later developers have begun to integrate sample pretreatment and separation before ESI. It appears that integrated micromachined emitters can be created and used effectively in lieu of the capillary emitters that set the standard. New developments and approaches will continuously appear to accomplish the interfacing of high-speed and high-throughput separation on microfabricated devices with high-speed and high-throughput MS detection for efficient, sensitive analysis of target molecules.

C. Electrochemical Detection

CE with electrochemical detection (ED) has been explored as an alternative detection technique for pharmaceutical and biomedical applications.⁵⁹ Although CE-ED has not been routinely applied in pharmaceutical and biomedical laboratories, its selectivity, sensitivity, and ability to detect low-level biomolecules without prior derivatization make it an attractive alternative detection technique. Recently, microfabricated devices integrated with ED have been described.^{60, 61} Woolley and co-workers⁶⁰ microfabricated a device on a glass substrate with an integrated Pt working electrode in the exit channel just beyond the end of the separation channel. Electrophoretic analysis of neurotransmitters, Φ X174 *Hae*III restriction digest (1 ng/ μ L), and a *Salmonella* PCR product was demonstrated on this device. Rossier and co-workers⁶¹ presented integrated ED in polymer microchannels fabricated by UV laser photoablation. Carbon microband electrodes were placed either in the bottom or in the side wall of the rectangular microchannel. Detection limits of $\sim 3 \mu$ M were obtained for chronoamperometry. Although the research into microfabricated devices integrated with ED is still at an early stage, interest in this area remains. The potential of this technique, as a result of its capabilities for integrating electrodes and electrochemical detection into a single microfabricated device, may be more promising than that of other detection approaches.

D. Integrated Detection Systems

The fluorescence detection system used in the current microchip designs consists of an incoming laser to excite the fluorescence and the collection/detection hardware to measure the emission wavelength. This system has been integrated to some extent by replacing the optics with fiberoptic cables. These fiberoptic cables bring the excitation wavelength directly to the channel and then collect the emission wavelength and transport it to the PMT.⁶² In one system, the fiberoptic cable was coupled directly to a waveguide fabricated into the microdevice itself.⁶³ This system has been used to measure absorbance, but it has not yet been adapted for LIF detection.

To develop a truly integrated LIF detection system, both halves of the system must be miniaturized, then built within the chip itself. Photodiode lasers, micro-diode array detectors, and miniature PMTs represent the miniaturized components needed, and these components are in use in the commercial microchip instrument. Direct integration of the laser into the chip is being explored by a group from Sandia National Laboratory.⁶⁴ The excitation system consists of a vertical cavity surface-emitting laser with two microlenses to focus the light onto the channel. The laser and lenses are microfabricated directly into the silicon substrate containing the channel using electron beam lithography and reactive ion etching. They have further modified their system to include the semiconductor laser, the optics, and a photodiode detector, all within a volume less than 1 cm³.⁶⁵

The most significant problem with integration, thus far, is the inability to miniaturize the source of the 488 nm line (argon ion laser) that is so useful in LIF. Most fluorescent dyes of practical interest are excited by this wavelength, but wavelengths in this region have not been achieved in miniature devices thus far. The dyes used in the commercial microchip instrument and in the integrated laser⁶⁴ rely on excitation wavelengths in the red part of the spectrum. Although these dyes have proven to be functional, there is a limited selection available.

E. Indirect Detection

One problem with LIF detection is its requirement that the analytes of interest fluoresce. Unfortunately, few compounds of interest are naturally fluorescent and, therefore, must be labeled. Labeling can be either covalent, in which case the analytes must be derivatized before or after the separation step, or associative, as with DNA intercalating dyes. One alternative, which has been shown to be successful with microdevices, is indirect fluorescence. With this approach, the background solution (separation medium) contains a charged fluorescent species. As the charged analytes form electrophoretic (nonfluorescent) zones, the detector identifies the zones by the reduced fluorescence as the analytes displace the background fluorophore. Because there is no labeling of the analytes, this is an easy method to implement and is readily applicable to many interesting charged species.

Munro *et al.*⁶⁶ have used this method to detect amino acids in urine samples. Having defined the separation conditions and background fluorophore (fluorescein) using a capillary instrument, transfer to a microchip was possible where 15 of the 20 normal amino acids in a standard mixture could be distinguished (Fig. 4). With attomole detection possible (low micromolar), this method is substantially less sensitive than standard LIF, but is valuable because no sample preparation is needed. At the detection limit, patients with altered levels of amino acids in their urine relative to normal patients were identified. Wallenborg and Bailey⁶⁷ used this same approach to detect explosive compounds via microchip separation. Standard samples containing 14 explosive compounds showed good detection limits for nitroaromatic compounds. The presence of 1 ppm of these nitroaromatic compounds in soil samples could be detected using this method.

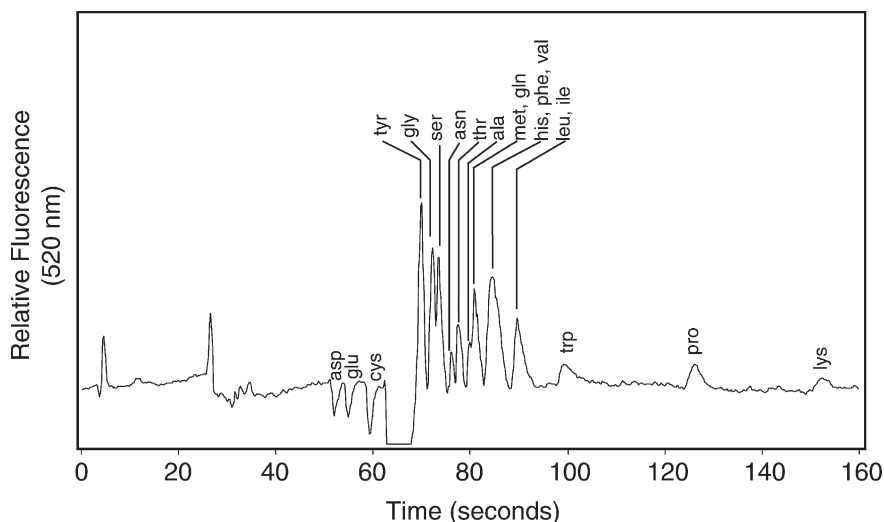

FIGURE 4 Indirect laser-induced fluorescence detection of 19 amino acids by microchip electrophoresis. Separation buffer: 1.0 mM sodium carbonate, 0.5 mM fluorescein, and 0.2 mM CTAOH at pH 10.3. Separation condition: l_{eff} 5.5 cm, 15 s injection at 417 V/cm (reversed polarity), 183 V/cm separation voltage, sample amino acid concentrations of 0.4 mM in 1.0 mM sodium carbonate and 0.2 mM CTAOH. Reprinted with permission from [66]. Copyright 2000, The American Chemical Society.

IV. PHARMACEUTICAL POTENTIAL

Use of capillary electrophoresis has been a great success in pharmaceutical analysis. Its further extension to microfabricated electrophoresis devices is anticipated to gain momentum in the not too distant future.

A. Chiral Separations

The success of chiral separation achieved by capillary electrophoresis has been extended to microfabricated electrophoretic devices.^{68–70} Because the chiral separation mechanism exploited is the same, the common electrophoretic buffer systems and chiral discrimination agents (e.g., cyclodextrins) used in CE can be readily transferred to the microchip platform. As fluorescence detection is currently the dominant detection technique on microchips, analytes without a fluorophore need to be labeled with a fluorescence tag to be detected—this is a limiting factor for widespread application in pharmaceutical chiral analysis. However, this situation will be greatly changed when a UV detection system with sufficient sensitivity that is applicable to microchip devices is available. Mathies and co-workers⁶⁸ were the first to describe an amino acid analyzer microfabricated on a glass substrate with a long folded channel, with the goal being to detect extinct or extant life in extraterrestrial samples via amino acid analysis. Amino acids labeled by fluorescein isothiocyanate (FITC) were separated with a sodium dodecyl sulfate/carbonate buffer at pH 10 with γ -cyclodextrin as the chiral discriminator. Li and co-workers⁶⁹ demonstrated high-speed chiral separations on microchip electrophoresis devices.

FITC-labeled amino acids as model compounds were separated in sodium dodecyl sulfate/borate buffer at pH 9.4 with γ -cyclodextrin as chiral discriminator. Separation speed achieved with the microchip was one order of magnitude faster than that with conventional CE. Bailey and co-workers⁷⁰ demonstrated chiral and achiral separation of amphetamine and analogous compounds labeled with 4-fluoro-7-nitrobenzofurazane on an S-folded separation channel. Phosphate buffer with sulfated γ -cyclodextrin and sodium dodecyl sulfate as additives was used. It is expected that chiral separations on microfabricated electrophoresis devices with high speed and high throughput will find its way into pharmaceutical and biomedical sciences as well as into other areas.

B. Small Drug Molecules

Small drug molecules have not been extensively researched with microchip electrophoresis devices despite the great potential achieved in conventional CE systems. One reason is that most of the small drug molecules possess chromophores; thus, UV absorbance detection is the most popular detection mode but it is not universally available for a microchip device such as LIF is because of sensitivity problems. Because of the radiation danger imposed by UV light, proper instrumental setup specific to the microchip format is required. In addition, UV transparent material such as fused silica or fused quartz is required to fabricate the microchip device. Because UV absorbance is much less sensitive than LIF, a special design is necessary to increase the optical path length of the detection flow cell. This has been achieved by some clever approaches pioneered by Harrison and co-workers.⁷¹ Recently, a commercial microchip electrophoresis system with UV detection was released by Shimadzu, which will drive the application of microanalytical techniques to a wide variety of molecules of pharmaceutical interest.

C. Peptides and Proteins

The identification and characterization of peptides and proteins from biological sources are important for understanding disease states and searching for drug targets. The current method of choice for protein analysis from biological sources is the combination of 2D gel electrophoresis and MS. Large quantities of proteins have been identified and characterized with this powerful combination. Even so, this combination is not without limitations. The inherent problem with 2D gel electrophoresis is that the separation in the two dimensions is executed independently. After the first-dimension separation is carried out, the gel strips need to be manually transferred to the second dimension to perform second-dimension electrophoresis. To present an overview of current developments in this technique, four issues of *Electrophoresis* are devoted to the state of the art in proteomics and pharmaceutical proteomics.^{72–75} In parallel, microfabricated devices have been coupled to mass spectrometry in a few research laboratories for protein and peptide analysis. Those results were summarized in Section III.B of this chapter. Although these results are preliminary, microchip devices already show promise as on-line integral sample

purification and separation devices to reduce sample complexity before MS and toward automation.

D. DNA-Based Drugs

As the Human Genome Program enters its final stage, all of the human genes have been sequenced and several disease-causing genes have been identified. The research to use DNA as a drug and/or drug target is very active and of tremendous interest. One type of DNA-based drug, short synthetic DNA molecules 7 to 30 nucleotides in length and complementary to a transcript of a known sequence, is designed to bind to target mRNA and interfere with the ability of the mRNA to be translated into protein. This short synthetic oligonucleotide is termed antisense DNA because its sequence is complementary to mRNA that contains "sense."⁷⁶ Other DNA-based drugs include DNA vaccines, triplex-forming oligonucleotides, protein-binding oligonucleotides, and ribozymes.⁷⁷

Microfabricated electrophoresis devices for nucleic acid analysis are a subject of intense interest induced by the great success of CE in DNA sequencing, mutation detection, and PCR-based DNA analysis. Results show that microfabricated electrophoresis devices are equally valuable for such purposes and even surpass CE in separation speed and throughput. High speed and high throughput are proven characteristics of microfabricated electrophoresis devices. Single and/or multichannel devices along with single and/or multicolor fluorescence detection systems were used for the investigations. The achievements described in the following text will give a glimpse of the power and beauty of microfabricated electrophoresis devices. Electrophoretic microchips have been used to size short oligonucleotides 10–25 bases long,⁷⁸ restriction fragments such as Φ X174 *Hae*III digested DNA,^{79–83} and ribosomal RNA.⁸⁴ A capillary array electrophoresis microchip containing 12 channels was used for parallel analysis of restriction fragment markers from the *HLA-H* gene, a candidate gene for diagnosis of hereditary hemochromatosis.²² A microchip with 48 channels and 96 sample wells was developed to analyze 96 hemochromatosis samples in less than 8 min.⁸⁵ Recently, a 96-channel radial capillary array electrophoresis microplate was developed for parallel genotyping of alleles of methylenetetrahydrofolate (MTHFR) reductase, a gene that encodes a protein critical in the regulation of folate and methionine metabolism.¹³ A glass microchip was used to perform single-strand conformation polymorphism analysis. Tian *et al.*⁸⁶ could detect three common mutations in two breast cancer susceptibility genes, *BRCA1* and *BRCA2*, identified in the Ashkenazi Jewish population. For detection of nonhuman DNA, the detection of herpes simplex virus (HSV) PCR products from cerebrospinal fluid (CSF) for the rapid diagnosis of herpes simplex encephalitis (HSE) was accomplished on a coated glass microchip.⁸⁷ Figure 5 shows separations of HSV PCR-positive and PCR-negative CSF specimens by microchip electrophoresis. A single-channel plastic microchip has also been used for electrophoretic detection of PCR products of the hepatitis C virus.⁸⁸ The detection of T- and B-cell lymphoproliferative disorders was also demonstrated on a microchip device.⁸⁹ Microchip-based electrophoretic separation effectively resolved PCR-amplified

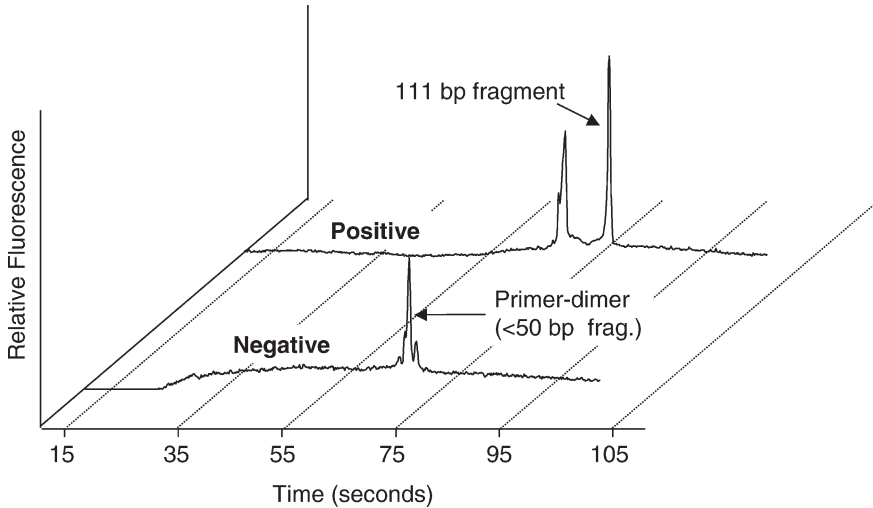

FIGURE 5 Separation of HSV PCR-positive and PCR-negative CSF specimens by microchip electrophoresis. Unincorporated primers contained in the PCR reaction create a peak preceding the expected 111-bp HSV PCR product.

fragments from the variable region of the T-cell receptor- γ gene (150–250 bp range) and the immunoglobulin heavy chain gene (80–140 bp range), yielding diagnostically relevant information regarding the presence of clonal DNA populations. A silicon glass microchip was used to separate the locus-specific, multiplex PCR products specific for deletions causing Duchenne/Becker muscular dystrophy.⁹⁰ Single-channel capillary electrophoresis microchips were used to analyze fluorescently labeled CTTv PCR samples and short tandem repeats.⁹¹ DNA sequencing was first demonstrated on glass microchips with a polyacrylamide sieving matrix.⁹² DNA sequencing fragment ladders fluorescent-labeled with energy transfer dye primers were single base resolved up to 150–200 bases in 10–15 min on a 3.5-cm long separation channel. Using a single-color detector, DNA sequencing was also achieved in less than 14 min on a single-channel microchip 11.5 cm long with a read length of 400 bases.⁹³ A read length of over 500 bases at 99.4% accuracy was obtained on a single-channel microchip with a linear polyacrylamide matrix in about 20 min using four-color detection.⁹⁴ DNA sequencing in parallel on a 16-channel microchip was demonstrated recently, yielding more than 450 bases in 15 min in all 16 channels at an accuracy of >99% using four-color detection.⁹⁵ DNA sequencing in a 48-channel 50-cm-long monolithic device was presented,⁹⁶ single-base resolution greater than 600 bases was achieved, and the sequence base called to 640 bases with 98% accuracy.

Among DNA-based drugs, only antisense DNA is currently analyzed by capillary electrophoresis. Antisense DNA therapy requires reliable and convenient methods for sequencing short single-stranded oligonucleotides. A method for phosphorothioate antisense DNA sequencing by capillary electrophoresis coupled to UV detection has been developed based on a modified chain-termination sequencing method.⁹⁷ Capillary gel electrophoresis alone or in combination with HPLC is also used for pharmacokinetics study of antisense

DNA.⁹⁸ As summarized above, microfabricated electrophoresis devices have been demonstrated to be a powerful tool in DNA analysis; microchip electrophoresis techniques possess great potential for DNA-based drug analysis and will be a highly recommended separation tool for such purpose.

V. CONCLUDING REMARKS

Although this review has tapped only a small fraction of the literature that has already shown the potential utility of CE and microchip technology, it is clear that this is the beginning of an era in which microminiaturized separation technology will not only survive, but flourish. The reasons for this are obvious: the ability to perform separations faster with the reduced sample/reagent consumption associated with microchips, together with the possibility of integrating sample processing on the same platform—these have obvious applications in areas ranging from drug discovery to forensics. Clearly, there are serious engineering obstacles to be overcome for the full potential of this technology to be realized, but these will be resolved through multidisciplinary approaches via collaborations between engineers, chemists, and biologists.

VI. SUMMARY

Microchip electrophoresis evolved from capillary electrophoresis, which is regarded as a hybrid form of electrophoresis and chromatography, and is a promising miniaturization technology. The potential to integrate many functions into a single device, minute consumption of sample and reagent, and the capability to analyze a wide variety of molecules have made microchip electrophoresis an ideal candidate for the future generation of separation technology that has impacts on various aspects including the pharmaceutical industry. Interdisciplinary collaborations at this point are essential and critical to turn it into a mature technique, a valuable member of the separation science family.

REFERENCES

1. Skoog, D. A., West, D. M., and Holler, F. J. *Fundamentals of Analytical Chemistry*, 7th ed., Saunders College Publishing, Philadelphia, 1996.
2. Jones, A. J. and Martin, A. J. P. Gas-liquid partition chromatography: a technique for the analysis of volatile materials. *Analyst* 77:915–918, 1952.
3. Snyder, L. R. and Kirkland, J. J. *Introduction to High Performance Liquid Chromatography*, 2nd ed., Chapman and Hall, London, 1982.
4. Mikkers, F., Everaerts, F., and Verheggen, T. High performance zone electrophoresis. *J. Chromatogr.* 69:11–20, 1979.
5. Jorgenson, J. W. and Lukacs, K. D. Zone electrophoresis in open tubular glass capillaries. *Anal. Chem.* 53:1298–1302, 1981.
6. Veraart, J. R., Lingeman, H., and Brinkman, U. A. Coupling of biological sample handling and capillary electrophoresis. *J. Chromatogr. A* 856:483–514, 1999.

7. Boone, C. M., Waterval, J. M., Lingeman, H., Ensing, K., and Underberg, W. J. Capillary electrophoresis as a versatile tool for the bioanalysis of drugs—a review. *J. Pharm. Biomed.* 20:831–863, 1999.
8. Anderson, B. B. and Ewing, A. G. Chemical profiles and monitoring dynamics at an individual nerve cell in *Planorbis corneus* with electrochemical detection. *J. Pharm. Biomed.* 19:15–32, 1999.
9. Manetto, G., Crivellente, F., and Tagliaro, F. Capillary electrophoresis: a new analytical tool for forensic toxicologists. *Ther. Drug Monit.* 22:84–88, 2000.
10. Krylov, S. N. and Dovichi, N. J. Capillary electrophoresis for the analysis of biopolymers. *Anal. Chem.* 72:111R–128R, 2000.
11. Ren, J. C. High-throughput single-strand conformation polymorphism analysis by capillary electrophoresis. *J. Chromatogr. B* 741:115–128, 2000.
12. Oda, R. P. and Landers, J. P. Introduction to capillary electrophoresis. In *Handbook of Capillary Electrophoresis* (J. P. Landers, Ed.), 2nd ed., pp. 1–47. CRC Press, New York, 1997.
13. Shi, Y., Simpson, P. C., Scherer, J. R., Wexler, D., Skibola, C., Smith, M. T., and Mathies, R. A. Radial capillary array electrophoresis microplate and scanner for high-performance nucleic acid analysis. *Anal. Chem.* 71:5354–5361, 1999.
14. Ferrance, J. P., Giordano, B. C., and Landers, J. P. Towards effective PCR-based amplification of DNA on microfabricated chips. In *Capillary Electrophoresis of Nucleic Acids* (K. R. Mitchelson and J. Cheng, Eds.). Humana Press, Clifton, NJ, 2001.
15. Manz, A., Harrison, J. D., Verpoorte, E. M. J., Fettingner, J. C., Paulus, A., Ludi, H., and Widmer, H. M. J. Planar chips technology for miniaturization and integration of separation techniques into monitoring systems—capillary electrophoresis on a chip. *J. Chromatogr.* 593:253–258, 1992.
16. Harrison, D. J., Manz, A., Fan, Z., Ludi, H., and Widmer, H. M. Capillary electrophoresis and sample injection systems integrated on a planar glass chip. *Anal. Chem.* 64:1926–1932, 1992.
17. Harrison, D. J., Fluri, K., Seiler, K., Fan, Z., Effenhauser, C. S., and Manz, A. Micromachining a miniaturized capillary electrophoresis-based chemical-analysis system on a chip. *Science (Washington, D.C.)* 261:895–897, 1993.
18. Jacobson, S. C., Hergenroder, R., Koutny, L. B., Warmack, R. J., and Ramsey, J. M. Effects of injection schemes and column geometry on the performance of microchip electrophoresis devices. *Anal. Chem.* 66:1107–1113, 1994.
19. Effenhauser, C. S., Manz, A., and Widmer, H. M. Glass chips for high-speed capillary electrophoresis separations with submicrometer plate heights. *Anal. Chem.* 65:2637–2642, 1993.
20. Khandurina, J., Jacobson, S. C., Waters, L. C., Foote, R. S., and Ramsey, J. M. Microfabricated porous membrane structure for sample concentration and electrophoretic analysis. *Anal. Chem.* 71:1815–1819, 1999.
21. Muller, O., Hahnenberger, K., Dittmann, M., Yee, H., Dubrow, R., Nagle, R., and Ilsley, D. A microfluidic system for high-speed reproducible DNA sizing and quantitation. *Electrophoresis* 21:128–134, 2000.
22. Woolley, A. T., Sensabaugh, G. F., and Mathies, R. A. High-speed DNA genotyping using microfabricated capillary array electrophoresis chips. *Anal. Chem.* 69:2181–2186, 1997.
23. Foret, F., Zhang, B., and Karger, B. L. Design of an integrated system for automated high throughput CE-ESI/MS using microfluidics. Poster, HPCE 2000, Sarbrücken, Germany.
24. Smith, E. M., Xu, H., and Ewing, A. G. DNA separations in microfabricated partitioned channels with automated capillary sample introduction. *Electrophoresis* 22:363–370, 2001.
25. Terry, S. C., Jerman, J. H., and Angell, J. B. A gas chromatographic air analyzer fabricated on a silicon wafer. *IEEE Trans. Electron Devices* 26:1880–1886, 1979.
26. Salimi-Moosavi, H., Jiang, Y. T., Lester, L., McKinnon, G., and Harrison, D. J. A multireflection cell for enhanced absorbance detection in microchip-based capillary electrophoresis devices. *Electrophoresis* 21:1291–1299, 2000.
27. Koutny, L. B., Schmalzing, D., Taylor, T. A., and Fuchs, M. Microchip electrophoretic immunoassay for serum cortisol. *Anal. Chem.* 68:18–22, 1996.
28. Jacobson, S. C. and Ramsey, J. M. Microchip electrophoresis with sample stacking. *Electrophoresis* 16:481–486, 1995.

29. Fluri, K., Fitzpatrick, G., Chiem, G. N., and Harrison, D. J. Integrated capillary electrophoresis devices with an efficient postcolumn reactor in planar quartz and glass chips. *Anal. Chem.* 68:4285–4290, 1996.
30. Becker, H., Lowack, K., and Manz, A. Planar quartz chips with submicron channels for two-dimensional capillary electrophoresis applications. *J. Micromech. Microeng.* 8:24–28, 1998.
31. Becker, H. and Gartner, C. Polymer microfabrication methods for microfluidic analytical applications. *Electrophoresis* 21:12–26, 2000.
32. McDonald, J. C., Duffy, D. C., Anderson, J. R., Chiu, D. T., Wu, H., Schueller, O. J. A., and Whitesides, G. M. Fabrication of microfluidic systems in poly (dimethylsiloxane). *Electrophoresis* 21:27–40, 2000.
33. Park, S., Lunte, S. M., and Lunte, C. E. A perfluorosulfonated ionomer joint for capillary electrophoresis with on-column electrochemical detection. *Anal. Chem.* 67:911–918, 1995.
34. Andrews, D. L. and Demidov, A. A. *An Introduction to Laser Spectroscopy*, pp. 1–62. Plenum, New York, 1995.
35. Pfab, J. Laser-induced fluorescence spectroscopy. In *Applied Laser Spectroscopy* (D. L. Andrews, Ed.), pp. 111–184. VCH, Weinheim/New York, 1992.
36. Pentony, S. L. and Sweedler, J. V. Optical detection techniques for capillary electrophoresis. In *Handbook of Capillary Electrophoresis* (J. P. Landers, Ed.), pp. 147–184. CRC Press, Boca Raton, FL, 1993.
37. Swerdlow, H., Zhang, J. Z., Chen, D. Y., Harke, H. R., Grey, R., Wu, S. L., and Dovichi, N. J. Three DNA sequencing methods using capillary gel electrophoresis and laser-induced fluorescence. *Anal. Chem.* 63:2835–2841, 1991.
38. Huang, X. C., Quesada, M. A., and Mathies, R. A. Capillary array electrophoresis using laser-excited confocal fluorescence detection. *Anal. Chem.* 64:967–972, 1992.
39. Simpson, P. C., Roach, D., Woolley, A. T., Thorsen, T., Johnston, R., Sensabaugh, G. F., and Mathies, R. A. High-throughput genetic analysis using microfabricated 96-sample capillary array electrophoresis microplates. *Proc. Natl. Acad. Sci. U.S.A.* 95:2256–2261, 1998.
40. Huang, Z., Munro, N., Huhmer, A. F. R., and Landers, J. P. Acousto-optical deflection-based laser beam scanning for fluorescence detection on multichannel electrophoretic microchip. *Anal. Chem.* 71:5309–5314, 1999.
41. Kheterpal, I., Scherer, J. R., Radhakrishnan, A., Ju, J. Y., Ginther, C. L., Sensabaugh, G. F., and Mathies, R. A. DNA sequencing using a four-color confocal fluorescence capillary array scanner. *Electrophoresis* 17:1852–1859, 1996.
42. Xue, Q. F., Dunayevskiy, Y. M., Foret, F., and Karger, B. L. Multichannel microchip electrospray mass spectrometry. *Anal. Chem.* 69:426–430, 1997.
43. Zhang, B., Liu, H., Karger, B. L., and Foret, F. Microfabricated devices for capillary electrophoresis–electrospray mass spectrometry. *Anal. Chem.* 71:3258–3264, 1999.
44. Zhang, B., Foret, F., and Karger, B. L. A microdevice with integrated liquid junction for facile peptide and protein analysis by capillary electrophoresis/electrospray mass spectrometry. *Anal. Chem.* 72:1015–1022, 2000.
45. Ramsey, R. S. and Ramsey, J. M. Generating electrospray from microchip devices using electroosmotic pumping. *Anal. Chem.* 69:1174–1178, 1997.
46. Lazar, I. M., Ramsey, R. S., Sundberg, S., and Ramsey, J. M. Subattomole-sensitivity microchip nanoelectrospray source with time-of-flight mass spectrometry detection. *Anal. Chem.* 71:3627–3631, 1999.
47. Figeys, D., Ning, Y., and Aebersold, R. A microfabricated device for rapid protein identification by microelectrospray ion trap mass spectrometry. *Anal. Chem.* 69:3153–3160, 1997.
48. Figeys, D. and Aebersold, R. Nanoflow solvent gradient delivery from a microfabricated device for protein identifications by electrospray ionization mass spectrometry. *Anal. Chem.* 70:3721–3727, 1998.
49. Figeys, D., Gygi, S. P., McKinnon, G., and Aebersold, R. An integrated microfluidics–tandem mass spectrometry system for automated protein analysis. *Anal. Chem.* 70:3728–3734, 1998.
50. Pinto, D. M., Ning, Y., and Figeys, D. An enhanced microfluidic chip coupled to an electrospray Qstar mass spectrometer for protein identification. *Electrophoresis* 21:181–190, 2000.

51. Little, D. P., Cornish, T. J., O'Donnell, M. J., Braun, A., Cotter, R. J., and Koster, H. MALDI on a chip: analysis of arrays of low-femtomole to subfemtomole quantities of synthetic oligonucleotides and DNA diagnostic products dispensed by a piezoelectric pipet. *Anal. Chem.* 69:4540–4546, 1997.
52. Xu, N., Lin, Y., Hofstadler, S. A., Matson, D., Call, C. J., and Smith, R. D. A microfabricated dialysis device for sample cleanup in electrospray ionization mass spectrometry. *Anal. Chem.* 70:3553–3556, 1998.
53. Xiang, F., Lin, Y., Wen, J., Matson, D. W., and Smith, R. D. An integrated microfabricated device for dual microdialysis and on-line ESI-ion trap mass spectrometry for analysis of complex biological samples. *Anal. Chem.* 71:1485–1490, 1999.
54. Wen, J., Lin, Y., Xiang, F., Matson, D. W., Udseth, H. R., and Smith, R. D. Microfabricated iso-electric focusing device for direct electrospray ionization–mass spectrometry. *Electrophoresis* 21:191–197, 2000.
55. Li, J., Thibault, P., Bings, N. H., Skinner, C. D., Wang, C., Colyer, C., and Harrison, J. Integration of microfabricated devices to capillary electrophoresis–electrospray mass spectrometry using a low dead volume connection: application to rapid analyses of proteolytic digests. *Anal. Chem.* 71:3036–3045, 1999.
56. Li, J., Kelly, J. F., Chernushevich, I., Harrison, D. J., and Thibault, P. Separation and identification of peptides from gel-isolated membrane proteins using a microfabricated device for combined capillary electrophoresis/nanoelectrospray mass spectrometry. *Anal. Chem.* 72:599–609, 2000.
57. Li, J., Wang, C., Kelly, J. F., Harrison, D. J., and Thibault, P. Rapid and sensitive separation of trace level protein digests using microfabricated devices coupled to a quadrupole-time-of-flight mass spectrometer. *Electrophoresis* 21:198–210, 2000.
58. Licklider, L., Wang, X. Q., Desai, A., Tai, Y. C., and Lee, T. D. A micromachined chip-based electrospray source for mass spectrometry. *Anal. Chem.* 72:367–375, 2000.
59. Wang, A. and Fang, Y. Applications of capillary electrophoresis with electrochemical detection in pharmaceutical and biomedical analyses. *Electrophoresis* 21:1281–1290, 2000.
60. Woolley, A. T., Lao, K., Glazer, A. N., and Mathies, R. A. Capillary electrophoresis chips with integrated electrochemical detection. *Anal. Chem.* 70:684–688, 1998.
61. Rossier, J. S., Roberts, M. A., Ferrigno, R., and Girault, H. H. Electrochemical detection in polymer microchannels. *Anal. Chem.* 71:4294–4299, 1999.
62. Ford, S. M., Dar, B., McWhorter, S., Davies, J., Soper, S. A., Klopff, M., Calderon, G., and Saile, V. Microcapillary electrophoresis devices fabricated using polymeric substrates and X-ray lithography. *J. Microcolumn Sep.* 10:413–422, 1998.
63. Hubner, J., Friis, P., Mogensen, K. B., Petersen, N. J., and Kutter, J. P. Integrating separation systems and optical detection on microfabricated devices. Poster, HPCE2000, Sarbrücken, Germany.
64. Wendt, J. R., Warren, M. E., Sweatt, W. C., Bailey, C. G., Matzke, C. M., Arnold, D. W., Allerman, A. A., Carter, T. R., Asbill, R. E., and Samora, S. Fabrication of high performance microlenses for an integrated capillary channel electrochromatograph with fluorescence detection. *J. Vac. Sci. Technol. B* 17:3252–3255, 1999.
65. Bailey, C. G., Wallenborg, S. R., Arnold, D. W., Warren, M. E., Sweatt, W. C., Wendt, J. R., and Kemme, S. A. Integrated laser induced fluorescence detection in chip based separations. Poster, HPCE2000, Sarbrücken, Germany.
66. Munro, N. J., Huang, Z., Finegold, D. N., and Landers, J. P. Indirect fluorescence detection of amino acids on electrophoretic microchips. *Anal. Chem.* 72:2765–2773, 2000.
67. Wallenborg, S. R. and Bailey, C. G. Separation and detection of explosives on a microchip using micellar electrokinetic chromatography and indirect laser-induced fluorescence. *Anal. Chem.* 72:1872–1878, 2000.
68. Hutt, L. D., Glavin, D. P., Bada, J. L., and Mathies, R. A. Microfabricated capillary electrophoresis amino acid chirality analyzer for extraterrestrial exploration. *Anal. Chem.* 71:4000–4006, 1999.
69. Rodriguez, I., Jin, L. J., and Li, S. F. Y. High-speed chiral separation on microchip electrophoresis devices. *Electrophoresis* 21:211–219, 2000.
70. Wallenborg, S. R., Lurie, I. S., Arnold, D. W., and Bailey, C. G. On-chip chiral and achiral separation of amphetamine and related compounds labeled with 4-fluoro-7-nitrobenzofurazane. *Electrophoresis* 21:3257–3263, 2000.

71. Liang, Z. H., Chiem, N., Ocvirk, G., Tang, T., Fluri, K., and Harrison, D. J. Microfabrication of a planar absorbance and fluorescence cell for integrated capillary electrophoresis devices. *Anal. Chem.* 68:1040–1046, 1996.
72. Dunn, M. J. (Ed.). *Electrophoresis*, Proteomic Reviews, Issue 6. Wiley-VCH, Weinheim/New York, 2000.
73. Simpson, R. J. (Ed.). *Electrophoresis*, IPPC'99, Issue 9. Wiley-VCH, Weinheim/New York, 2000.
74. Anderson, L., Witzmann, F., Langen, H., and Steiner, S. (Eds.). *Electrophoresis*, Pharmaceutical Proteomics, Issue 11. Wiley-VCH, Weinheim/New York, 2000.
75. Dunn, M. J. and Gorg, A. (Eds.). *Electrophoresis*, Proteomics Forum '99, Issue 13. Wiley-VCH, Weinheim/New York, 2000.
76. Karp, G. *Cell and Molecular Biology, Concepts and Experiments*, 2nd ed., pp. 491–492. Wiley, New York, 1999.
77. Baba, Y. Analysis of disease-causing genes and DNA-based drugs by capillary electrophoresis—towards DNA diagnosis and gene therapy for human diseases. *J. Chromatogr. B* 687:271–302, 1996.
78. Effenhauser, C. S., Paulus, A., Manz, A., and Widmer, H. M. High-speed separation of anti-sense oligonucleotides on a micromachined capillary electrophoresis device. *Anal. Chem.* 66:2949–2953, 1994.
79. Woolley, A. T. and Mathies, R. A. Ultra-high-speed DNA fragment separations using microfabricated capillary array electrophoresis chips. *Proc. Natl. Acad. Sci. U.S.A.* 91:11348–11352, 1994.
80. McCormick, R. M., Nelson, R. J., Alonso-Amigo, M. G., Benvegna, J., and Hoopwer, H. H. Microchannel electrophoretic separations of DNA in injection-molded plastic substrates. *Anal. Chem.* 69:2626–2630, 1997.
81. Effenhauser, C. S., Bruin, G. J. M., Paulus, A., and Ehrat, M. Integrated capillary electrophoresis on flexible silicone microdevices: analysis of DNA restriction fragments and detection of single DNA molecules on microchips. *Anal. Chem.* 69:3451–3457, 1997.
82. Duffy, D. C., McDonald, J. C., Schueller, O. J. A., and Whitesides, G. M. Rapid prototyping of microfluidic systems in poly(dimethylsiloxane). *Anal. Chem.* 70:4974–4984, 1998.
83. Effenhauser, C. S., Bruin, G. J. M., and Paulus, A. Integrated chip-based capillary electrophoresis. *Electrophoresis* 18:2203–2213, 1997.
84. Ogura, M., Agata, Y., Watanabe, K., McCormick, R. M., Hamaguchi, Y., Aso, Y., and Mitsuhashi, M. RNA chip: quality assessment of RNA by microchannel linear gel electrophoresis in injection-molded plastic chips. *Clin. Chem.* 44:2249–2255, 1998.
85. Simpson, P. C., Roach, D., Woolley, A. T., Thorsen, T., Johnston, R., Sensabaugh, G. F., and Mathies, R. A. High-throughput genetic analysis using microfabricated 96-sample capillary array electrophoresis microplates. *Proc. Natl. Acad. Sci. U.S.A.* 95:2256–2261, 1998.
86. Tian, H. J., Jaquins-Gerstl, A., Munro, N., Trucco, M., Brody, L. C., and Landers, J. P. Single-strand conformation polymorphism analysis by capillary and microchip electrophoresis: a fast, simple method for detection of common mutations in BRCA1 and BRCA2. *Genomics* 63:25–34, 2000.
87. Hofgartner, W. T., Huhmer, A. F. R., Landers, J. P., and Kant, J. A. Rapid diagnosis of herpes simplex encephalitis using microchip electrophoresis of PCR products. *Clin. Chem.* 45:2120–2128, 1999.
88. Chen, Y. H., Wang, W. C., Young, K. C., Chang, T. T., and Chen, S. H. Plastic microchip electrophoresis for analysis of PCR products of hepatitis C virus. *Clin. Chem.* 45:1938–1943, 1999.
89. Munro, N., Snow, K., Kant, J. A., and Landers, J. P. Molecular diagnostics on microfabricated electrophoretic devices: from slab gel- to capillary- to microchip-based assays for T- and B-cell lymphoproliferative disorders. *Clin. Chem.* 45:1906–1917, 1999.
90. Cheng, J., Waters, L. C., Fortina, P., Hvichia, G., Jacobson, S. C., Ramsey, M., Kricka, L. J., and Wilding, P. Degenerate oligonucleotide primed polymerase chain reaction and capillary electrophoretic analysis of human DNA on microchip-based devices. *Anal. Biochem.* 257:101–106, 1998.
91. Schmalzing, D., Koutny, L., Adourian, A., Belgrader, P., Matsudaira, P., and Ehrlich, D. DNA typing in thirty seconds with a microfabricated device. *Proc. Natl. Acad. Sci. U.S.A.* 94:10273–10278, 1997.

92. Woolley, A. T. and Mathies, R. A. Ultra-high-speed DNA-sequencing using capillary electrophoresis chips. *Anal. Chem.* 67:3676–3680, 1995.
93. Schmalzing, D., Adourian, A., Koutny, L., Ziaugra, L., Matsudaira, P., and Ehrlich, D. DNA sequencing on microfabricated electrophoretic devices. *Anal. Chem.* 70:2303–2310, 1998.
94. Liu, S. R., Shi, Y., Ja, W. W., and Mathies, R. A. Optimization of high-speed DNA sequencing on microfabricated capillary electrophoresis channels. *Anal. Chem.* 71:566–573, 1999.
95. Liu, S. R., Ren, H. J., Gao, Q. F., Roach, D. J., Loder, R. T., Armstrong, T. M., Mao, Q. L., Blaga, I., Barker, D. L., and Jovanovich, S. B. Automated parallel DNA sequencing on multiple channel microchips. *Proc. Natl. Acad. Sci. U.S.A.* 97:5369–5374, 2000.
96. Backhouse, C., Caamano, M., Oaks, F., Nordman, E., Carrillo, A., Johnson, B., and Bay, S. DNA sequencing in a monolithic microchannel device. *Electrophoresis* 21:150–156, 2000.
97. Froim, D., Hopkins, C. E., Belenky, A., and Cohen, A. S. Method for phosphorothioate anti-sense DNA sequencing by capillary electrophoresis with UV detection. *Nucleic Acids Res.* 25:4219–4223, 1997.
98. Chen, S. H. and Gallo, J. M. Use of capillary electrophoresis methods to characterize the pharmacokinetics of antisense drugs. *Electrophoresis* 19:2861–2869, 1998.

INDEX

- Abbreviated new drug application (ANDA), 7, 174, 179–180
- Absolute configuration, 5
- Absorption, 32
- Absorption, distribution, metabolism, and excretion (ADME), 28–30
- combinatorial library design, 37–38
- existing computational methods, 30–35
- future of, 38–39
- Acceptance criteria, 491
- parenteral drug products, 299–300
- Accuracy, definition, 418
- Accurate mass, 136
- measurements, 145–146
- Acid/base studies, 99–101
- Acidic/basic solutes, 353
- Actinometry, in photostability testing, 109
- Active pharmaceutical ingredients (API), 1, 235
- description tests, 328
- identification testing, 328–329, 331–333
- in parenteral drug forms, 271
- solid oral dosage forms and, 329
- Actual mass flow rates, 79
- Adduct ions, 136–137
- Admixture studies, parenteral drug products, 282–283
- Alcohols, acid/base hydrolysis, 99–101
- Alphanumeric labeling, 27
- Alternative analytical procedures, chemical substances, 396–397
- Amides, acid/base hydrolysis, 99–101
- Amorphous powders, drug substance, 204
- Analyst certification and training, 494
- Analytical development report, 517–518
- Analytical documentation
- IND-enabling, 506
- quality assurance review, 519
- Analytical documents, key product-specific, during development, 503
- Analytical group, role in solid dosage forms, 238
- Analytical methodology transfer, 10, 19–21, 485–498
- types, 487–489
- Analytical method validation, 9, 415–443
- interrelated elements to ensure reliability, 417–418
- Analytical profiles, new drug, 186–189
- Analytical techniques, in new drug development, 178
- Analytical technology transfer, requirements and elements, 489–491
- Analytical variability, in setting specifications, 412
- Angle of difference, 79
- Angle of fall, 79
- Angle of repose, 79

- Angle (*Continued*)
in drug substance identification, 194
- Angle of spatula, 79
- Animal health products, 185
- Anisotropic crystals, 66
- Anticancer drugs, delivery and dosing of, 312–313
- Antioxidants, 105
phenolic, 106
- Antisense DNA, analyzed by CE, 548
- APCI vs ESP, 133–135
- Artifact-based technologies, in sterility testing of parenteral drugs, 287–289
- Aryl amines, acid/base hydrolysis, 99–101
- Assay plate formats, 40–42
- Assays, in compendial testing, 333–335
- Atlas Suntest Tabletop Sunlight Exposure System, in photostability testing, 108
- Atomic absorption, in preformulation studies, 219
- Atomic emission spectrometer, inductively coupled plasma with, 219
- Audits and inspections, in stability studies, 460
- Autoxidation chain reaction, 104–105
- Bacterial endotoxin testing, parenteral dosage forms, 289–292
- Bacteriostasis and fungistasis testing, 286–287
- Batch selection, in drug substance stability programs, 464–465
- Benzyl alcohol, in parenteral formulations, 277
- BET method, 77
- Biaxial crystals, 66
- Biliary excretion, 35
- Bioavailability, in preformulation studies, 176
- Bioavailability/dissolution requirements, 4
- Bioburden testing, parenteral drug solution, 294–297
- Biological activity, biotechnological/biological products, 403
- Biological license application (BLA), 183
- Biopharmaceutical classification, in discovery phase, 502
- Biopharmaceutical properties, of a drug substance, 205–208
- Biotechnological/biological products
analytical considerations, 403
compendial specifications, 403
process-related considerations, 403
quality of, 9
release vs shelf life limits, 404
statistical concepts, 404
test procedures and acceptance criteria for, 402–405
- Biotechnology-derived products, stability of, 213
- Biotechnology products, preformulation studies, 183–184
- Blend homogeneity, solid dosage-form analysis, 256–257
- Blood-brain barrier (BBB), penetration of, 32–33
- Bonding index, 80
- Botanicals, 184
- Bracketing, 477–478
- Bradykinin-1, identification of receptor antagonists for, 44–47
- Brittle fracture index, 80
- Buccal cavity, absorption of drugs, 308
- Bulk density, 78
in drug substance identification, 194
- Bulk holding studies, drug products intermediates, 478
- Bulk level, properties associated with, 73–81
- CAMEO, in degradation prediction, 113
- Cancer, drug delivery in, 311–313
- Candidate screening, 502–504
- Capillary electrophoresis (CE), 530
microchip, 531
pharmaceutical potential, 544–548
separation methods, 379–382
as separation technique, 221
- Carbamates, acid/base hydrolysis, 99–101
- Carr flowability, 79–80
- Charge-coupled device (CCD)
camera, detection in electrophoresis, 537
- Chemical ionization, 129
- Chemical properties, in drug substance identification, 189–190
- Chemical substances, setting of specifications for, 395
- Chemical testing, parenteral drug products, 272–273
- Chemistry, manufacturing and control (CMC), 5–6
global NDA, 515–516
IND information, 512–513
relevant guidances, 522–524
- Chemokine receptor, identification of receptor antagonists for, 44–47
- Chemunex ChemScan RDI system, 288
- Chiral centers, 5
- Chiral components, identification in preformulation studies, 187
- Chiral compound, 175
- Chirality, in compound selected for development, 175
- Chiral separations, 372–374
achieved by CE, 545–546
- Chiral stationary phases (CSPs), 372
- Chromatography. *see* specific type
- Circular dichroism (CD), identification of chiral compounds, 187
- Cleaning method validation, parenteral drug products, 282–283
introduction, 297–298
- Climate zones, in stability studies, 448
- Clinical candidate selection, 504
- Clinical drug development, four phases, 3
- Clinical trial studies, 178–179
- Cluster ions, 136–137
- Cohesion, 79
- Collision energy dependence, 141–142
- Colon, drug delivery, 309
- Color, perception of, 59
- Combinatorial chemistry, 2
in drug discovery and development, 23–56
high-throughput screening and, 39–40
- Combinatorial libraries
design, ADME models, 37–38
with optimal ADME properties, 28–30
receptor antagonists for chemokine receptor and bradykinin-1, 44–47

- Combinatorial methods, 25–26
- Commission Internationale de l'Eclairage (CIE) system, 59
- Common technical document (CTD), 9
- global CMC NDA, 515–516
- Comparative testing, 488
- Compatibility studies, drug substances, 208–209
- Compendial analytical procedures, 428
- Compendial testing, 10, 15–16, 325–344
- formulated products and active ingredients, 327–339
- testing methods for multicountry submission, 341–343
- validation, 340–341
- which compendium to use and when to use it, 339–340
- Compliance, CMC guidances for, 523
- Compliance documents, 8, 516–520
- Compound optimization, historical sequential process of, 36
- Comprehensive Medicinal Chemistry Database (CMC), 31
- Compressibility, 79
- Compression properties, in drug substance identification, 195
- Confirmatory testing, in photostability testing, 107
- Conformational polymorphism, 69
- Container inspection machines, automatic, 292–293
- Conventional dosage forms, 179
- Cooled charge-coupled device (CCD), 41
- Copyrights, 177–178, 177–178
- Co-solvents, 95
- COSY, 157
- Covalidation, between two laboratories, 488
- Crohn's disease, drug delivery to the colon, 309
- Cross polarization (CP), 63
- Crystal form, 4, 5
- Crystal morphology, drug substance, 204–205
- Current good manufacturing practices (cGMP), 6, 178–179
- in preformulation studies, 224
- Customer evaluation testing, 422
- Cytochrome P450 isoenzymes, in drug metabolism, 34
- Data evaluation
- drug product stability testing, 478–479
- in drug substance stability programs, 470–471
- Deconvolution, 26
- Definitive clinical efficacy studies, in clinical drug development, 3
- Degradation
- forced, in drug substance identification, 210
- pharmaceutical drug candidates, 85–172
- Degradation-impurity process
- global perspective, 116–117
- reference standards, 166–168
- Degradation-impurity sample set, 114
- Degradation prediction, drug products and substances, 112
- Degradation products
- in drug substance identification, 188–189
- isolation and characterization, in drug substance identification, 210
- potential, in drug substance identification, 209
- Degradation samples, for method development, 113–116
- Degradation studies
- drug products, 110–113
- drug substance, 98–110
- drug substance and drug product comparison, 111
- purposeful, 95–117
- Derivatization of preformed functionalized scaffolds, 25
- Derwent World Drug Index (WDI), 31
- Description testing, identification testing, 328
- Design and development considerations, chemical substances, 396
- Detection limits, 432–433
- definition, 419
- Detection techniques, in electrophoresis, 535–544
- Deuterates solvents, in NMR, 152
- Developmental stability testing, in drug substance stability programs, 463–464
- Deviation report, documentation in stability studies, 455
- Dextrose, in parenteral formulations, 277
- Diazene free radical inhibitors, for pressured oxidation studies, 104
- Dietary supplement products, 184–185
- Dietary Supplements Educational and Health Act (DSEHA), 184
- Differential scanning calorimetry (DSC), 71–73, 189
- study of polymorphism, 201
- for thermal analysis, 222–223
- Differential thermal analysis (DTA), 71–72
- heat-flux, 72
- power compensation, 72
- Dimethoxypropane titration, examination of water amounts, 93
- Direct divide method, 26
- Direct inoculation method, sterility testing of parenteral drugs, 284
- Direct transfer method, sterility testing of parenteral drugs, 284
- Discovery phase, candidate screening, 502–504
- Disintegration tests, 4
- Dispersibility, 79
- Dissociation constant pK_{as} , in drug substance identification, 190
- Dissolution rates
- drug substance, 207
- study of polymorphism, 200
- Dissolution tests, 4
- Distortionless enhanced polarization transfer experiment (DEPT), 155–156
- Distribution, 32–33
- Diversity, 28
- DNA-based drugs, identification by CE, 546–547
- DNA strands, 27
- Documentation
- pharmaceutical analysis, 499–528
- in stability studies, 454–457
- Documentation and inspections, 10, 21
- Dosage forms, 3
- development and manufacturing of, 179
- development of, 10, 14–15
- selection of drug substances for, 175–177

- Dosage (*Continued*)
 mixing and blend uniformity, 195–196
 oral, 185–186
 parenteral (*see* Parenteral dosage)
 preformulation studies, 182
 solid, 57
 analysis, 235–268
 automation, 258–263
 data for supporting development for, 229–231
 future directions, 263
 physical stability of, 211
 physicochemical characterization techniques, 242–253
 quality-related regulatory and ICH influences, 238
 role of the analytical group, 238
 tests and specifications, 238–242
 solid oral
 active ingredients and, 329
 description tests, 328
 transdermal systems, 186
- Double refraction, 66
- Drug delivery systems (DDS), 307–324
 biodegradable, 313–315
 dermatological, 310–311
 devices, 319–323
 direct, 309–310
 implants, 321–322
 inhalers, 322–323
 oral, 308–309
 protein, 315–318
 special or novel, 185–186
 tumor-targeted, 311–313
- Drug development
 process, 7, 486–487
 stages of, 388–389
- Drug discovery and development
 combinatorial chemistry and high-throughput screening, 23–56
 success rates, 30
- Druglikeness, 28, 31
- Drug powder inhalers, 322
- Drug product life cycle
 discovery: candidate screening, 502–504
 pharmaceutical analysis during, 500–510
- Drug products, 1–2
 degradation studies, 110–113
 development of a new entity, 174
 formulated, compendial testing for, 327–339
 information filed with regulatory authorities, 6
 NDA documentation, 515
 new, specific tests and criteria, 399–402
 parenteral (*see* Parenteral drug products)
 preformulation study in support of development, 174–180
 single stability-indicating methods, 351
 specifications, biotechnological/biological products, 405
 stability, stress conditions for assessment of, 356
 stability studies, 471–479
 sterile, 269–305
- Drug-release tests, 4
- Drug substances, 1–2
 biopharmaceutical properties, 205–208
 chromatographic techniques, 227
 crystal morphology, 204–205
 degradation and impurity analysis of, 10, 12–13
 dissociation constant pK_a , 228
 dissolution rates, 207
 excipient compatibility studies, 208–209
 HPLC data, 228
 identification, 187–188, 227
 impact on drug product specifications, 397
 information filed with regulatory authorities, 6
 loss on drying, 229
 NDA documentation, 514
 new
 optically active, tests for, 399
 specific tests and criteria, 398–402
 optical rotation, 228
 particle size distribution, 205
 partition coefficient, 206, 228
 permeability in the GI tract, 206
 physicochemical properties and analytical testing, 226
 proposed assay methods, 227
 selection for dosage form development, 175–177
 single stability-indicating methods, 351
 solid-state analysis, 10, 11–12
 solubility, 228
 specifications, biotechnological/biological products, 404
 stability, 209–213
 stress conditions for assessment of, 356
 studies, 463–471
 synthetic impurities, 227
 titration methods, 227
 total surface area, 205
- Early-phase methods, 352–357
- Elastomeric materials, packaging for parenteral drug products, 274
- Electrical zone sensing, in particle size distribution, 74–77
- Electrochemical detection, 543
- Electron impact spectrum, 1,2-dimethylbenzene, 91
- Electron ionization (EI), 129–130
- Electron microscopy, 65
- Electrophoretic microchip technology, 529–554
- Electrospray ionization (ESI) mass spectrometer, 539
- Enantiomeric ratio, 5
- Enantiotopic interconversion, 67
- Encoding, 26–27
- Endotoxin contamination, in parenteral drug products, 291–292
- Entry into humans (EIH)/opening IND phase, 505–506
- Establishment license application (ELA), 183
- Esters, acid/base hydrolysis, 99–101
- Ethical, or prescription, products, 182
- European Commission (EC), 393
- European Federation of Pharmaceutical Industry Association (EFPIA), 393
- Evolving technologies, chemical substances, 397
- Exact mass, 136
- Excipients, 1–2
 examples of stability information, 462
 formulation development, 461
 probe stability, 461–462
 stability of, 461
 bound and unbound water, 462–463
- Excretion, 35

- Fast atom bombardment (FAB), 129
- Fast-dissolving tablets, 186
- Fiber-optic dissolution system, solid dosage-form analysis, 258–261
- Field desorption, 129
- Flame ionization detector, general residual solvent analysis, 89
- Flash chromatography (column chromatography), isolation of impurities/degradants, 122–123
- Floodable flow, 79
- Flow cytometers, detection in electrophoresis, 536
- Flow injection analysis, solid dosage-form analysis, 261–262
- Fluorescence degradation experimental setup, guidelines, 110
- Fluorescence exposure, 110
- Fluorescence microscopes, detection in electrophoresis, 536
- Fluorescence polarization (FP), 43
- Fluorescence resonance energy transfer (FRET), 43
- Fluorescence scanners, detection in electrophoresis, 536
- Food and Drug Administration (FDA), 3, 5, 394
- compendia testing, 326
- Formulated drug products, 1–2
- Fosinopril sodium, solid-state ¹³C-NMR spectra, 63–64
- Fourier-transform infrared microspectroscopy (FTIR), solid dosage-form analysis, 248–249
- Fourier-transform infrared spectroscopy (FTIR), 59–60
- Fourier transform mass spectrometry, 130
- Fraunhofer method, 76
- Full development decision point, 507
- Fusion curve for melting, 71
- Fuzzy adaptive least squares (FALS), model for druglikeness, 31
- Gas chromatography (GC)
- in residual solvents, 87
- separation methods, 347, 375
- as separation technique, 221–222
- in water, 93
- Gas chromatography-mass spectrometry, 90
- General inspections, 8
- General quality system documents, 516–517
- Generic or multisource products, 182–183
- Generic products and supplemental products, 448–449
- GI tract permeability, drug substance, 206
- Glass, substrate-based fabrication, 533–534
- Glass containers, parenteral drug products, 273
- Global CMC NDA, 9–10
- Good clinical practice (GCP), 178–179
- Good laboratory practices (GLP), 5
- non-good Ames test, 502
- in preformulation studies, 224
- Good manufacturing practices (GMP), 5
- in validation methods, 416
- Gradient elution, reversed-phase HPLC based on, 366
- Granddaughter ions, vs unimolecular degradation, 140–142
- Growth-based technologies, in sterility testing of parenteral drugs, 287–289
- Growth promotion testing, parenteral dosage forms, 286–287
- Headspace, solvents, 88
- Helicobacter pylori*, drug delivery to the stomach, 308–309
- Herbal products, 184
- HETCOR, 157
- Heteronuclear multiple bond correlation experiment (HMBC), 158
- Heteronuclear multiple quantum coherence (HMQC), 157
- Heteronuclear single quantum coherence (HSQC), 157
- High-performance liquid chromatography (HPLC), 25
- applicability of pharmaceutical applications, 349–350
- degradation samples, 97–98
- in drug substance identification, 187
- generalized validation process, 423
- normal-phase, 366–372
- phase-appropriate methods, 350–351
- preparative, isolation of impurities and degradants, 123–127
- in release testing of parenteral pharmaceuticals, 275–278
- reversed-phase, 364–366
- as separation technique, 221
- separation techniques, 237, 347
- High-performance liquid chromatography (HPLC)/mass spectrometry, 357–362
- High-performance liquid chromatography (HPLC)/nuclear magnetic resonance, 357–362
- High-throughput screening, 2
- combinatorial chemistry and, 39–40
- discovery of, 10–11
- in drug discovery and development, 23–56
- Hot stage microscopy
- study of polymorphism, 200
- for thermal analysis, 223
- Hydrates, of a drug substance, 202–204
- Hygroscopicity
- in drug substance identification, 193–194
- in preformulation studies, 176
- Ideal drug, 29
- Identification testing, solid oral dosage forms, 328–329, 331–333
- Identity and purity requirements, drug substances and drug products, 2–4
- Imides, acid/base hydrolysis, 99–101
- Imines, acid/base hydrolysis, 99–101
- Immunological properties, biotechnological/biological products, 403
- Implants, use in drug delivery, 321–322
- Impurities
- in compendial testing, 335–338
- identification with mass spectrometry, 127–147
- in method specificity, 430
- pharmaceutical drug candidates, 85–172

- Impurities/degradants
isolation and identification of, 117–127
isolation techniques, 121–126
- Impurity profile, in discovery phase, 502
- Impurity testing, 9
- Indirect detection, in electrophoresis, 544
- Infrared (IR) absorption spectroscopy, 60–61
- Infrared spectroscopy, in preformulation studies, 216
- Inhalers, use in drug delivery, 322–323
- Inhibition and enhancement testing, parenteral dosage forms, 290
- Injectable dosage forms (parenteral), analysis, 10, 14
- Inlet systems, 130–131
- Innovative analytical platforms, 10, 21–22
- In-process testing
chemical substances, 396
parenteral pharmaceuticals, 275
- Insulin
dermatological delivery, 318
ocular delivery, 318
oral delivery, 316–317
pulmonary delivery, 317
rectal delivery, 317–318
- Integrated detection system, in electrophoresis, 543–544
- Intellectual property protection and patent filing, 177–178
- Intermediate precision, definition, 418–419
- Internal methods, in discovery phase, 502
- International Conference on Harmonization (ICH), 9
background, 393–394
CMC guidances, 524
development and issuance of guidelines, 394–410
guideline on stability testing, 109
guidelines, 5, 95
guidelines on impurities in new drug products, 120
guidelines on impurities in new drug substances, 120
guidelines on setting specifications, 387
guidelines on validation, 416
impurities in new drug products, 95
mass balance, 114
preformulation studies, 224
quality-related regulatory influences, solid dosage forms, 238
regulatory guidelines, 448
residual solvents, 86
stability testing of new drug substances and products, 96
- International Federation of Pharmaceutical Manufacturers Association (IFPMA), 394
- Intestinal absorption, 32–33, 308
- Intraject, 319
- Intrinsic dissolution, 207
- Investigational new drug/clinical trial application stage, setting up specifications, 391
- Investigational new drug (IND) application, 174, 178
analytical documentation, 506
before clinical trials, 511–513
CMC guidances for, 522
CMC information, 512–513
meetings, 513
preparation and submission, 178
- Ion chromatography, as separation technique, 222
- Ion spectra, MS-MS product, 138–140
- Ion traps, 130
- Isocratic method development approach, 364
- Isotope patterns, in a mass spectrum, 137–140
- Isotropic extinction, 66
- Japanese Pharmaceutical Manufacturers Association (JPMA), 394
- Karl Fischer titrations, examination of water amounts, 93–95
- Lactic acid, in parenteral formulations, 277
- LAL test procedure, parenteral dosage forms, 290
variations and alternatives, 291
- Large-volume dosage forms, 271
- Laser-induced fluorescence, detection in electrophoresis, 536–538
- Laser light scattering, in particle size distribution, 74–77
- LC-MS mobile phases, 132–133
- Lead generation, 388
- Lead optimization, 388
- Limited data availability, chemical substances, 396
- Limit of detection (LOD)
method development, 357
in parenteral drug validation, 280
- Limit of quantitation (LOQ)
method development, 357, 367
in parenteral drug validation, 280
- Linearity
definition, 419
demonstration of, 430–431
- Lipinski's rule of 5 method, 31
- Lipopolysaccharides (LPSs), 289
- Liquid chromatography (LC), separation method, 347
- Loss on drying (LOD), solvents, 86
- Lyophilized dosage forms, 271
- M4, common technical dossier, 410
- Magic angle spinning (MAS) technique, 63
- Magnetic resonance spectrometry, 62–65
- Magnetic sector mass analyzer, 129–130
- Manufacturing variability, in setting specifications, 412
- Marketing phase, 509–510
- Mass balance, definition, 114
- Mass spectral fragmentation compendia, 146–147
- Mass spectrometry (MS), 189–190
in early phase development, 351–356
in electrophoresis, 538–543
identification of impurities, 127–147
flow chart, 128
not the universal detector, 131–132
in preformulation studies, 218
- Mass spectrum
interpreting for structure, 147
isotope patterns in, 138–140
- Matrix-assisted laser desorption/ionization time-of-flight (MALDI-TOF) MS, 540

- Matrixing and bracketing studies, drug product stability testing, 477–478
- Melting point, in drug substance identification, 187
- Membrane filtration method, sterility testing of parenteral drugs, 284
- META, 35
- Meta analysis, in preformulation studies, 218
- Metabisulfite analysis, in parenteral formulations, 277–278
- Metabolism, 34–35
- Metabolites, in compound selected for development, 177
- Metal chelator, 105–106
- Metered-dose inhalers (MDIs), 322
- Method accuracy, determination of, 433–434
- Method development, 10, 16–17, 118
drug substances and products, 345–385
purposeful degradation in, 113–116
- Method development life cycle, 419–422
- Method evaluation, 422
- Method modification, 422
- Method optimization, 424
- Method precision, determination of, 434
- Method procedure, 426–427
- Method robustness, 423–424
- Method specificity, 424–425
determination of, 429–430
- Methods/test procedures, analytical methodology transfer, 490
- Method transfer, 422, 436–437
documentation, 436
experimental, 437
protocol, 437
summary and approval, 437
- Method validation, 10, 18–19
and/or revalidation, 488
deliverables of the method development process, 423–427
method development and its influence, 419–427
- Microbiological testing, parenteral dosage forms, 283
- Microchip fabrication, design, 531–533
- Micrometrics, 77–78
- Microplate readers, detection in electrophoresis, 536
- Microprobes, in NMR, 151
- Microscopy, 65–67. *see also* specific type
physicochemical characterization of solid dosage forms, 242–244
- Millipore Microstar system, 288
- Miniaturization, 40–42
separation sciences, 529
- Ministry of Health and Welfare (MHW), Japan, 394
- Mobile-phase optimization
based on gradient runs, 366
based on isocratic runs, 364–366
- Moisture absorption/desorption, in drug substance identification, 193–194
- Molecular level, properties associated with, 58–65
- Molecular mass, monoisotopic vs chemical (average), 135–136
- Molecular oxygen, reaction of drug substance with, 103–107
- Molecular tags, 27
- Monoclonal antibody products
for in vivo use, biological licensing for, 183
- Monoisotopic vs chemical (average) molecular mass, 135–136
- Monotropic interconversion, 67
- MSI's Catalyst program, 35
- MS-MS product ion spectra, 138–140
- Multicolor detection system, in electrophoresis, 537
- Multicomponent condensation reactions, 25
- Multicountry submission,
harmonization of testing methods, 341–343
- Multimodal model-independent method, 76
- Multiply charged ions
EPS-generated, 142–143
polymer patterns vs, 143–145
- Multisource products, 182–183
- Nanoparticles, characteristics, 313–314
- Nasal route, drug delivery, 310
- Near-infrared (NIR)
in drug substance identification, 187
solid dosage-form analysis, 253–258
- Near-infrared (NIR) spectroscopy, use in parenteral drug testing, 279
- Nebulizers, 322
- Needle-free injectors, use in drug delivery, 319–321
- Neutraceuticals, 184
- Neutral solutes, 353
- New animal drug application (NADA), 185
- New chemical entity (NCE), 2
discovery of, 10–11
- New drug application (NDA), 174
analytical documentation, 509
CMC guidances for, 522–523
documentation, 514–515
documentation required for pre-NDA, 508
marketing authorization application stage, setting up specifications, 392–393
preparation of, 179
submission, approval and launch, 508–509
table of contents, 525–528
- New molecular entity (NME), 2
- Ninety-six-well microtiter format, 40
- NIR spectroscopy
examination of water amounts, 93
in preformulation studies, 217
- Nominal mass, 136
- Noncompendial methods, 428
- Nonseparation or homogeneous assays, 43–44
- Nuclear magnetic resonance (NMR) spectroscopy, 62
chemical structure, 189–190
data interpretation, 160–165
in early phase development, 351–356
examination of water amounts, 93
experiments, 154–160
additional, 158–160
one-dimensional, 154–155
two-dimensional, 156–158
information gathering, 148–150
instrumentation, 150–152
in preformulation studies, 217–218
role in degradation and impurity analysis, 147–165
flowchart, 148

- Nuclear (*Continued*)
sample preparation, 152–154
solid dosage-form analysis, 249–252
- Nucleic acid-based technologies, in sterility testing of parenteral drugs, 287–289
- Oblique extinction, 66
- One bead one compound, 26
- One-factor-at-a-time methodology (OFAT), 36
- Optical isomer, 5
- Optical microscopy, 65
in particle size distribution, 74–77
- Optical rotary dispersion (ORD), identification of chiral compounds, 187
- Optimization philosophy, 35–37
- Organic solvents, solubility in, 191–192
- Orthogonal spray devices, 132
- Osmolarity, in parenteral formulations, 278
- Out-of-specification reports, documentation in stability studies, 455–456
- Over-the-counter products (OTC), 184
- Oxidation
degradative studies, 103–107
guidance for experiments, 106
pressured studies, diazene free radical inhibitors for, 104
- Packaged clinical supplies, verification, NIR analysis, 254
- Packaging/containers, drug product stability testing, 475–476
- Packing polymorphism, 69
- Parallel extinction, 66
- Parametric release, chemical substances, 396
- Parenteral dosage forms, 269–305
bacterial endotoxin testing, 289–292
characteristics, 270–271
microbiological testing of, 283
particulate matter testing, 292–294
pharmaceutical analysis during formulation and development, 271–272
sterility testing, 284
- Parenteral drug products
acceptance criteria, 299–300
analytical testing for, 272–273
bioburden testing, 294–297
cleaning method validation, 282–283
cleaning validation, 297–298
grouping-matrix approach, 301–302
in-process testing, 275
methods of analysis, 301
method transfer, 281
package component testing for, 273–274
process development support, 274–275
release testing, 275–278
sampling, 299
stability-indicating, 281
swab selection, 298
technician qualification, 298–299
validation, 302
validation of analytical procedure, 279–281
- Partial least squares (PLS) modeling, 33
- Particle size distribution, 74–77
in a drug substance, 205
new drug substances, 398
in vivo applications of drug delivery systems, 314–315
- Particulate level, properties associated with, 65–73
- Particulate matter testing, parenteral dosage forms, 292–294
interpretation of results, 294
- Partition coefficient, of a drug substance, 206
- Patents, 177–178
- Peak purity, evaluation of, 430
- Peptides and proteins, identification by CE, 546
- Peptide strands, 27
- Periodic and skip testing, chemical substances, 396
- Pharmaceutical analysis
definition, 1
documentation in, 499–528
formulation and development of parenteral dosage forms, 271–272
modern, highlights of, 10
- Pharmaceutical and mechanical properties, in drug substance identification, 193–196
- Pharmaceutical potential, capillary electrophoresis, 544–548
- Pharmaceutical Research and Manufacturers of America (PhRMA), 394
- Pharmaceuticals, definition, 1
- Pharmaceutical test methods, validation of, 415–443
- Pharmacokinetic behavior, 5
- Pharmacopeial Forum, 327
- Pharmacopeias, specifications and, 410–411
- Pharmacopeial tests and acceptance criteria, chemical substances, 397
- Pharmacophore model, 34
- Pharmacopeial harmonization, 9
- Phase-appropriate methods, 3
- Phase I and Phase II studies, setting up specifications, 391–392
- Phases of development, 447–460
- Phase-solubility diagram, 189
- pH determination, in parenteral formulations, 278
- Photodiode array (PDA) detection, in early phase development, 354–356
- Photomultiplier tube (PMT), detection in electrophoresis, 537
- Photostability, 107–109
sample depth in, 109
- Physical classification, preformulation studies, 182
- Physicochemical properties
biotechnological/biological products, 402–403
new drug substances, 398
- Phytochemical products, stability of, 212–213
- Phytochemicals, 184
- Pivotal efficacy trials; pre-NDA planning/development phase, 507–508
- Plastic containers, parenteral drug products, 273
- Polarizing microscope, 66
- Polarizing optics, 66
- Polar surface area (PSA) models, 32–33
- Poly(dimethylsiloxane) (PDMA), 534–535
- Poly(ethylene glycol) (PEG) molecules, 143–144
- Polymer patterns, vs multiply charge ion series, 143–145
- Polymers, substrate-based fabrication, 534–535

- Polymorphism
 application in pharmaceutical development, 201–202
 in drug substance identification, 197–203
- Position scanning, 26
- Postpartal, CMC guidances for, 523
- Post-marketing changes, drug product stability testing, 479
- Post-new drug application (NDA) approval studies, in clinical drug development, 3, 5
- Powder characteristics, in drug substance identification, 194–195
- Powder characterization, 78–81
- Powdered solids, 57
- PowderJect, 320
- Preapproval inspection (PAI), 460
 analytical documentation, 509
 product-specific documents for, 517
 teams, QA personnel, 519–520
- Preapproved test plan, 489
- Precision, definition, 418
- Preclinical development/pre-entry into humans phase, 504–505
- Preclinical studies
 dosage forms, 390
 drug substance, 389–390
 enabling of, IND documentation, 511–512
 impurities and metabolites, 390
- Preformulation report
 analytical profiles, 186–189
 data supporting the development of dosage forms, 181
 format of, 213–214
 physicochemical properties and analytical testing for drugs, 181
 support for quality control and finished product manufacturing, 181–182, 231
- Preformulation studies, 10, 13, 173–234
 analytical method validation, 225
 analytical techniques and instruments for, 214–223
 documentation and standard operating procedures, 225
 drugs and health-care products, 182–186
 need for, 180
 other health care products, 186
- personnel qualification and training, 225
 quality control for, 225
 regulatory requirements for, 224–225
 separation sciences, 220–222
 stages of, 180–181
 support of new drug product development, 174–180
 thermal analytical methods, 222–223
- Preliminary validation experiments, 427
- Preparative HPLC, isolation of impurities and degradants, 123–127
- Primary degradation products, 115
- Probes, in NMR, 151
- Prodrugs, in compound selected for development, 176–177
- Product license application (PLA), 183
- Product realization, 388
- Product recalls, reasons for, 7
- Product-specific documents
 audit of, 8–9
 for PAI, 517
- Product-specific preapproval inspections, 8
- Proof of concept/safety studies, 506–507
- Proof of structure, 5
- Protein binding, to plasma proteins, 33
- Protocol and protocol amendments, documentation in stability studies, 454
- Protocols, in stability studies, 449–454
- Pseudomorphism, of a drug substance, 202–204
- Purge and trap, solvents, 88
- Purity
 absolute, in drug substance identification, 189
 in compound selected for development, 175
 in drug substance identification, 188–189
 impurity and contaminants, biotechnological/biological products, 403
- Purposeful degradation studies, 118
- Pyridine, in Karl Fischer titrations, 93
- Pyrogens, 289
- Pyrolysis, solvents, 88
- Q2, analytical method validation, 406
- Q3, impurities, 406–407
- Q4, pharmacopeial harmonization, 409–410
- Q5, guideline for biotechnological products, 410
- Q6A, chemical substances, 395–402
- Q6B, biotechnological/biological products, 402–405
- QI, stability testing, 405–406
- Quadrupole instruments, 129–130
- Quality assurance (QA), 2
 review of analytical documents, 519
- Quality control (QC), 2
 preformulation studies, 225, 231
- Quality control/quality assurance system, 179
- Quality-related regulatory influences, solid dosage forms, 238
- Quantitation limits, 432–433
 definition, 419
- Quartz, substrate-based fabrication, 533–534
- Racemate, 5
- Radiofrequency transponders, 27
- Raman spectroscopy, 60–61
 in preformulation studies, 216
 solid dosage-form analysis, 252–253
- Range
 definition, 419
 demonstration of, 430–431
- Raw materials
 identification, NIR analysis, 254–255
 testing, parenteral dosage forms, 278–279
- Rayonet RPR-200 photochemical reactors, in photostability testing, 108–109
- Reaction solvent, in oxidation reaction, 105
- Rectum
 absorption of drugs, 308
 administration of drugs, 310
- Reference standards, 438–441
 chemical substances, 397
 degradation and impurity analysis, 166–168
- Refraction, 66
- Regulatory classification, preformulation studies, 182

- Regulatory compliance, 8–9
Regulatory considerations, 5–7
Regulatory documents, IND and NDA submission, 510–516
Regulatory guidances, 448
Regulatory requirements, preformulation studies, 224–225
Relative response factors, parenteral dosage forms, 279
Release testing, parenteral pharmaceuticals, 275–278
Release vs shelf life acceptance criteria, chemical substances, 396
Repeatability, definition, 418
Reproducibility, definition, 419
Research and development (R&D), 2
Research documents, 520–521
Residual solvents, 86–92
 analysis, in-process impurities in parenteral drugs, 279
 in compendial testing, 338
 ICH guidelines, 409–410
Results/statistical packages, analysis of, 493
Retained solvents, in drug substance identification, 188–189
Retention times and structures, EMD, HPLC/UV, 359–360
Revalidation, test methods, 438
Reversed-phase methods, 352–357
Robotics and laboratory automation, solid dosage-form analysis, 262–263
Robustness, definition, 419
Robustness testing, 422
Ruggedness, definition, 419
- Safety and efficacy in patients, in clinical drug development, 3
Safety in healthy subjects, in clinical drug development, 3
Salt form selections, in compound selected for development, 176
Sampling techniques, in setting specifications, 412
Scanning electron microscopy (SEM), 67
Schedules, in stability studies, 457–458
Sensitivity, definition, 419
Separation methods, 346–348
Separation sciences, electrophoretic microchip technology, 529–554
- Separation techniques
 in preformulation studies, 220–222
 solid dosage-form analysis, 237
Setting specifications, 10, 17–18
Sieve analysis, in particle size distribution, 74–77
Single-crystal transmission work, 58
Single refraction, 66
Skin, drug delivery through, 310–311
Small drug molecules, achieved by CE, 546
Small-volume parenteral dosage forms, 271
Sodium metabisulfite, in parenteral formulations, 277
Soft ionization, 130
Solid oral dosage forms, analysis, 10, 13–14
Solid phase libraries, 25
Solid-state analysis, 57–84
Solid-state characteristics, in drug substance identification, 197–206
Solid-state forms, new drug substances, 398–399
Solubility
 aqueous, 191
 in drug substance identification, 190–191
 as function of temperature, 191
 method of determination, 191
 in organic solvents, 191–192
 in preformulation studies, 176
 study of polymorphism, 199–200
Solubilization, in drug substance identification, 192
Solution calorimetry, for thermal analysis, 223
Solution phase libraries, 25
Solvates, of a drug substance, 202–204
Solvents. *see* specific type
Somatostatin agonists, structure-based design, 47–48
Specifications, 387–413
 definition, 387–388
 at different stages of drug development, 389–393
 justification of, 398
 pharmacopeias and, 410–411
 statistical considerations in, 411–412
Specifications and test methods, in drug substance stability programs, 465–467
- Specificity, definition, 419
Spectrofluorometers, 536
Split synthesis, 26
Stability
 criteria, 449–450
 in preformulation studies, 176
 schedules, 450–451
Stability chambers, 451–454
Stability commitments, in drug substance stability programs, 469–470
Stability indicating method development, in drug substance identification, 210
Stability kinetics, expiration date and, in drug substance identification, 211–212
Stability report, documentation in stability studies, 457–459
Stability studies, 10, 19, 445–483
 operational issues, 446–460
Stability testing, 9
 during drug product development, 472–474
Standard operating procedures (SOPs), 8, 489
Statements and labeling, drug product stability testing, 479
Stereochemical structure, 5
Stereochemistry, 5
Sterility testing, parenteral dosage forms, 284
 growth media, 285
 innovations and improvements to, 287–289
 interpretation of results, 286
 limitations to, 287
 number of units sampled, 285
 time and temperature of incubation, 286
 validation and controls for, 286–287
Stomach, drug delivery, 308–309
Storage, 4
Storage and sampling time, in drug substance identification, 210–211
Storage conditions
 in drug substance stability programs, 467–469
 period and, drug product stability testing, 476–477
Strain index, 80–81
Stress testing, 96, 98
 acid/base, 99–101
 in photostability testing, 107

- thermal and thermal/humidity, 101–102
- Structural assignment, methods for, 26–27
- Structure-activity relationships (SAR), 27
- Structure-based design, somatostatin agonists, 47–48
- Structure modifications, in compound selected for development, 175
- Substrate-based fabrication, 533–535
- Supercritical fluid chromatography, as separation technique, 222
- Supercritical liquid chromatography (SFC), separation methods, 376–379
- Surfactants, 192
- Sustained-release products, oral, 185
- Swab selection, parenteral drug products, 298
- Symmetrical extinction, 66
- Synthesis bead, 26–27
- Synthetic small molecule, typical specification for, 392
- System suitability, 425–426
- Tablet and capsule specifications, product release and stability monitoring, 240
- Tapped density, 78
- Target acceptance criteria, for a validation protocol, 434–436
- Technical ownership, transfer of, 494–497
- Technical transfer time line/project plan, 492
- Technician qualification, parenteral drug products, 298
- Technology transfer documents, 8, 517
- Test attributes, procedures, and acceptance criteria, drug product stability testing, 474–475
- Testing frequency drug product stability testing, 476
 - in drug substance stability programs, 469
- Test requirements description, 490–491
 - rationale for, 491
- Test results and raw data, documentation in stability studies, 456–457
- Therapeutic DNA plasmid product, biological licensing for, 183
- Therapeutic-recombinant DNA-derived products, biological licensing for, 183
- Therapeutic synthetic peptide of 40 or fewer amino acids, biological licensing for, 183
- Thermal analytical methods, 70–73
 - physicochemical characterization of solid dosage forms, 246–248
 - preformulation studies, 222–223
- Thermal gravimetric analysis (TGA)
 - in drug substance identification, 187–188
 - solvents, 86
- Thermal gravimetric methods, for thermal analysis, 223
- Thermal microscopy, 66–67
- Thermal reactions, competing with photostability studies, 108–109
- Thermodynamic and physicochemical properties, in drug substance identification, 190–193
- Thermogravimetry (TG), 72–73
- Thermospray, 129
- Thin-layer chromatography (TLC)
 - in-process impurities in parenteral drugs, 279
 - isolation of impurities/degradants, 121–122
 - separation methods, 346–347, 374
 - as separation technique, 220–221
- Time-of-flight instruments, 130
- Total ion current (TIC) chromatogram, 133
- Toxicology formulation, in clinical candidate selection, 504
- Trademarks, 177–178
- Trade secrets, 177–178
- Transdermal patch administration, 186
- Transfer waiver, 488–489
- Triethylamine (TEA), 133
- Trifluoroacetic acid, 132
- Trovafloxacin, 134
- True density, 78
- Ultraviolet (UV) degradation experimental setup, guidelines, 110
- Ultraviolet (UV) exposure, 110
- Ultraviolet (UV) photodiode array, in early phase development, 351–356
- Ultraviolet (UV) spectroscopy
 - in drug substance identification, 187
 - in preformulation studies, 215
- Ultraviolet/visible (UV/VIS) diffuse reflectance spectroscopy, definition of molecules, 58–59
- Uniaxial crystals, 66
- Unimodel model-dependent method, 76
- Unimodel model-independent method, 76
- Unimolecular decomposition, vs granddaughter ions, 140–142
- United States Pharmacopoeia (USP), 4, 394
 - brief history, 326
 - drug substance conditions, 98
 - impurities, 12
 - methodology of microscopic analysis, 66
 - national formulary, 326
 - test for particulate matter, 293
- Universal tests and criteria, chemical substances, 398
- Validatable, transferable, robust, reliable, accurate, and precise (V-TR²AP), 416, 421
- Validation
 - analytical method, 415–443
 - compendial testing, 340–341
 - documentation, 428–429
 - experimentation, 429–436
 - generalization flowchart, 417
 - requirements of the method, 428
 - terminology and definitions, 418–419
- Viability-based technologies, in sterility testing of parenteral drugs, 287–289
- Vibrational spectroscopy, 59–62
- Visible photometry and colorimetry, in preformulation studies, 215

- WALTZ-16, 155
- Water, 92–95
- Waxman-Hatch Act, 182
- 1536-Well technology platform, 41–42
- World Health Organization (WHO), regulatory guidelines, 448
- X-ray diffraction, 67–70
 - in preformulation studies, 217
- X-ray fluorescence, in preformulation studies, 219
- X-ray powder diffraction (XRPD), 69–70
 - physiochemical characterization of solid dosage forms, 244–246